

AIR CLEANING AND DISINFECTION MODULES

UNITS WITHOUT A FAN BUT WITH A RANGE OF CLEANING AND DISINFECTING TECHNOLOGIES

- ALUMINIUM PROFILE STRUCTURE
- HIGH QUALITY, 25 MM THICK ACOUSTICALLY INSULATED CASING
- SIDE PANEL FOR MAINTENANCE ACCESS
- PREFINISHED SHEET
- MODULAR CONSTRUCTION



MF
UNITS WITH FILTERS

MPCO
UNITS WITH PHOTOCATALYSIS
TECHNOLOGY

MCA
UNITS WITH ACTIVATED
CARBON FILTERS

MFE
UNITS WITH
ELECTROSTATIC FILTERS



UNITS WITHOUT A FAN BUT WITH A RANGE OF CLEANING AND DISINFECTION TECHNOLOGIES



MF

Filter units without a fan but offering various filter options



MCA

Filter units without a fan but with activated carbon filter cartridges

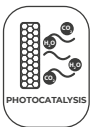

MPCO

Filter units without a fan but with technology based on photocatalysis

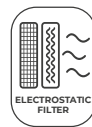
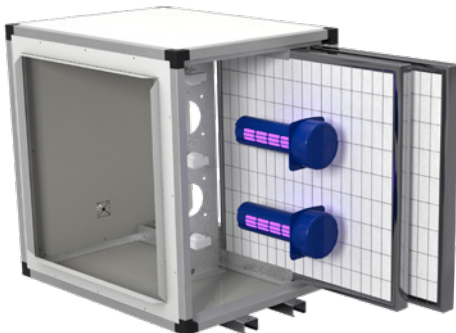

MFE

Filter units without a fan but with high efficiency electrostatic filters

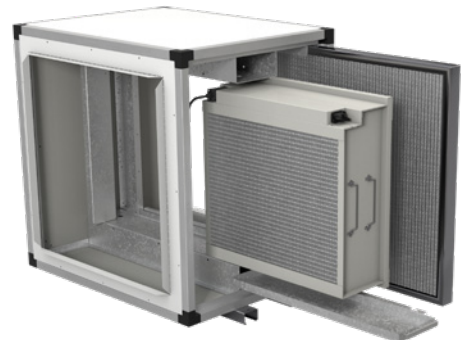

MF

Filter units without a fan but offering various filter options



Filter units without a fan but offering various filter options, designed to clean air by trapping airborne particulate matter present inside buildings.

Characteristics:

- Aluminium profile structure.
- High quality, 25 mm thick acoustically insulated casing made from prefinished sheet.
- Side panel for maintenance access.
- Modular construction for use in combination with different air treatment units.
- Compatible with most existing aluminium profile type models: CJK/EC, CJK/FILTER/EC, UPC/EC, CJBX/AL, CJB/AL, CJDXR/AL, UFRX/ALS...
- Filtration stages options:
 - G4 + F7.
 - F6 + F8.
 - F7 + F9.
- Easy to remove filters for cleaning and maintenance.

Order code

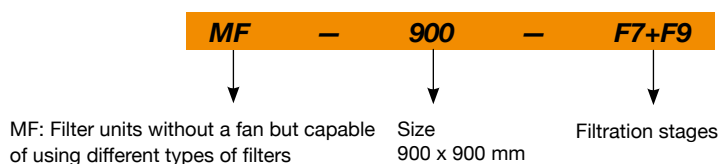

Characteristics of the filters

	EN 779	EN 1822	ISO 16890		
			ISO ePM ₁	ISO ePM _{2.5}	ISO ePM ₁₀
F6	60-80%	-	-	>50-65%	>60%
F7	80-90%	-	>50-65%	>65-80%	>85%
F8	90-95%	-	>65-80%	>80%	>90%
F9	>95%	-	>80%	>95%	>95%

Technical characteristics

	Cross section (mm)		Total weight (kg)	Maximum flow rate (m³/h)
	Height	Width		
MF-490	490	490	16	1813
MF-500	500	500	19	1323
MF-550	550	550	19	2384
MF-605	605	605	21	2970
MF-680	680	680	23	3887
MF-700	700	700	35	2593
MF-855	855	855	41	6464
MF-900	900	900	58	3759
MF-1000	1000	1000	51	8983
MF-1195	1195	1195	73	10372
MF-1250	1250	1250	79	10372
MF-1450	1450	1450	94	15038
MF-1670	1670	1670	105	23338

Installation examples

Set-up next to a ventilation unit

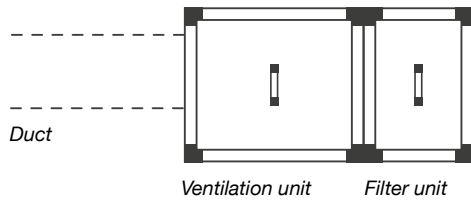

Set-up between ducts

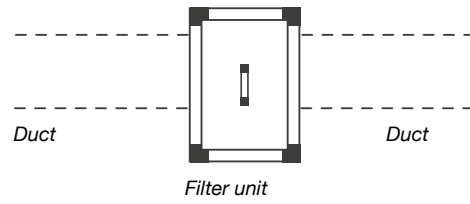

Dimensions mm

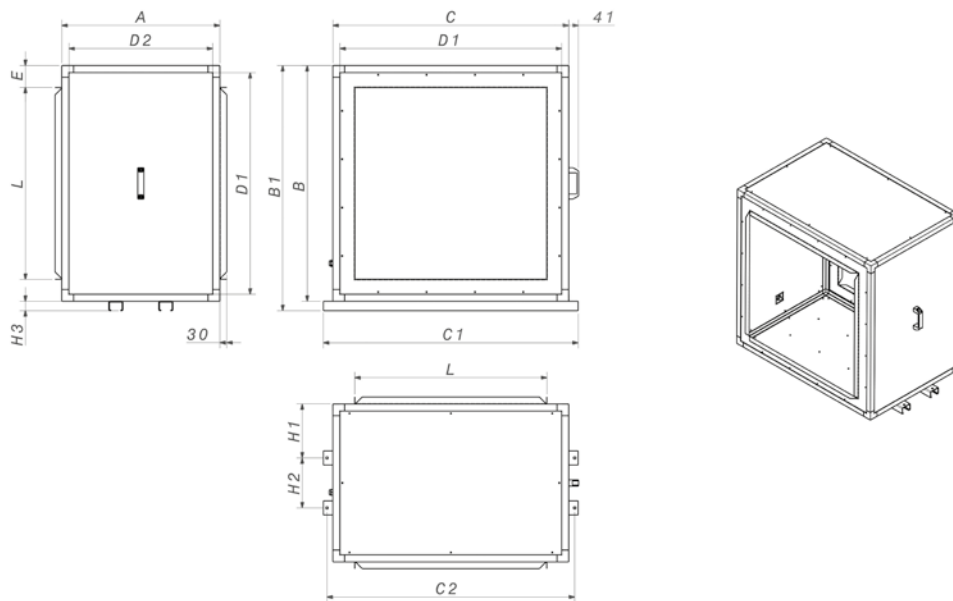

	A	B	B1	C	C1	C2	D1	D2	E	L	H1	H2	H3
MF-490	510	490	-	490	-	-	430	450	83.4	323.2	-	-	-
MF-500	500	500	-	500	-	-	420	420	58.4	383.2	-	-	-
MF-550	510	550	-	550	-	-	490	450	83.4	383.2	-	-	-
MF-605	510	605	-	605	-	-	545	450	106.9	391.2	-	-	-
MF-680	510	680	-	680	-	-	620	450	84.4	511.2	-	-	-
MF-700	700	700	-	700	-	-	620	620	94.4	511.2	-	-	-
MF-855	670	855	895	855	938	908	795	610	84.4	686.2	229	212	40
MF-900	900	900	-	900	-	-	820	820	106.9	686.2	-	-	-
MF-1000	670	1000	1040	1000	1080	1050	940	610	92.9	814.2	229	212	40
MF-1195	670	1195	1235	1195	1280	1245	1115	590	131.9	931.2	229	212	40
MF-1250	670	1250	1290	1250	1350	1320	1170	590	168.9	912.2	229	212	40
MF-1450	670	1450	1490	1450	1550	1520	1370	590	169.4	1111.2	229	212	40
MF-1670	670	1670	1710	1670	1770	1740	1590	590	137.75	1394.5	229	212	40

Accessories

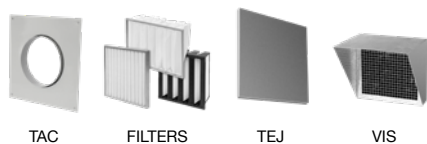

Load loss characteristic curves

Q = Flow rate in m³/h, m³/s and cfm.

Pe = Static pressure in mmH₂O, Pa and inwg.

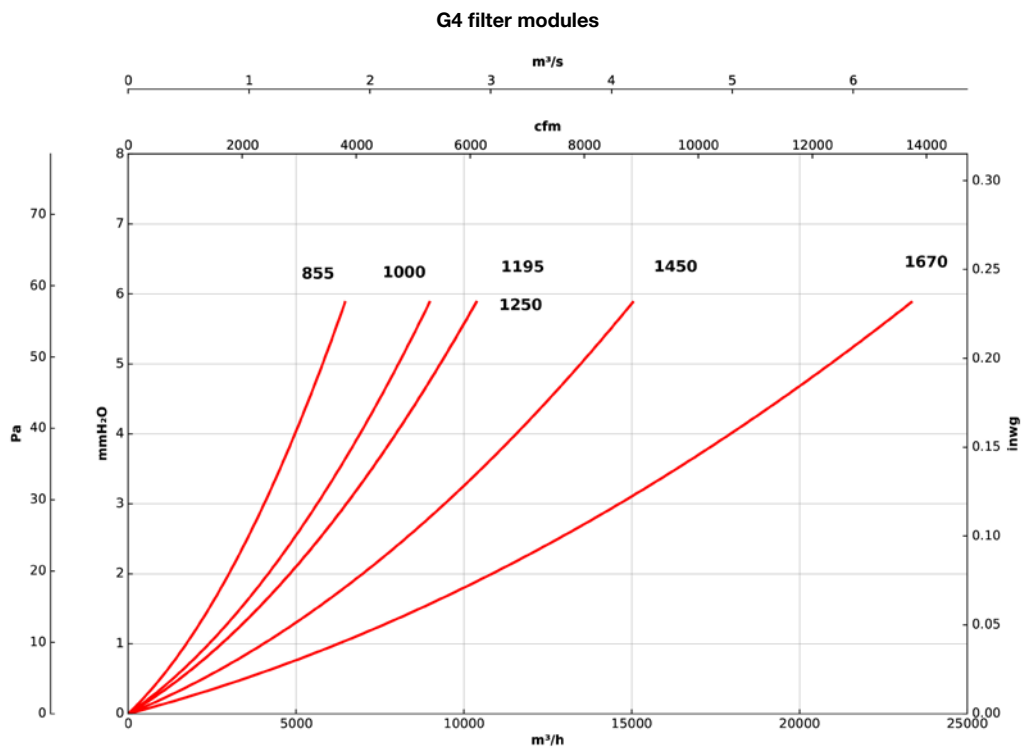
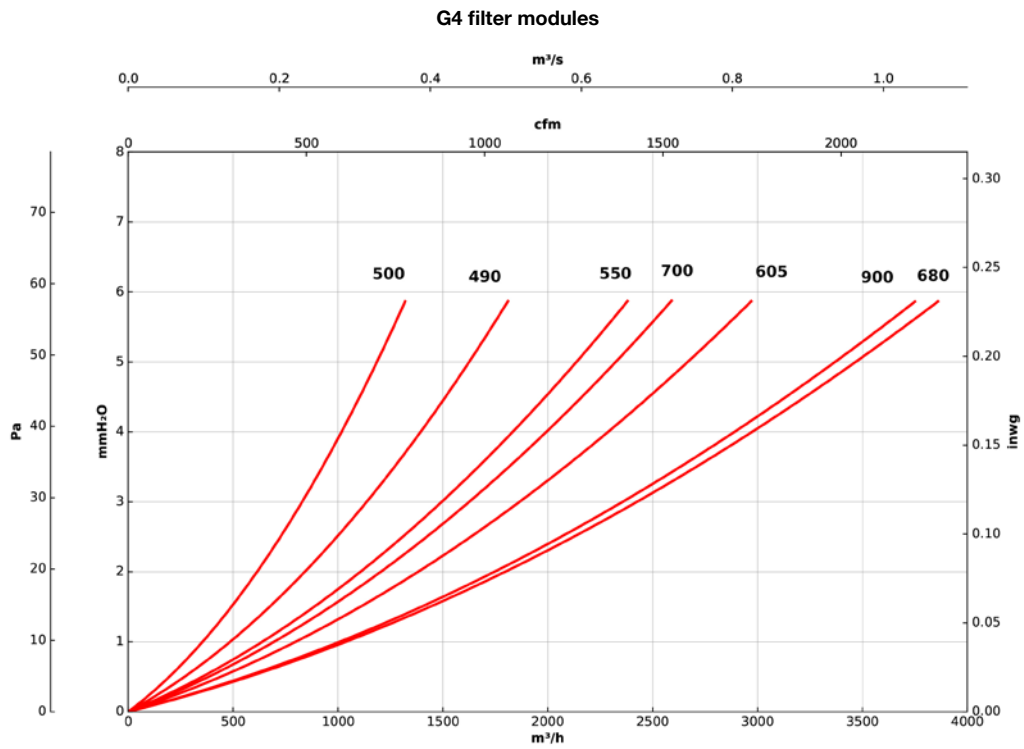

Load loss characteristic curves

Q = Flow rate in m³/h, m³/s and cfm.

Pe = Static pressure in mmH₂O, Pa and inwg.

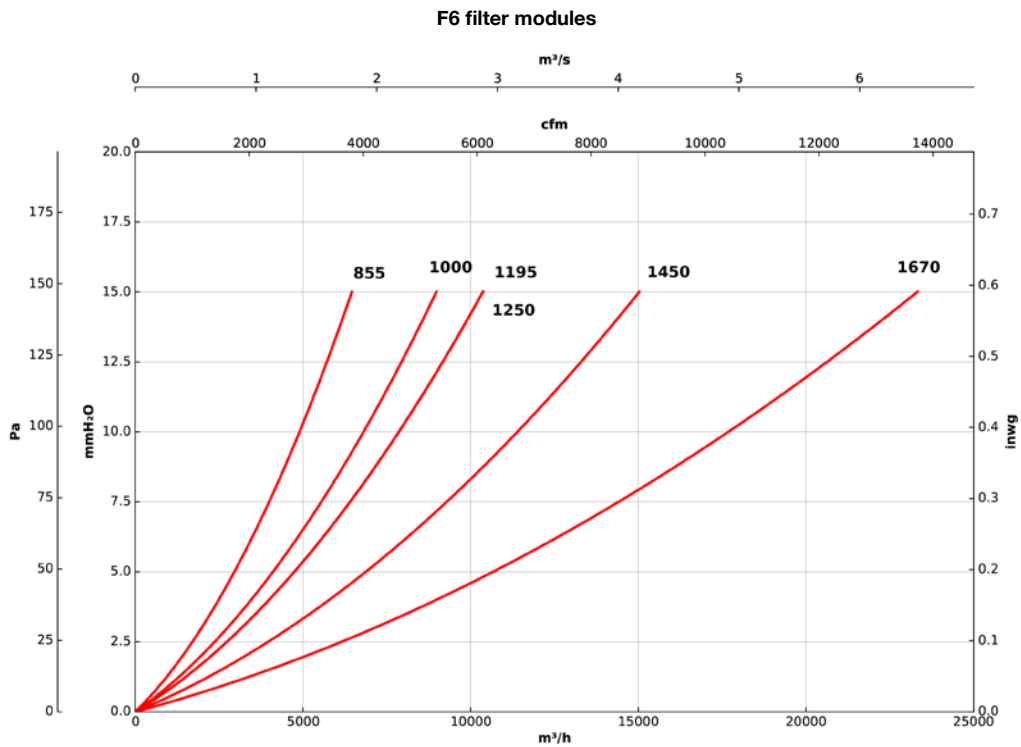
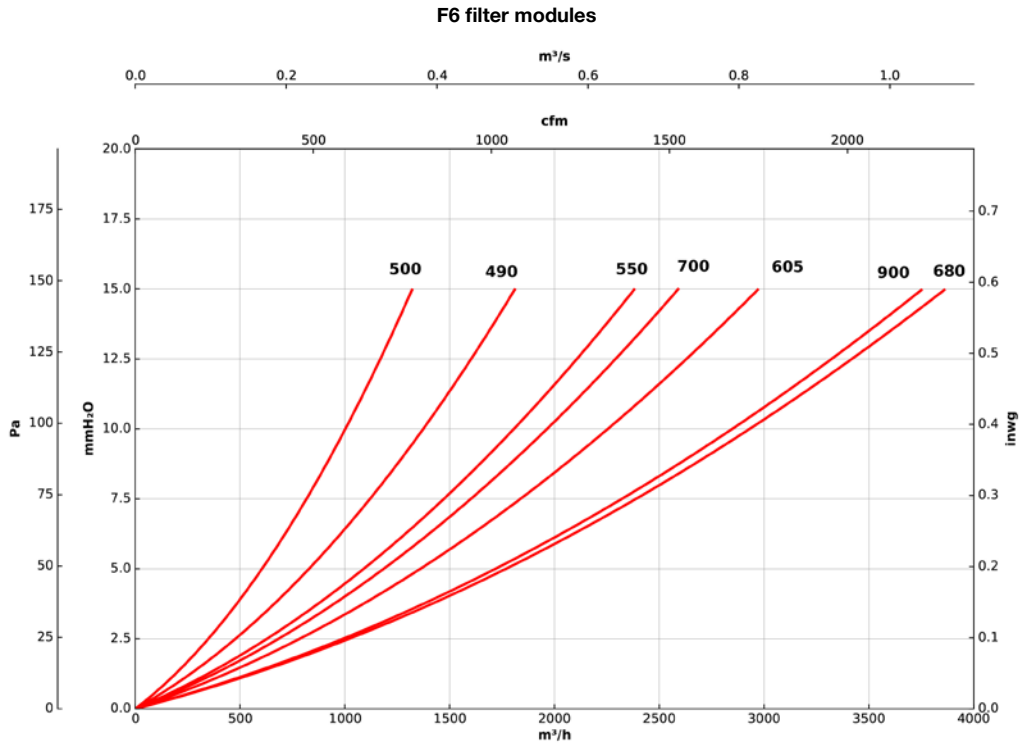

Load loss characteristic curves

Q = Flow rate in m³/h, m³/s and cfm.

Pe = Static pressure in mmH₂O, Pa and inwg.

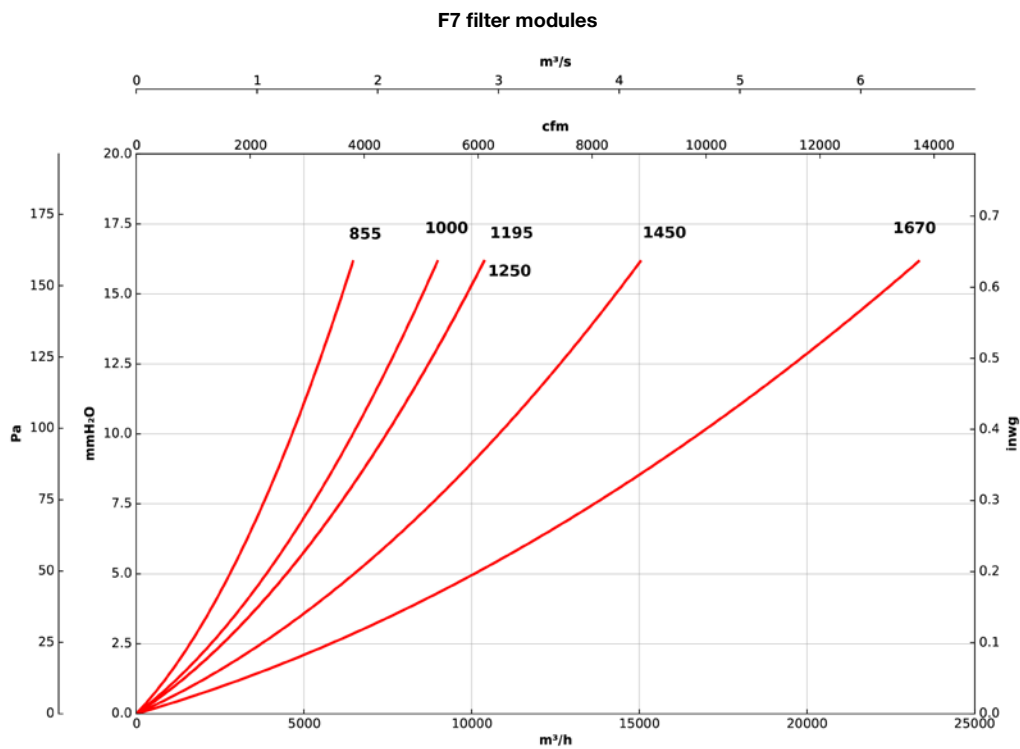
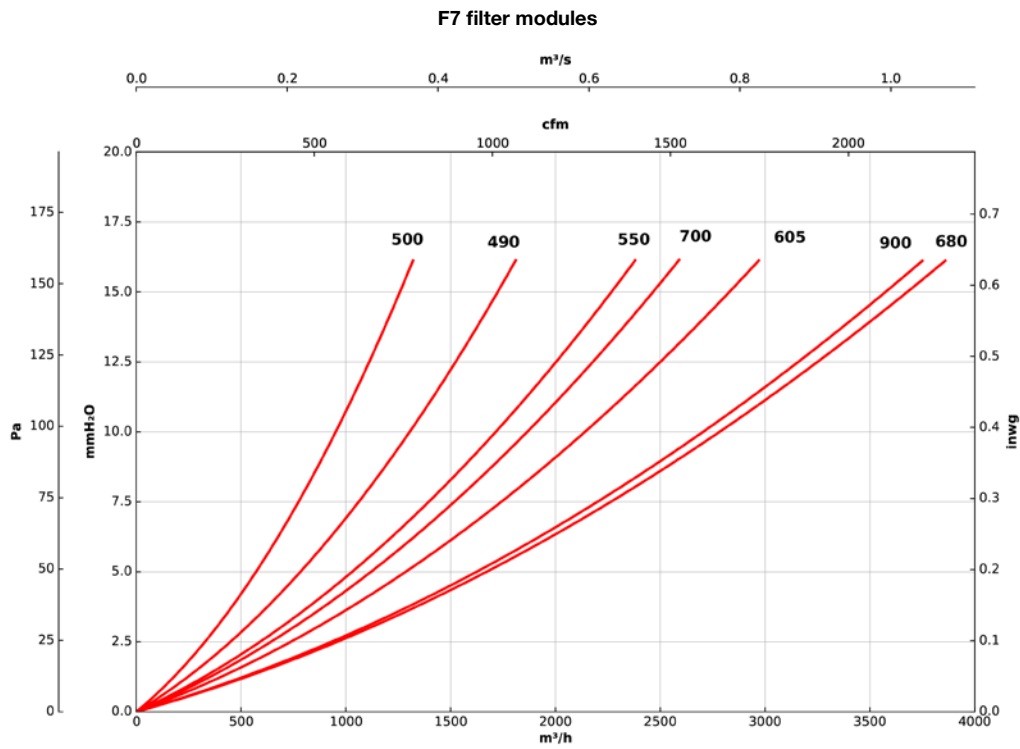

Load loss characteristic curves

Q = Flow rate in m³/h, m³/s and cfm.

Pe = Static pressure in mmH₂O, Pa and inwg.

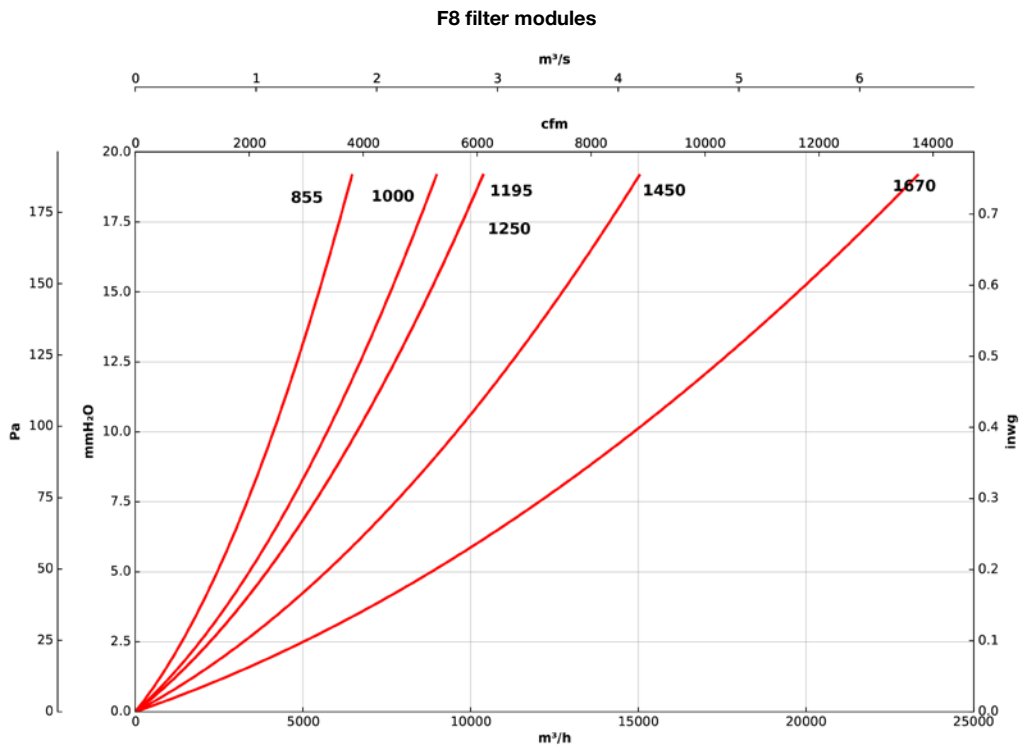
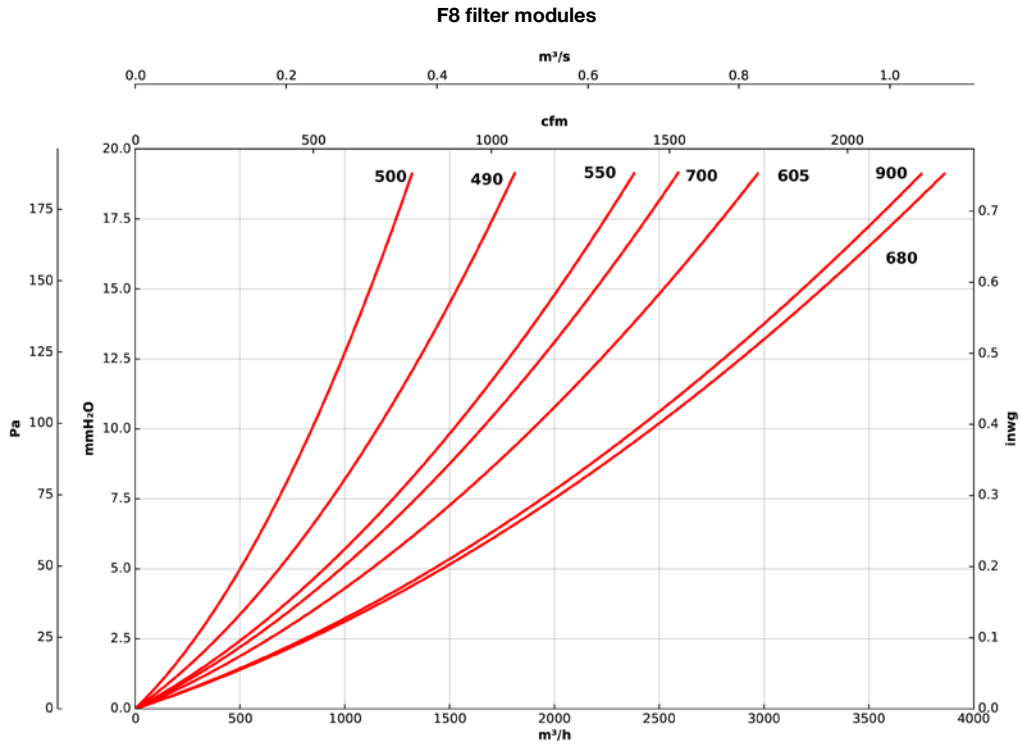

Load loss characteristic curves

Q = Flow rate in m³/h, m³/s and cfm.

Pe = Static pressure in mmH₂O, Pa and inwg.

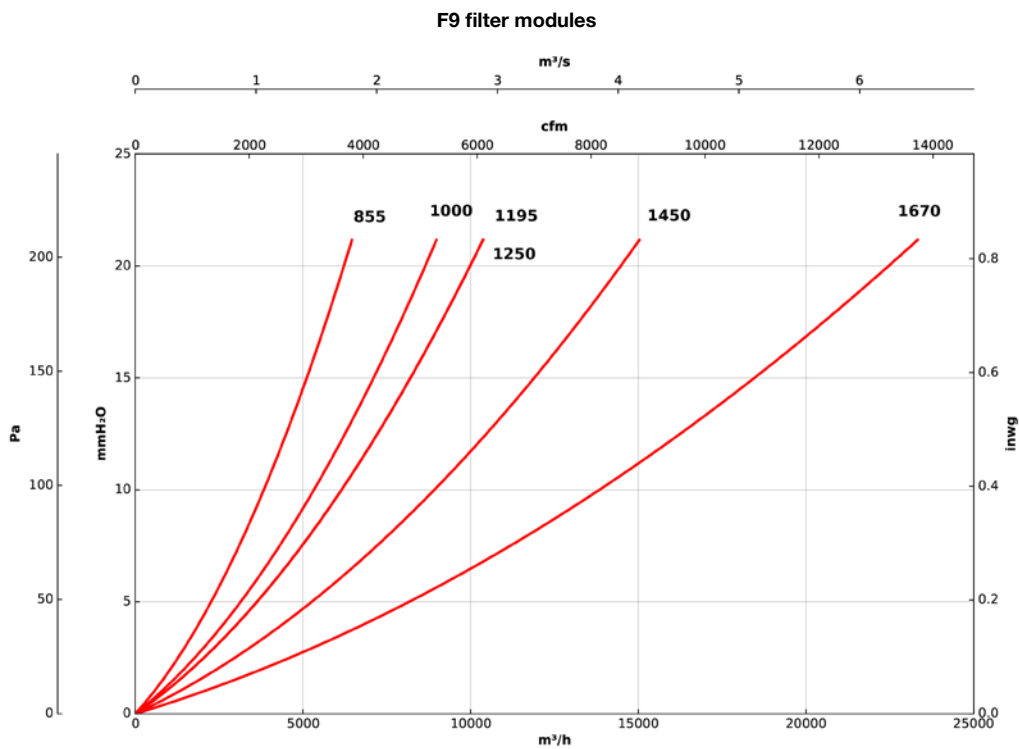
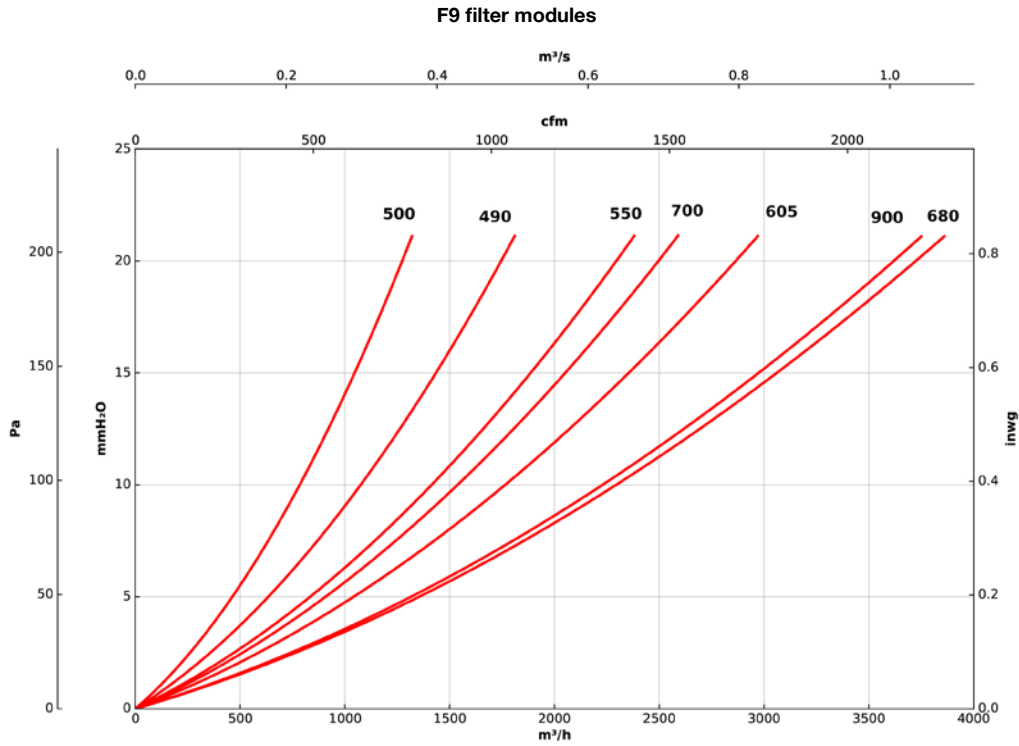

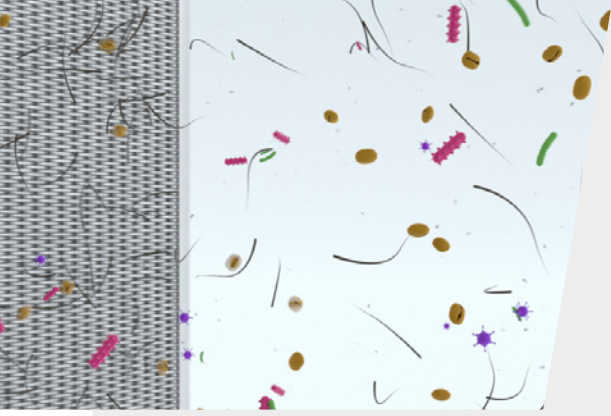

ACTIVATED CARBON FILTERS

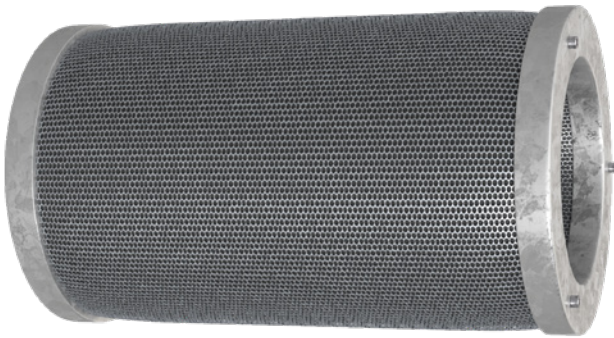

Activated carbon filters are specifically designed for treating large air flows while minimising load loss.

These filters are easy to install and are rechargeable.

Activated carbon filter technology is ideal for removing undesired pollutants, trapping odours, gases and allergens. They are also recommended for purifying pollutants generated by general use and occupation of premises.

RECOMMENDED FOR

- Commercial kitchens
- Airports
- Hospitals
- Agri-food industry
- Fast food restaurants

HOW DOES IT WORK?

Activated carbon filter technology in cartridges works by trapping pollutants and odours present in the air that passes through the filter cartridge.

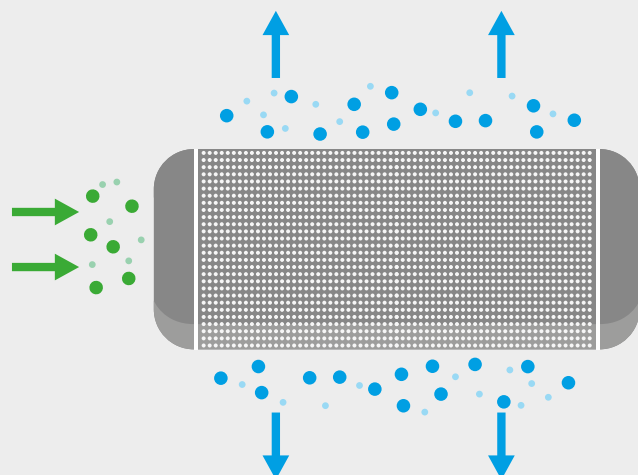

MCA



Filter units without a fan but with activated carbon filter cartridges



Filter units without a fan but with activated carbon filter cartridges, designed for eliminating odours and purifying airborne pollutants.

Characteristics:

- Aluminium profile structure.
- High quality, 25 mm thick acoustically insulated casing made from prefinished sheet.
- Side panel for maintenance access.
- Modular construction for use in combination with different air treatment units.
- Compatible with most existing aluminium profile type models: CJK/EC, CJK/FILTER/EC, UPC/EC, CJBX/AL, CJB/AL, CJD/AL, UFRX/ALS...
- Filters that are rechargeable, corrosion resistant and easy to remove for cleaning and maintenance.

Order code

MCA – 900

MCA: Filter units without a fan but with activated carbon filter cartridges

Size
900 x 900 mm

Characteristics of the filters

ACTIVATED CARBON FILTER (CARTRIDGE) - FCCA

Material	Height A (mm)	Diameter B (mm)	Weight (kg)
Galvanised steel	250	145	2.5

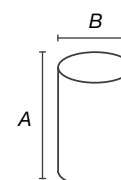

Technical characteristics

	Cross section (mm)		Total weight (kg)	Maximum flow rate (m³/h)
	Height	Width		
MCA-490	490	490	20	1250
MCA-500	500	500	23	1250
MCA-550	550	550	22	1250
MCA-605	605	605	25	1250
MCA-680	680	680	31	2500
MCA-700	700	700	44	2500
MCA-855	855	855	52	3750
MCA-900	900	900	71	3750
MCA-1000	1000	1000	66	5000
MCA-1195	1195	1195	92	8750
MCA-1250	1250	1250	99	10000
MCA-1450	1450	1450	127	13750
MCA-1670	1670	1670	154	20000

Installation examples

Set-up next to a ventilation unit

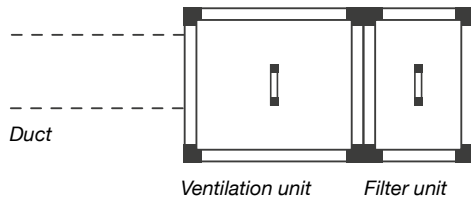

Set-up between ducts

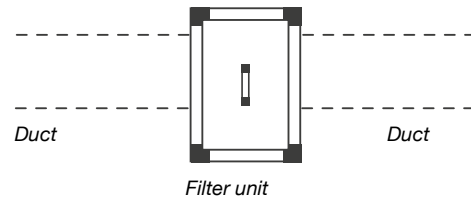

Dimensions mm

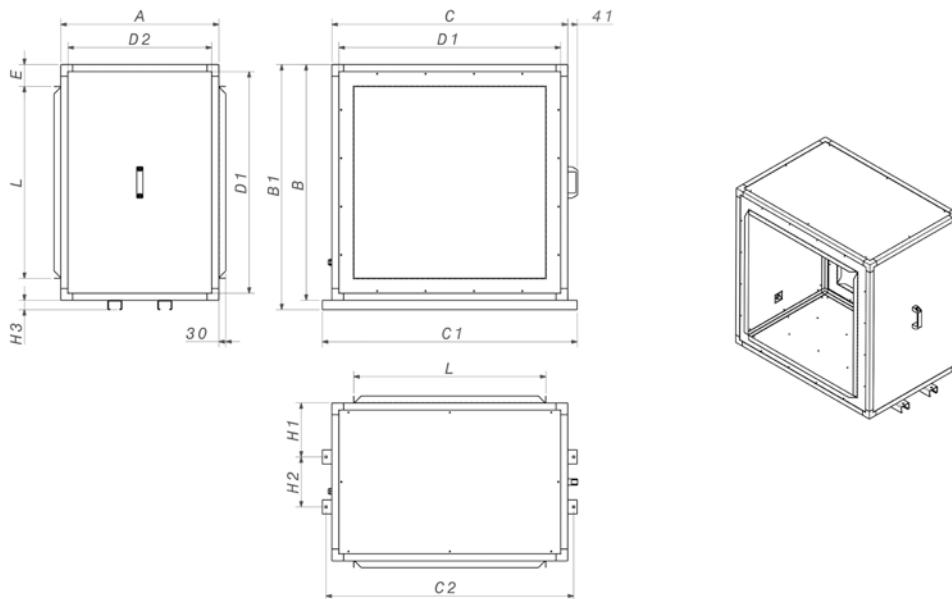

	A	B	B1	C	C1	C2	D1	D2	E	L	H1	H2	H3
MCA-490	510	490	-	490	-	-	430	450	83.4	323.2	-	-	-
MCA-500	500	500	-	500	-	-	420	420	58.4	383.2	-	-	-
MCA-550	510	550	-	550	-	-	490	450	83.4	383.2	-	-	-
MCA-605	510	605	-	605	-	-	545	450	106.9	391.2	-	-	-
MCA-680	510	680	-	680	-	-	620	450	84.4	511.2	-	-	-
MCA-700	700	700	-	700	-	-	620	620	94.4	511.2	-	-	-
MCA-855	670	855	895	855	938	908	795	610	84.4	686.2	229	212	40
MCA-900	900	900	-	900	-	-	820	820	106.9	686.2	-	-	-
MCA-1000	670	1000	1040	1000	1080	1050	940	610	92.9	814.2	229	212	40
MCA-1195	670	1195	1235	1195	1280	1245	1115	590	131.9	931.2	229	212	40
MCA-1250	670	1250	1290	1250	1350	1320	1170	590	168.9	912.2	229	212	40
MCA-1450	670	1450	1490	1450	1550	1520	1370	590	169.4	1111.2	229	212	40
MCA-1670	670	1670	1710	1670	1770	1740	1590	590	137.75	1394.5	229	212	40

Accessories

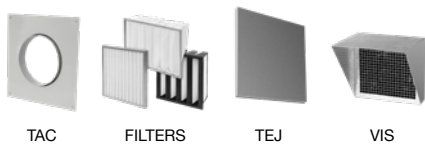

TAC

FILTERS

TEJ

VIS

Load loss characteristic curves

Q = Flow rate in m³/h, m³/s and cfm.

Pe = Static pressure in mmH₂O, Pa and inwg.

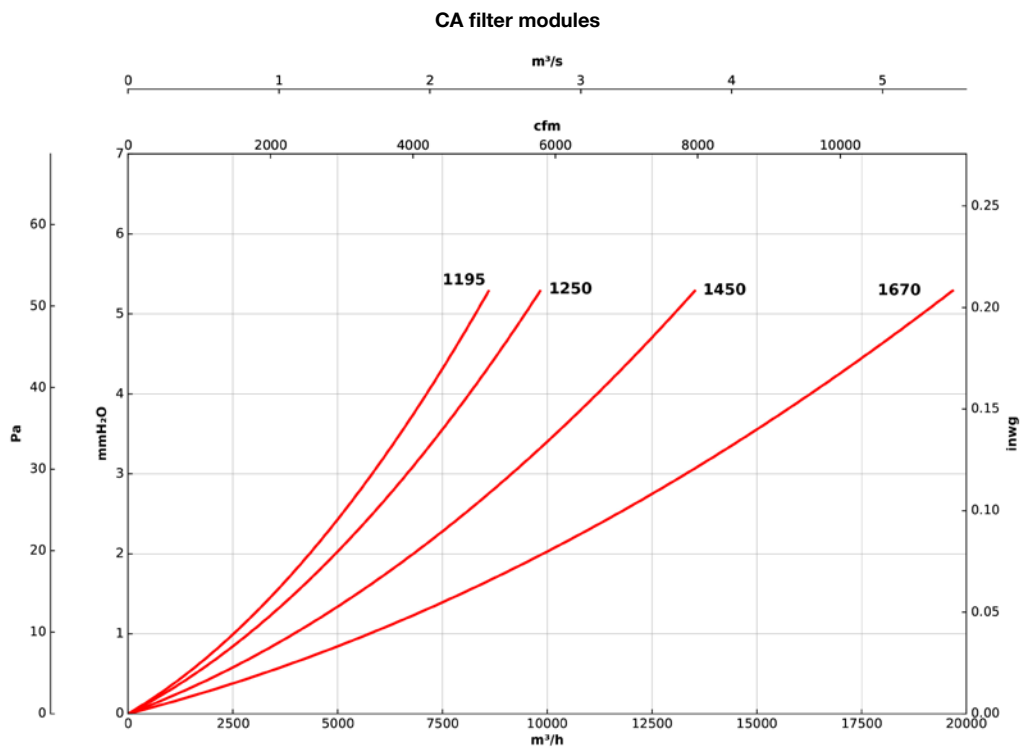
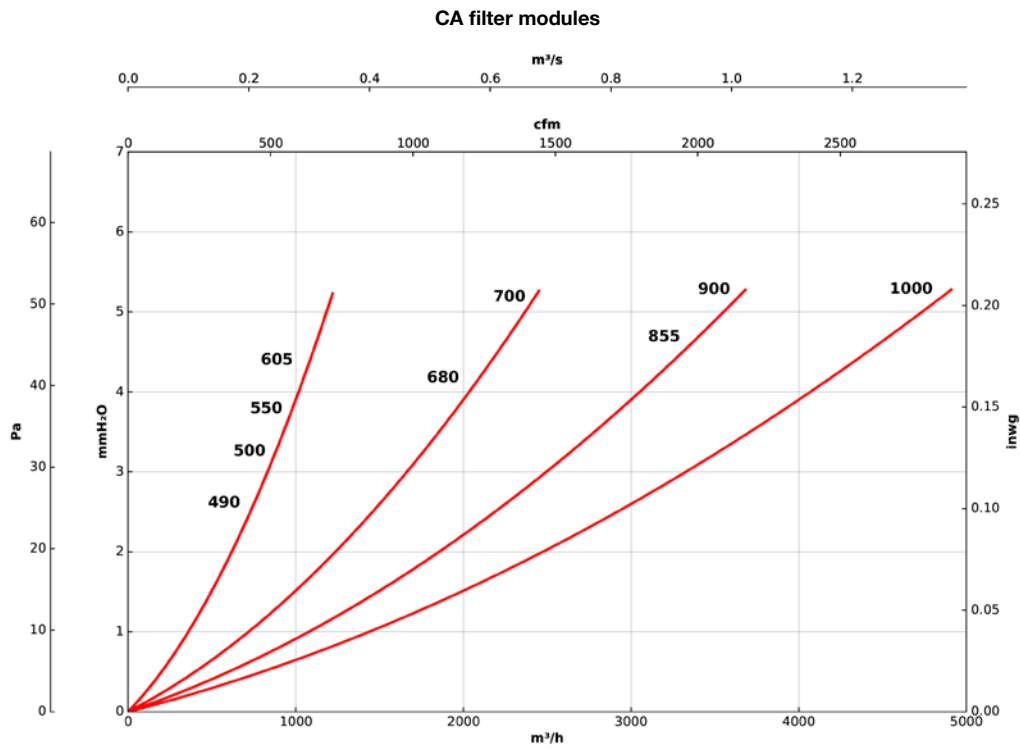

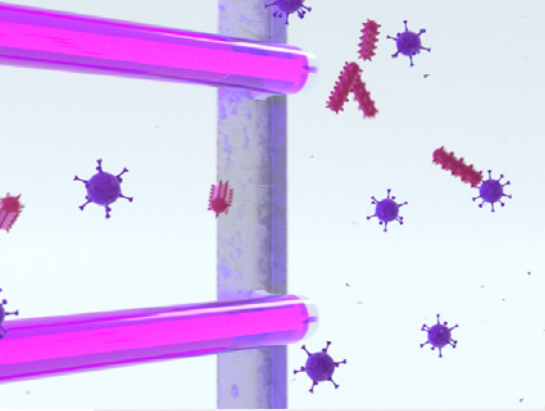

PHOTOCATALYSIS TECHNOLOGY

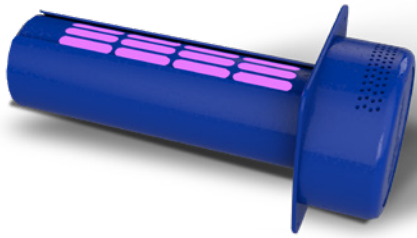

PCO™ technology (Photocatalytic Oxidation) is a powerful tool that is used for purifying air and nearby surfaces, by accelerating the natural decomposition of organic matter through photocatalysis. Additionally, our equipment has built-in modules with **positive and negative ionisation technology**, which improve their purifying efficacy against ultra-fine dust and odours.

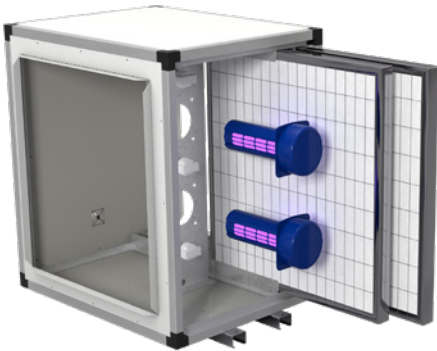

APPLICATIONS

Purifying air by disinfecting it using **PCO technology is ideal for premises where people are continuously entering and exiting**. These premises require a speedy, high efficiency disinfection due to the high rate of pollutants that may be circulating. PCO technology is also suitable for use at locations where there is a need to disinfect large material surfaces through the air.

HOW DOES IT WORK?

PCO technology uses a UVC ultraviolet light source to react with a titanium dioxide catalyst in the presence of humidity/water vapour to create hydroxyl radicals (OH) and hydrogen peroxide (H₂O₂), which inactivate airborne microorganisms and harmful chemical substances circulating in the air.

These devices use PCO technology, together with **positive and negative ionisation**, to gather suspended particulate matter, which has not been collected by filters, and make it harmless.

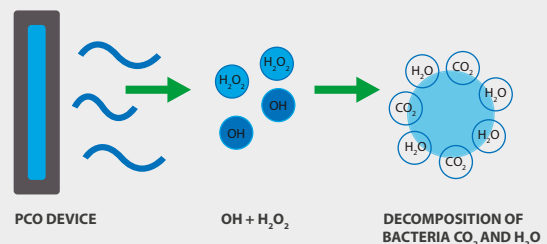

Positive and negative ionisation of particles

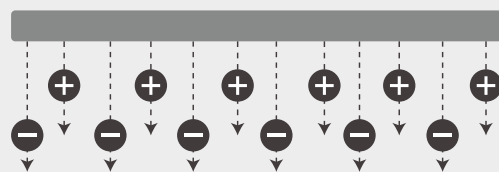

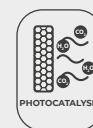

MPCO

Filter units without a fan but with technology based on photocatalysis



Filter units without a fan but with technology based on photocatalysis, especially designed for cleaning, disinfecting and purifying air in indoor spaces as well as material surfaces.

Characteristics:

- Aluminium profile structure.
- High quality, 25 mm thick acoustically insulated casing made from prefinished sheet.
- Side panel for maintenance access.
- Modular construction for use in combination with different air treatment units.
- Compatible with most existing aluminium profile type models: CJK/EC, CJK/FILTER/EC, UPC/EC, CJBX/AL, CJB/AL, CJD/AL, CJD/AL, UFRX/ALS, etc.
- Devices with built-in high-efficiency photocatalysis technology.
- Positive and negative ionisation.
- Filtration stages: F7 + F9.
- Effective up to 40 linear metres of ducting.

Order code

MPCO – 900

MPCO: Filter units without a fan but with technology based on photocatalysis

Size
900 x 900 mm

Technical characteristics

	Cross section (mm)		Total weight (kg)	Maximum flow rate (m ³ /h)	Electrical consumption (W)
	Height	Width			
MPCO-490	490	490	53	1813	14
MPCO-500	500	500	60	1323	14
MPCO-550	550	550	61	2384	14
MPCO-605	605	605	68	2970	14
MPCO-680	680	680	74	3887	14
MPCO-700	700	700	111	2593	14
MPCO-855	855	855	127	6464	28
MPCO-900	900	900	178	3759	14
MPCO-1000	1000	1000	159	8983	28
MPCO-1195	1195	1195	221	10372	42
MPCO-1250	1250	1250	237	10372	42
MPCO-1450	1450	1450	284	15038	56
MPCO-1670	1670	1670	321	23338	84

Installation examples

Set-up next to a ventilation unit

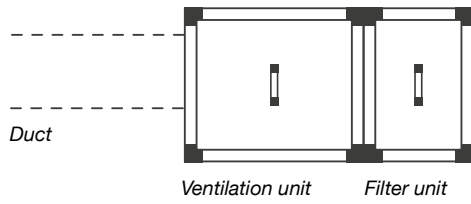

Set-up between ducts

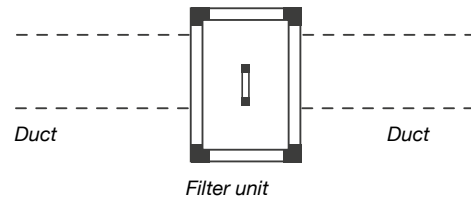

Dimensions mm

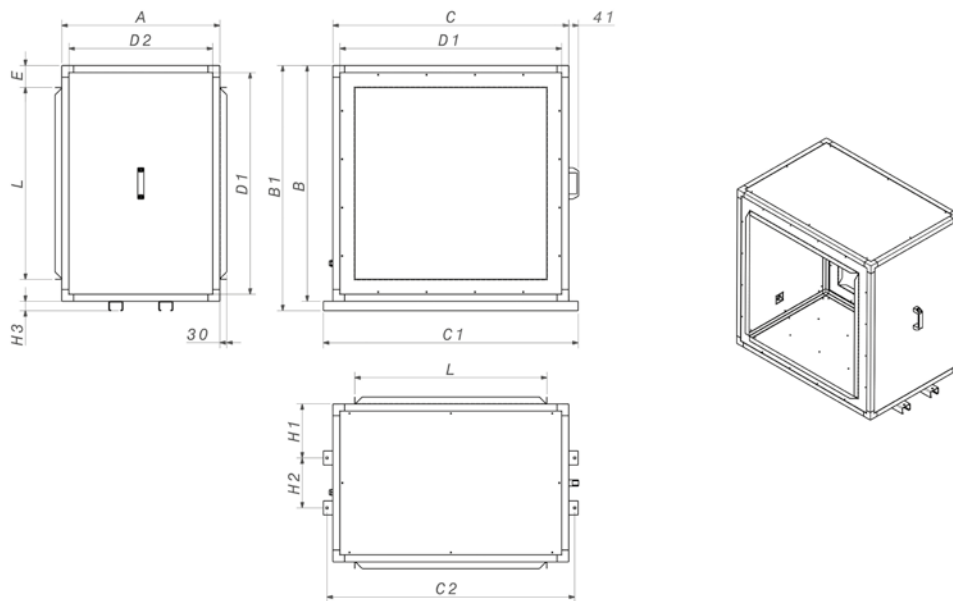

	A	B	B1	C	C1	C2	D1	D2	E	L	H1	H2	H3
MPCO-490	510	490	-	490	-	-	430	450	83.4	323.2	-	-	-
MPCO-500	500	500	-	500	-	-	420	420	58.4	383.2	-	-	-
MPCO-550	510	550	-	550	-	-	490	450	83.4	383.2	-	-	-
MPCO-605	510	605	-	605	-	-	545	450	106.9	391.2	-	-	-
MPCO-680	510	680	-	680	-	-	620	450	84.4	511.2	-	-	-
MPCO-700	700	700	-	700	-	-	620	620	94.4	511.2	-	-	-
MPCO-855	670	855	895	855	938	908	795	610	84.4	686.2	229	212	40
MPCO-900	900	900	-	900	-	-	820	820	106.9	686.2	-	-	-
MPCO-1000	670	1000	1040	1000	1080	1050	940	610	92.9	814.2	229	212	40
MPCO-1195	670	1195	1235	1195	1280	1245	1115	590	131.9	931.2	229	212	40
MPCO-1250	670	1250	1290	1250	1350	1320	1170	590	168.9	912.2	229	212	40
MPCO-1450	670	1450	1490	1450	1550	1520	1370	590	169.4	1111.2	229	212	40
MPCO-1670	670	1670	1710	1670	1770	1740	1590	590	137.75	1394.5	229	212	40

Accessories

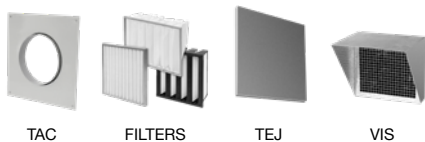

Load loss characteristic curves

Q = Flow rate in m³/h, m³/s and cfm.

Pe = Static pressure in mmH₂O, Pa and inwg.

MCPO F7+F9 filter modules

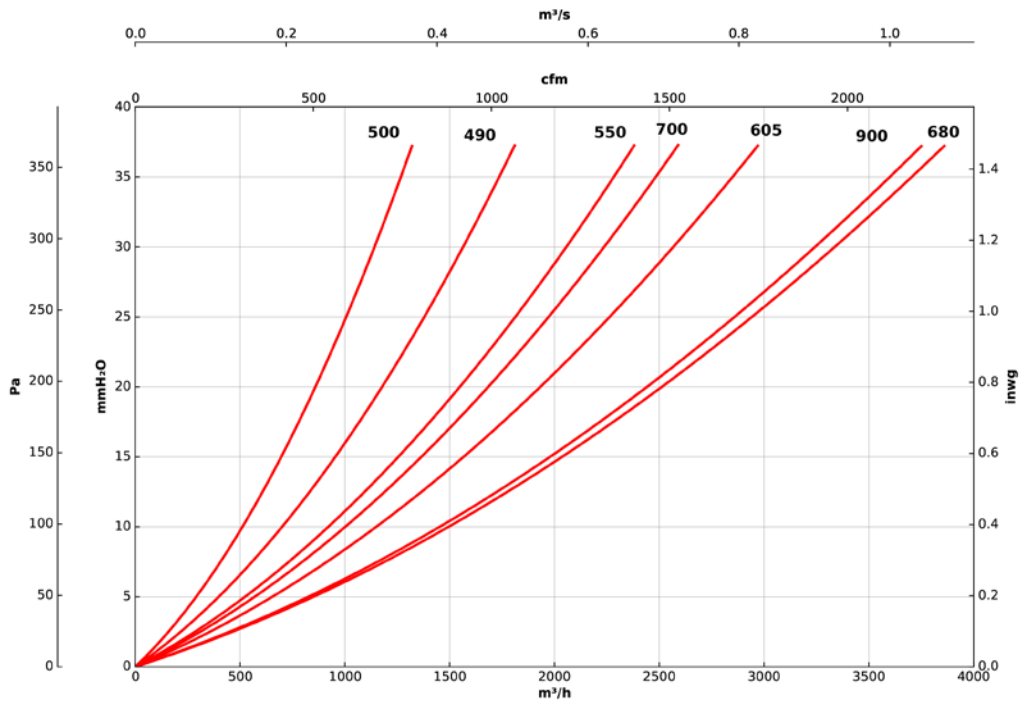

MCPO F7+F9 filter modules

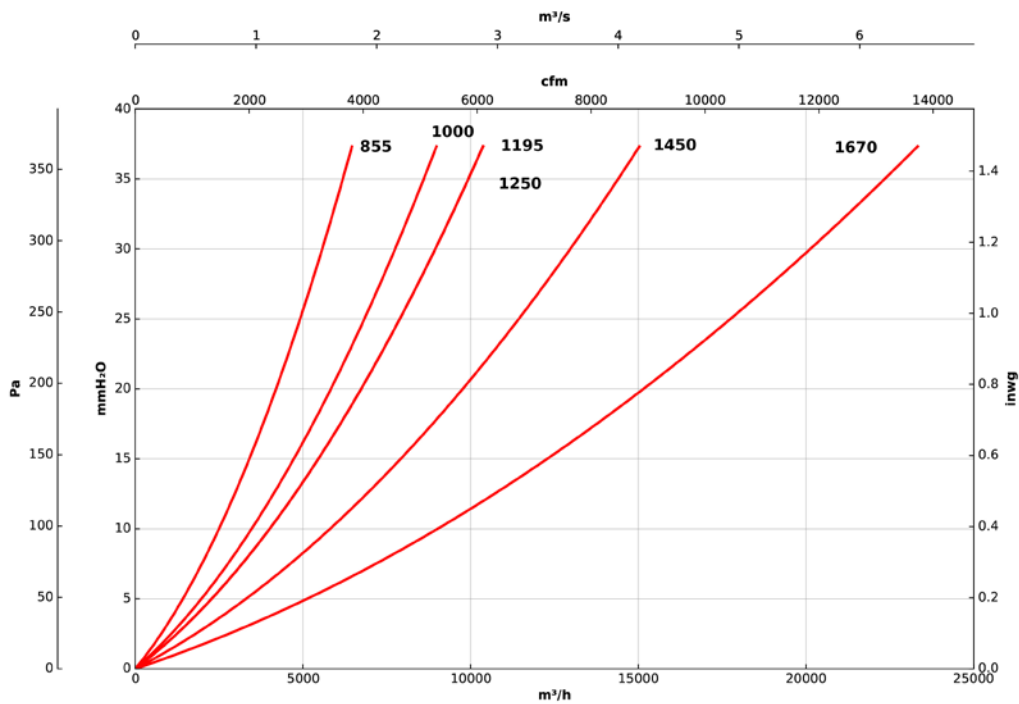

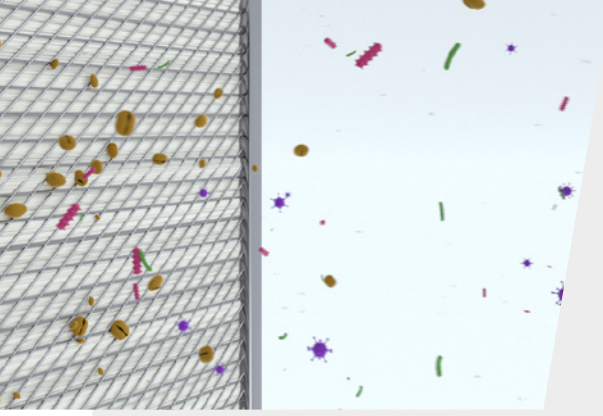

ELECTROSTATIC FILTER TECHNOLOGY

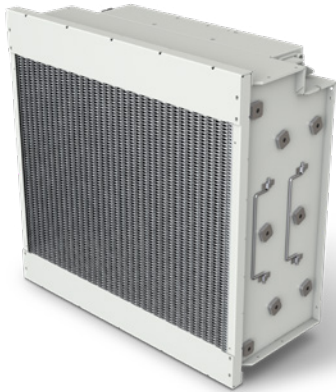

Electrostatic filters EF are especially suitable for eliminating polluting substances such as particulate matter, bacteria or volatile organic compounds (VOCs). The high performance of these filters along with their high capacity for capturing particles, results in this equipment operating with a very low load loss and therefore, their energy consumption is very low in comparison with that of conventional mechanical filtering systems.

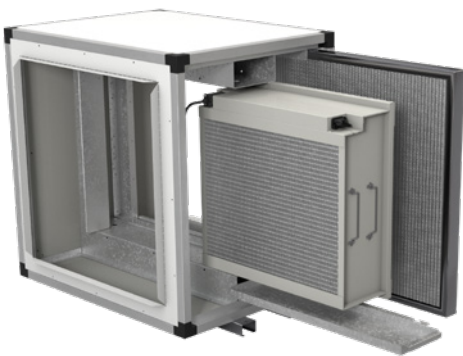

Air purification by disinfection using **electrostatic filter technology** is ideal for environments where pollutants are suspended particulate matter, oily or greasy or of the type that quickly saturate mechanical or fabric filters. Electrostatic filters are washable and easy to maintain.

HOW DOES IT WORK?

Particulate matter is ionised and becomes adhered to oppositely charged collector cells and this way, they are removed from the outlet airflow.

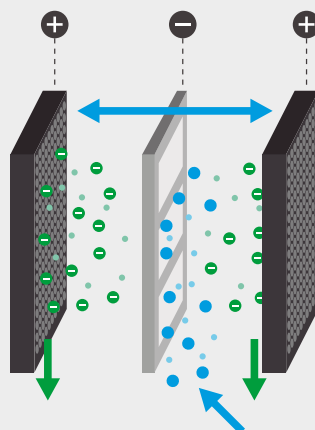

RECOMMENDED FOR

- Commercial kitchens
- Hospitals
- Use in the agri-food sector
- Factories
(suspended particulate matter and smoke up to 20 mg/m³)
- Fast food restaurants
- Chemical and metallurgy industry

MFE

Filter units without a fan but with high efficiency electrostatic filters

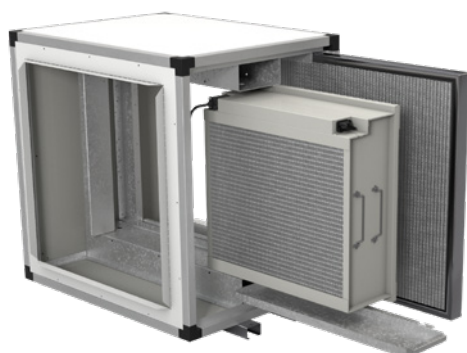

Filter units without a fan but with high efficiency electrostatic filters that are especially designed for cleaning, disinfecting and purifying indoor air at locations containing a high amount of grease or suspended particulate matter.

Characteristics:

- Aluminium profile structure.
- High quality, 25 mm thick acoustically insulated casing made from prefinished sheet.
- Inspection panel for maintenance and filter replacement (minimum recommended opening on the side of 1 m).
- Modular construction for use in combination with different air treatment units.
- Supply voltage 230 V 50 Hz.
- Compatible with most existing aluminium profile type models: CJK/EC, CJK/FILTER/EC, UPC/EC, CJBX/AL, CJBD/AL, CJDXR/AL, UFRX/ALS, etc.
- Washable, anti-grease pre-filter.
- High efficiency (95% ePM₁) electrostatic filter device with built-in thermal sensor.
- Grease-collection trays.

Order code

MFE — 900

MFE: Filter units without a fan but with high efficiency electrostatic filters

Size
900 x 900 mm

Characteristics of the filters

ELECTROSTATIC FILTER

	ePM ₁				
	95%	90%	80%	70%	
Filtration class EN 779	-	-	F9	F8	F7
Air speed (m/s)	1	2	2.5	3	4
Air flow capacity (%)	40	50	65	75	100
Pressure drop (Pa)	10	17	24	37	64

Technical characteristics

	Cross section (mm)		Total weight (kg)	Maximum flow rate (m ³ /h)	Electrical consumption (W)
	Height	Width			
MFE-490	490	490	45	700	9
MFE-500	500	500	41	700	9
MFE-550	550	550	50	700	9
MFE-605	605	605	60	900	9
MFE-680	680	680	73	2100	16
MFE-700	700	700	97	2100	16
MFE-855	855	855	118	3400	16
MFE-900	900	900	153	3400	16
MFE-1000	1000	1000	185	4900	43
MFE-1195	1195	1195	252	8400	64
MFE-1250	1250	1250	274	9320	64
MFE-1450	1450	1450	330	13600	64
MFE-1670	1670	1670	424	19500	109

Installation examples

Set-up next to a ventilation unit

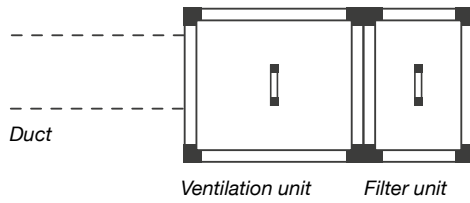

Set-up between ducts

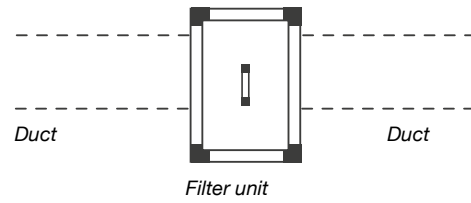

Dimensions mm

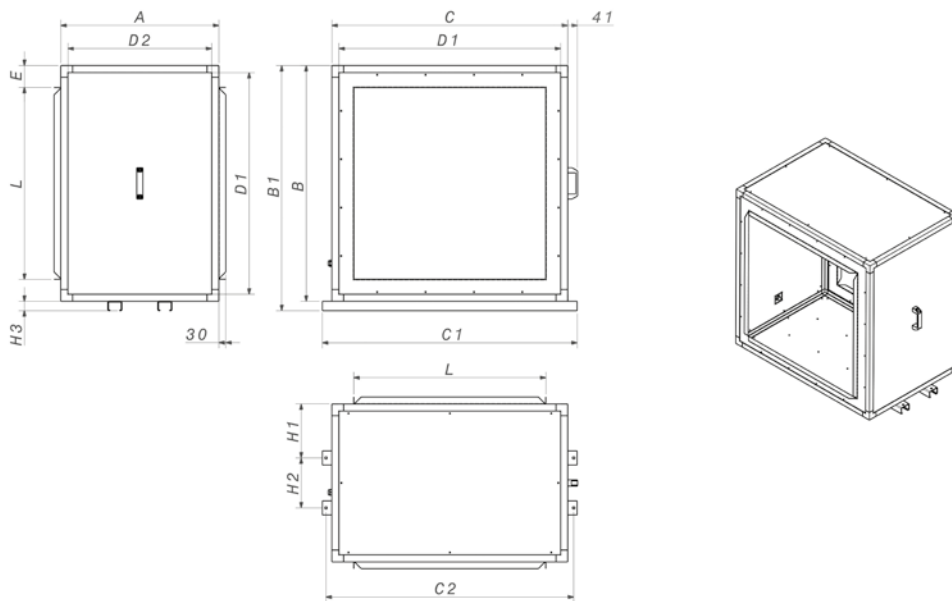

	A	B	B1	C	C1	C2	D1	D2	E	L	H1	H2	H3
MFE-490	510	490	-	490	-	-	430	450	83.4	323.2	-	-	-
MFE-500	500	500	-	500	-	-	420	420	58.4	383.2	-	-	-
MFE-550	510	550	-	550	-	-	490	450	83.4	383.2	-	-	-
MFE-605	510	605	-	605	-	-	545	450	106.9	391.2	-	-	-
MFE-680	510	680	-	680	-	-	620	450	84.4	511.2	-	-	-
MFE-700	700	700	-	700	-	-	620	620	94.4	511.2	-	-	-
MFE-855	670	855	895	855	938	908	795	610	84.4	686.2	229	212	40
MFE-900	900	900	-	900	-	-	820	820	106.9	686.2	-	-	-
MFE-1000	670	1000	1040	1000	1080	1050	940	610	92.9	814.2	229	212	40
MFE-1195	670	1195	1235	1195	1280	1245	1115	590	131.9	931.2	229	212	40
MFE-1250	670	1250	1290	1250	1350	1320	1170	590	168.9	912.2	229	212	40
MFE-1450	670	1450	1490	1450	1550	1520	1370	590	169.4	1111.2	229	212	40
MFE-1670	670	1670	1710	1670	1770	1740	1590	590	137.75	1394.5	229	212	40

Accessories

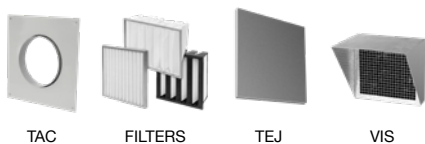

TAC

FILTERS

TEJ

VIS

Load loss characteristic curves

Q = Flow rate in m³/h, m³/s and cfm.

Pe = Static pressure in mmH₂O, Pa and inwg.

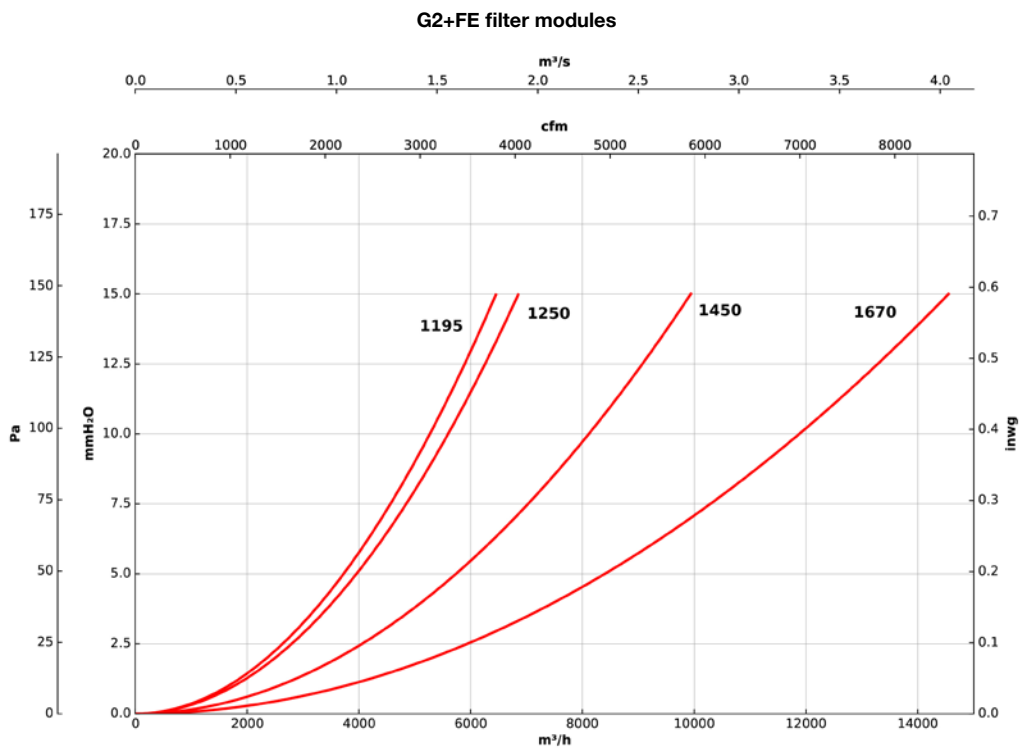
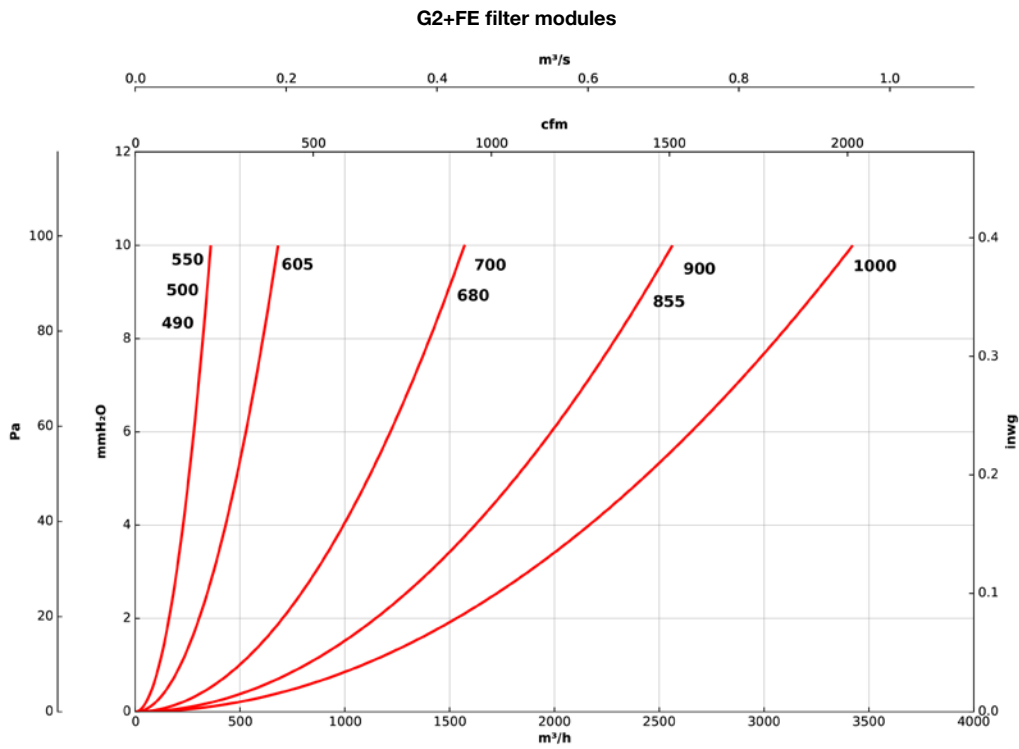



HEADQUARTERS
Sodeca, S.L.U.

Pol. Ind. La Barricona
Carrer del Metall, 2
E-17500 Ripoll
Girona, SPAIN
Tel. +34 93 852 91 11
Fax +34 93 852 90 42
General sales: comercial@sodeca.com
Export sales: ventilation@sodeca.com

PRODUCTION PLANT
Sodeca, S.L.U.

Ctra. de Berga, km 0,7
E-08580 Sant Quirze de Besora
Barcelona, SPAIN
Tel. +34 93 852 91 11
Fax +34 93 852 90 42
General sales: comercial@sodeca.com
Export sales: ventilation@sodeca.com

SODECA Group

EUROPE

FINLAND
Sodeca Finland, Oy

HUITTINEN
Sales and Warehouse
Mr. Kai Yli-Sipilä
Metsälinnankatu 26
FI-32700 Huittinen
Tel. + 358 400 320 125
orders.finland@sodeca.com

HELSINKI
Smoke Control Solutions
Mr. Antti Kontkanen
Vilppulantie 9C
FI-00700 Helsinki
Tel. +358 400 237 434
akontkanen@sodeca.com

HYVINKÄÄ
Industrial Applications
Mr. Jaakko Tomperi
Niinistökatu 12
FI-05800 Hyvinkää
Tel. +358 451 651 333
jtomperi@sodeca.com

ITALIA
Marelli Ventilazione, S.R.L.

Viale del Lavoro, 28
37036 San Martino B.A.
(VR), ITALY
Tel. +39 045 87 80 140
vendite@sodeca.com

PORTUGAL
Sodeca Portugal, Unip. Lda.

PORTO
Rua Vello Salgado
1120/1138
4450-801 Leça de Palmeira
Tel. +351 229 991 100
geral@sodeca.pt

LISBOA
Pq. Emp. da Granja Pav. 29
2625-607 Vialonga
Tel. +351 219 748 491
geral@sodeca.pt

ALGARVE
Rua da Alegria, 33
8200-569 Ferreiras
Tel. +351 289 092 586
geral@sodeca.pt

UNITED KINGDOM
Sodeca Fans UK, Ltd.

Mr. Mark Newcombe
Tamworth Enterprise Centre
Philip Dix House, Corporation
Street, Tamworth, B79 7DN
UNITED KINGDOM
Tel. +44 (0) 1827 216 109
sales@sodeca.co.uk

AMERICA

CHILE
Sodeca Ventiladores, SpA.

Sra. Sofía Ormazábal
Santa Bernardita 12.005
(Esquina con Puerta Sur)
Bodegas 24 a 26,
San Bernardo, Santiago, CHILE
Tel. +56 22 840 5582
ventas.chile@sodeca.com

COLOMBIA
Sodeca Latam, S.A.S.

Sra. Luisa Stella Prieto
Calle7 No. 13 A-44
Manzana 4 Lote1, Montana
Mosquera, Cundinamarca
Bogotá, COLOMBIA
Tel. +57 1 756 4213
ventascolombia@sodeca.co

PERU
Sodeca Perú, S.A.C.

Sr. Jose Luis Jiménez
C/ Mariscal Jose Luis de
Orbegoso 331. Urb. El pino,
15022, San Luis. Lima, PERU
Tel. +51 1 326 24 24
Cel. +51 994671594
comercial@sodeca.pe

RUSSIA

RUSSIA
Sodeca, L.L.C.

Mr. Stanislav Alifanov
Severnoye Shosse, 10 room 201
Business Park Plaza Ramstars
140105 Ramenskoye,
Moscow region, RUSSIA
Tel. +7 495 955 90 50
alifanov@sodeca.com



www.sodeca.com

