

SOLUTIONS IN SMOKE EXHAUST

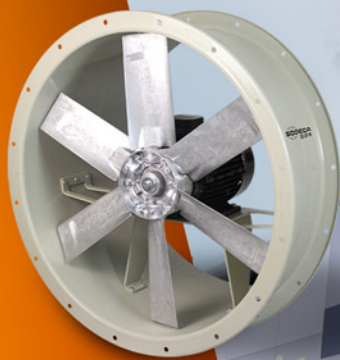

EN-12101-3
POWERED SMOKE AND HEAT
EXHAUST VENTILATORS FOR USE
IN CONSTRUCTION WORKS





SODECA offers solutions in industrial ventilation, smoke exhaust, staircase pressurisation and improving indoor air quality.





Our quality procedures, certified in accordance with ISO 9001:2015, have placed Grupo SODECA as one of the best and most recognised fan manufacturers in the world.

As a result of the expansion process and consolidation of the business, in 2018 we inaugurated the new headquarters located in Ripoll, a municipality near Barcelona.

These new installations have a surface area of more than 15,000 m², distributed into offices, customer service area, warehouse and production area.

Currently, SODECA has become an international leader in the ventilation sector; primarily for its solutions in fire protection, smoke exhaust and staircase pressurisation and evacuation routes.

SYSTEMS FOR CONTROLLING SMOKE IN THE EVENT OF FIRE

"80% of fire victims are a result of the harmful effects of smoke: toxic inhalation, temperature, asphyxia and lack of visibility".

Controlling smoke in the event of a fire **is essential in order to evacuate people and for fire-fighters to extinguish the fire, helping to create smoke free zones or ensuring the temperature and visibility are suitable in each case.** Additionally, if the smoke is controlled, material assets are protected as well as the building's enclosures and structures, allowing to resume the business activity more quickly.

To ensure an optimum control of the smoke, **the smoke control system in the event of a fire must be activated, with equipment that guarantee it will operate** as designed for the anticipated temperature conditions and operating time, but it is also required that said system be designed following the existing standards or technical design specifications of renowned prestige as well as controlling the different equipment that will ensure the system operates properly.

To ensure the operation of the extract fans for smoke exhaust, **all of SODECA's solutions have a CE marking in accordance with European Standard EN 12101-3:2015. Smoke and heat control systems - Part 3: Specification for powered smoke and heat control ventilators (Fans).**



For a proper design of the smoke control system in the event of a fire, **SODECA has a Projects Department with specialised technicians that offer a personalised advice** from the start of the project, providing a complete technical study to include:

- Size calculations
- Equipment location drawings
- The system operating logic
- The specifications of all the equipment that make up the system

Including smoke extract fans, outside air supply fans, smoke control hatches and system control panels.

SODECA PROJECTS

SODECA has helped provide ventilation solutions for smoke extraction in international emblematic infrastructures.



CAR PARK VENTILATION
Hotel Sheraton Grand Tbilisi Palace, Georgia



CAR PARK VENTILATION
Madrid RIO shopping centre, Spain



SMOKE EXHAUST
Romsdal High School, Norway

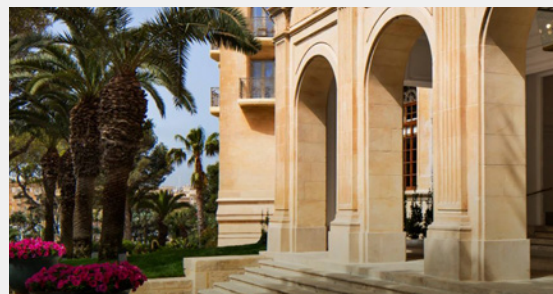

PRESSURISATION OF STAIRCASES
Phoenicia Hotel *****, Valletta



DEPRESSURISATION OF STAIRCASES
Penrose Dock, Ireland



SMOKE EXHAUST
Silo Inditex, Madrid



MEETING INTERNATIONAL STANDARDS

QUALITY MANAGEMENT SYSTEM

SODECA has implemented a Quality Management System that is certified in accordance with ISO 9001:2015 by Bureau Veritas, who has certified the company's ability to plan, execute and control the processes required for carrying out their work and keeping customers satisfied by delivering products manufactured using the highest quality standards.

A company committed to the reliability and warranty of their equipment installed at locations that are difficult to access and are fire safety system components.

For this reason, all critical points of the manufacturing process are inspected using a rigorous internal management control system:

- Certifications of **raw materials** (steel sheets)
- **Corrosion resistance** certification
- Review of **manufacturing processes**
- **Balancing of impellers**
- Checking **motor consumption**



Temperature certificates (EN 12101-3)

SODECA ventilation systems are designed with a dual purpose: daily ventilation (comfort) and emergency ventilation (in the event of fire). In the event of fire, the ventilation system controls the propagation of smoke and heat. For this reason, all the equipment is certified in accordance with EN 12101-3 by accredited and independent laboratories.



Performance tests (ISO 13500- ISO 5801)

The equipment is subjected to rigorous full-scale tests to check the performance of the fan (flow and pressure, thrust, vibrations, noise levels, etc.). These tests are carried out in accordance with international standards (ISO 13500- ISO 5801).





FAN TESTS AND FACTORY ACCEPTANCE TEST (FAT)

The performance criteria of fans are essential to ensure a proper application of the ventilation system inside the tunnel. Therefore, SODECA is strict in terms of achieving equipment performances and to achieve fan performance, the company follows a test methodology and test procedures as well as standards of renown prestige such as ISO 13350 and ISO 5801.

- Motor consumption
- Pressure
- Noise levels
- Flow
- Thrust
- Vibrations



**Factory
Acceptance
Test**

The client has the possibility of validating the performance and good operation of the equipment by carrying out a real test of the fan and supplied equipment at our installations.



RESEARCH AND DEVELOPMENT

Research and development are a continuous effort to continuously improve the equipment with the aim of achieving increased safety, durability and low maintenance with high levels of efficiency (ERP 2015). SODECA ventilation systems for tunnels are tailor-made in accordance with project requirements thanks to a great team of professionals with the know-how and high-performance technology to ensure the safety and quality of the products.

CUSTOMER SUPPORT SOLUTIONS



CONSULTING AND DESIGN

With the aim of offering a comprehensive service, SODECA offers support in consulting, design and personalised studies.



COMPUTATIONAL FLUID DYNAMICS CFD

We have the most advanced computational CFD simulation tools and the necessary experience in their use. This study makes it possible to check if the system operating parameters are complied with, such as smoke behaviour, temperature values, visibility and air speed or the concentration of gases.



Calculation software

QuickFan is the software used for making calculations and designing ventilation projects. Selecting the most suitable product for your ventilation installation is now easier than ever.

Make it easy with QuickFan!



3D Models

Through the projects module for QuickFan and by downloading the designs in CAD 3D or REVIT, you can design ventilation projects, make calculations and obtain full technical reports in just a few minutes.



BIM Format Fans

Saving time and resources when managing projects is possible thanks to the BIM system for more than 5,200 fan models. This format adds additional characteristics and technical information to the model and improves how the execution of a project is monitored.

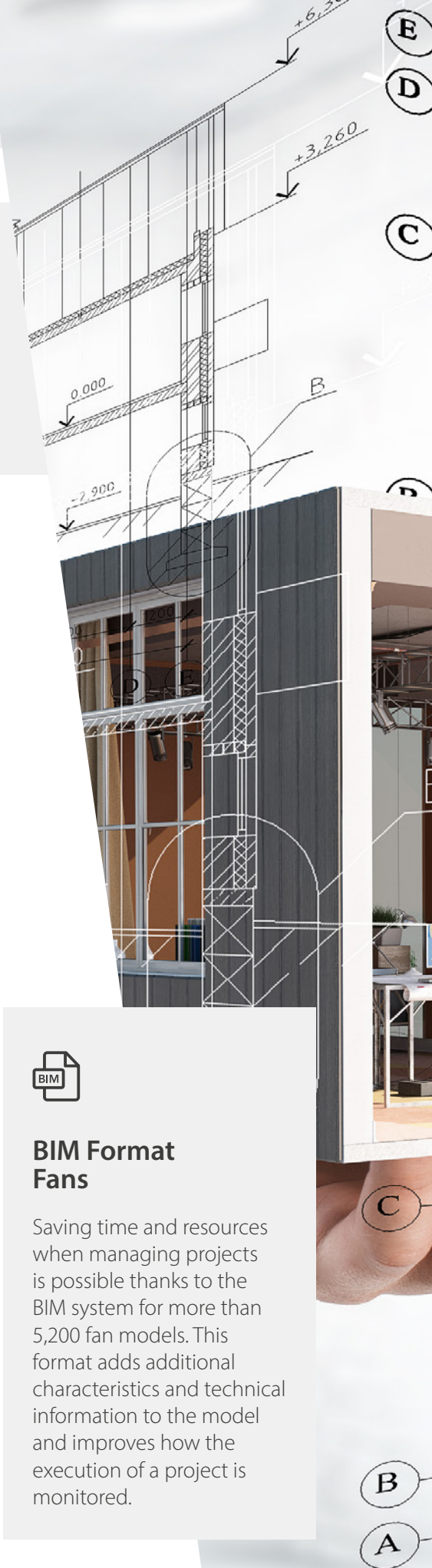

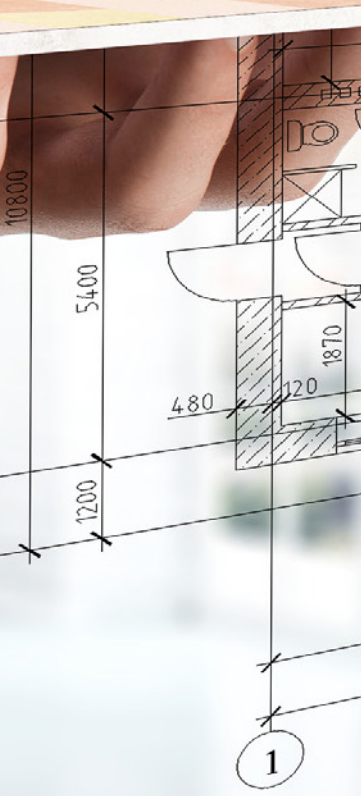
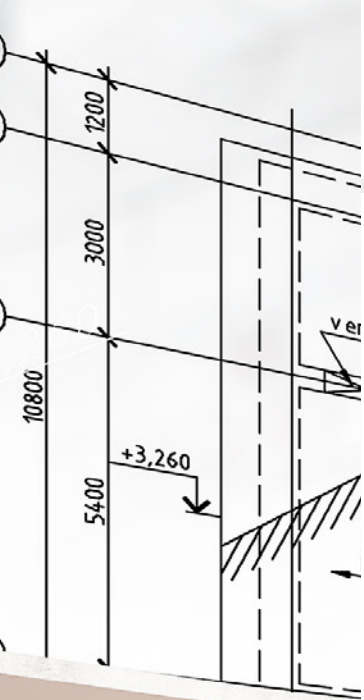

SYSTEMS FOR **SMOKE CONTROL IN THE EVENT OF FIRE**

- CAR PARKS
- INDUSTRIAL BUILDINGS AND PUBLICLY USED BUILDINGS
- COLD ROOMS
- EVACUATION ROUTES
- TUNNELS



CAR PARKS

It is essential for the ventilation system for car parks to be **reliable throughout the years to ensure it is safe for users.**

In car parks, ventilation may be natural or forced. In the latter, **fans must be installed to properly move the air** and maintain the

required conditions of safety and comfort under normal conditions as well as in the event of a fire.

FUNCTIONS OF VENTILATION FOR CAR PARKS

Car park ventilation systems are installed to carry out three functions:



Control smoke in the event of a fire, to help occupants evacuate as well as help fire-fighters extinguish the fire.



Maintain the **concentration of contaminating gases** emitted by vehicles under control.



Maintain the **concentration of explosive gases** generated by possible vehicle fuel leaks under control.

These three functions are integrated in a single system that is capable of providing a flow adapted to the needs at any given time with the aim of optimising the system's power consumption.

VENTILATION SYSTEMS IN CAR PARKS

MECHANICAL VENTILATION THROUGH DUCT SYSTEMS

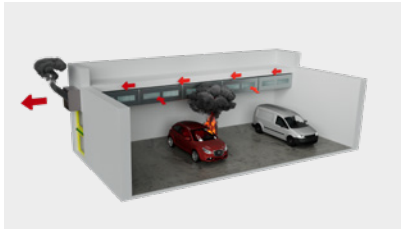

MECHANICAL VENTILATION ASSISTED BY IMPULSE VENTILATION



NATURAL VENTILATION ASSISTED BY IMPULSE VENTILATION



SOLUTIONS



IMMERSED

Installation of fan for immersed operation in fire risk zone



THT



CJTHT/PLUS



CJTHT/ATEX



THT/HATCH



CJBDT



CBDT



TCR



THT/WALL-F



CJS



CJMD



EXTERNAL

Installation of outdoor fans in the fire risk zone



TCR/R



CJTCR/R



TCMF



CJMP



CJTX-C



CJSX



CJSRX



CJLINE



JET FAN

Installation of jet fan in the fire risk zone



THT/IMP-O



THT/IMP-L



CI



INDUSTRIAL BUILDINGS AND PUBLICLY USED BUILDINGS

Smoke exhaust solutions limit the effects of heat and evacuate the smoke that is generated in the event of a fire.

These ventilation systems can **extract hot gases generated at the start of a fire and create smoke free areas below the layers of floating smoke**, helping the evacuation as well as the fire-fighting effort. Also, the appearance of secondary fires is prevented as well as control the temperature of the smoke to prevent the building from collapsing.

In order to produce all these advantages, **it is essential for smoke and heat extract fans to be reliable and operate perfectly** throughout their useful service life when required.

A smoke exhaust system must be projected and sized to achieve one or several of the following objectives:



**Protect the
evacuation
routes**



**Control of the
temperature of
gases**



**Help the
fire-fighting
operations**



**Protection
of building
structures**

The use of smoke exhaust systems in the event of a fire are designed for different types of buildings and applications, including: industrial buildings with one or several floors or with a mezzanine floor; palletised warehouses or with storage on shelves; shopping

centres with one or several floors; atriums and odd shaped buildings; entertainment and publicly used buildings; and also, non-compartmentalised spaces in buildings with more than one floor.

VENTILATION SYSTEMS IN INDUSTRIAL BUILDINGS AND PUBLICLY USED BUILDINGS

SMOKE EXHAUST IN BUILDINGS WITH A SINGLE FLOOR

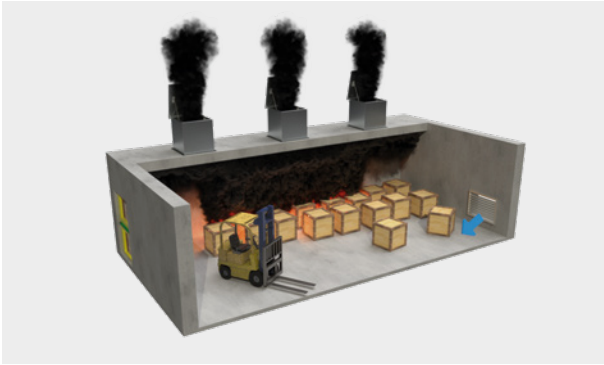

SMOKE EXHAUST IN MULTI-LEVEL BUILDINGS



SOLUTIONS

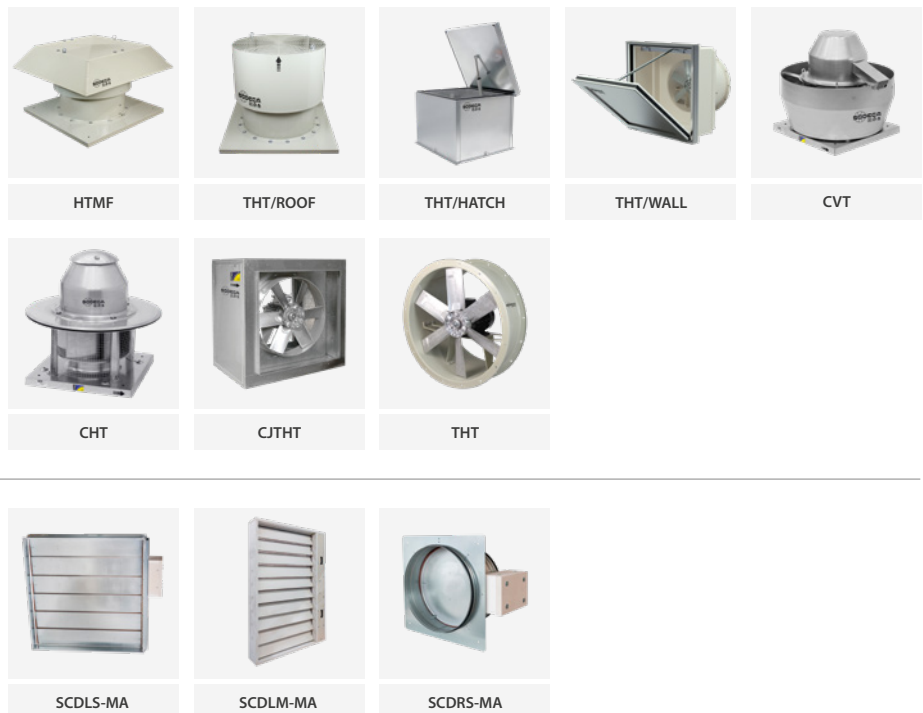



COLD ROOMS

The implementation of a smoke control system in the event of a fire in cold rooms have unique differences compared to traditionally installed smoke control systems in industrial buildings; specifically:

The **presence of a dual ceiling** (ceiling of the room and building roof) makes it difficult to exhaust the smoke produced during a fire to the exterior from inside the cold room.

The equipment installed on the casing of the cold room **requires thermal insulation features in order to prevent high energy losses.**

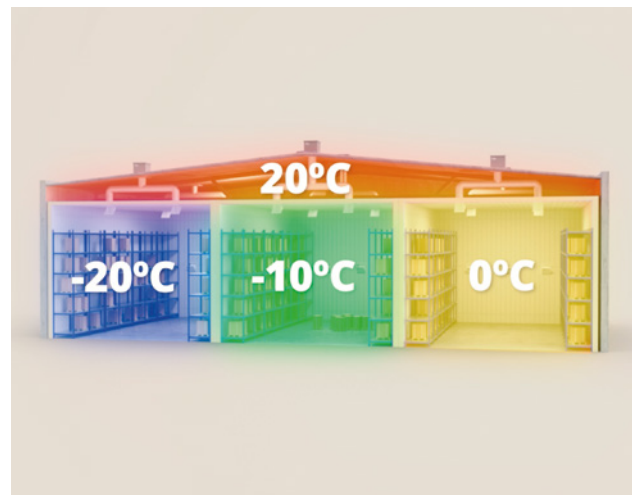

The presence of low temperatures inside the cold room may reduce the buoyancy of the smoke and make exhaustion difficult. For this reason, mechanical extraction systems are the option that offers the best performance guarantee.

SMOKE CONTROL SYSTEMS IN COLD ROOMS

DIRECT SMOKE EXHAUST FROM COLD ROOM



PLENUM SMOKE EXHAUST

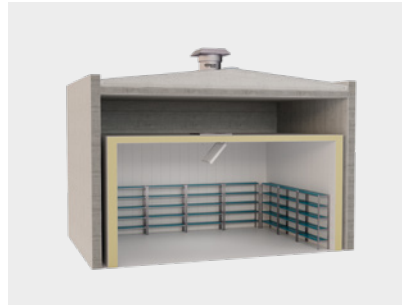

SMOKE EXHAUST LEAD FROM COLD ROOM

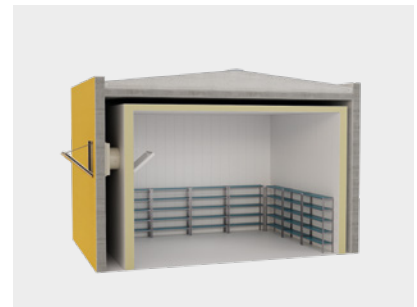
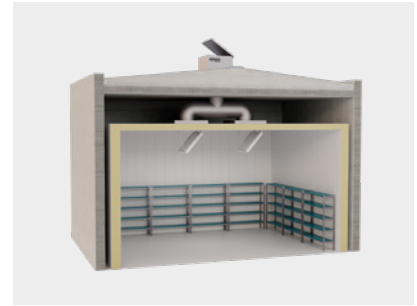

SOLUTIONS



THT/WALL



THT/WALL-F



THT/HATCH



HTMH



HTMV

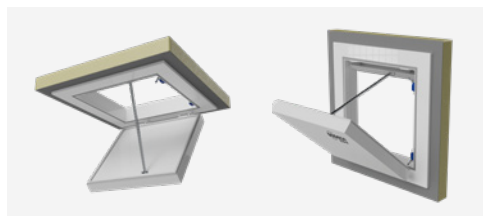

FRIDGE/FLAP

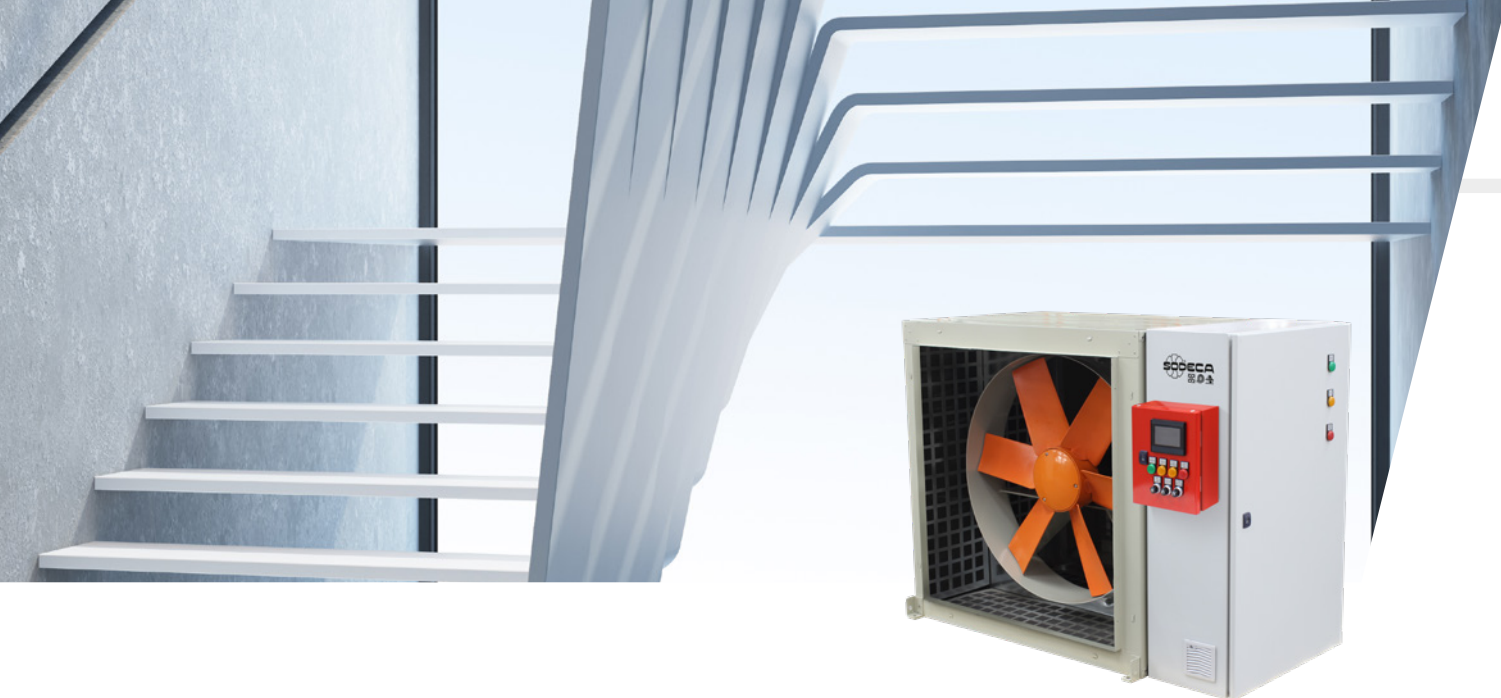

EVACUATION ROUTES

Pressurisation control systems protect evacuation routes in the event of fire, preventing the entry of smoke through air overpressure. If the doors are opened or in the event of air leaks, the system reacts by increasing the flow rate. This guarantees that the escape routes are always free of smoke in an emergency situation.

FUNCTIONS OF THE PRESSURISATION SYSTEM FOR EVACUATION ROUTES



Equipped with all the components required for proper operation in accordance with standard EN 12101-6 (fan, pressure sensor, hatch, speed controller, PLC, etc.)



Allows automatically controlling the flow when the door is open (speed criteria) and maintain a minimum differential pressure (50 Pa) in cases where the door is closed **in accordance with the requirements set out in European standard EN 12101-6.**



It is **connected to the Building Management System (BMS) or SCADA** and may get the status of all the equipment via a remote connection depending on the model. Also, **a remote communications panel may be added for use by the fire department or other users.**



The system incorporates an **activation in safe mode when a fire alarm signal is activated** and safe mode of operation when the doors are open due to an overpressure condition.



A motorised hatch and smoke detector may be used to manage air intake.



They are supplied integrated and ready for operation (Plug&Play system).



The **control panel** has status indicator lights and **an automatic or manual system power selector.**

EXTERNAL
AIR INLET

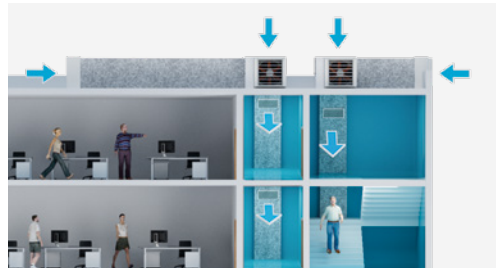

PRESSURISATION
AIR EXHAUST



PRESSURISATION
OF LOBBIES
JOINT
PRESSURISATION
OF ALL LOBBIES



PRESSURISATION
OF LOBBIES
INDIVIDUAL
PRESSURISATION
OF LOBBIES

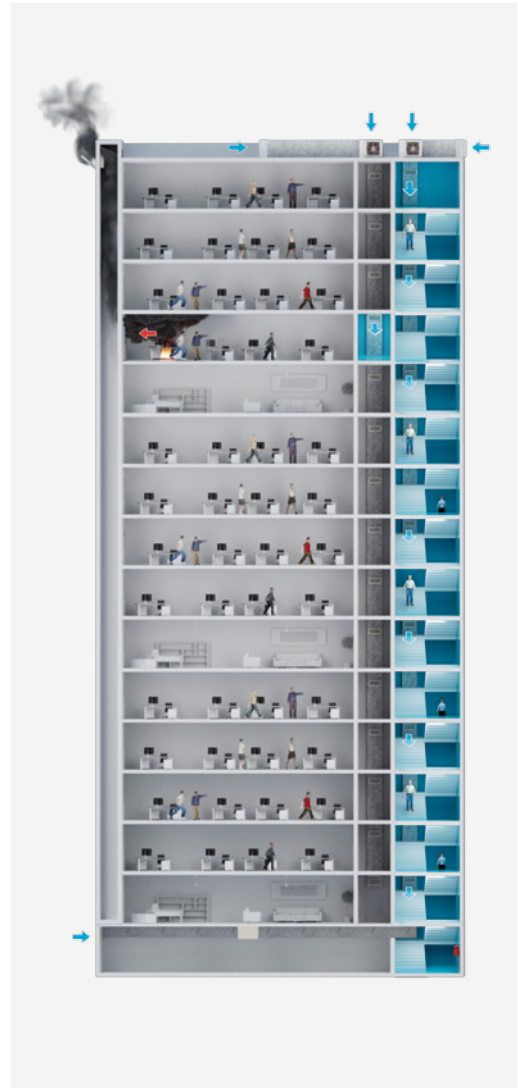

VERY TALL BUILDINGS

SOLUTIONS

FULL RANGE



HATCH PDS



KIT BOXPDS
KIT BOXPDS SMART



PDS LOBBY CONTROL

ADVANCED



KIT BOXSMART
KIT BOXSMART II

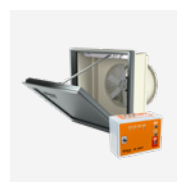

KIT BOXSMART FLAP



KIT BOXSMART EC

BASIC



KIT BOXPRES PLUS
KIT BOXPRES PLUS II



KIT SOBREPRESIÓN



PRESSKIT



TUNNELS

It is essential that reliable ventilation systems are used to provide safety for the user throughout the years.

Tunnel ventilation may be natural or forced and in the latter case, fans must be installed to generate the proper air movement to maintain safe conditions in comfort mode as well as in event of an emergency.

FUNCTIONS OF VENTILATION FOR TUNNELS

Ventilation system in **emergency mode** (in the event of fire):

Ventilation system in **comfort mode** (healthy air):



Provides a safe environment.



Maintains health conditions such as adequate temperature or humidity.



Exhaust of smoke and heat in the event of fire.



Supplies fresh and clean air from the outside.



Enables to maintain personnel evacuation routes clear and safe.



Extracting of air pollutants.



Safe and automated control system for activating emergency manoeuvres.

SMOKE CONTROL SYSTEMS **INSIDE TUNNELS**

Ventilation systems **may be configured based on different key elements** such as the type of tunnel, length, slope or traffic volume:

LONGITUDINAL VENTILATION

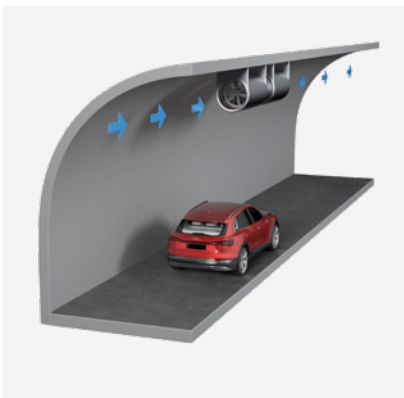

TRANSVERSE VENTILATION

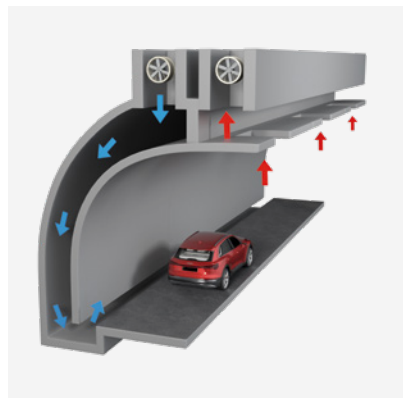

SEMI-TRANSVERSE VENTILATION



SOLUTIONS



THT/IMP-TM



THT-TM



THT/IMP



CI



HATCH



THT/WALL



THT/WALL-F

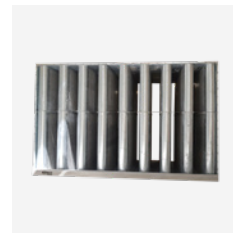

RECTANGULAR SILENCERS



CONTROL AND MANOEUVRE

SMOKE EXTRACT INSIDE FANS



27 THT
400°C/2h and 300°C/2h tubular axial extract fans with short casings



77 THT/CL
400°C/2h and 300°C/2h tubular axial extractor fans with long casing and external terminal boxes



86 THT/WALL
Dynamic wall mounted extractor fans with motorised hatch, for smoke exhaust in case of fires, 400°C/2h and 300°C/2h



94 THT/WALL-F
Dynamic wall mounted extractor fans with motorised hatch, for smoke exhaust in case of fires, 400°C/2h and 300°C/2h



99 THT/HATCH
400°C/2h and 300°C/2h rated dynamic discharge system with motorised opening function, fitted with roof mounted extractor, for smoke exhaust in the event of fire



107 CJTHT/PLUS
400°C/2h and 300°C/2h axial exhaust fan units with built-in acoustic attenuator



112 CJTHT
400°C/2h and 300°C/2h axial fans with acoustically insulated box



119 CJTHT/ATEX
400°C/2h and 300°C/2h axial exhaust units with ATEX certification



125 THT/IMP
400°C/2h and 300°C/2h long range unidirectional or reversible Jet fans



131 TUNEL JET FAN
Jet fans specially designed for tunnel ventilation. 400°C/2h and 300°C/2h certificates, depending on model



134 CI
Long-range 300°C/2h and 400°C/2h centrifugal induction Jet fans for use in fire risk zones with a low profile



137 HTMF
400°C/2h (F400) and 300°C/2h (F300) roof mounted multifunctional extract fans



145 THT/ROOF
400°C/2h and 300°C/2h roof mounted axial extract fans with vertical air outlets



149 CJBTD
Extract units with direct drive, to work inside the fire zone 400°C/2h and 300°C/2h



152 CBDT
Double inlet centrifugal fans, direct drive, to work inside the fire zone 400°C/2h and 300°C/2h



155 CJV/EW
Extract fans with automatic operation, vertical air outlet, EC Technology motor and constant pressure control for homes



158 TCR
400°C/2h and 300°C/2h centrifugal extractor fans with backward curved impeller



161 CJS
400°C/2h and 300°C/2h extractor fan units with interchangeable covers



164 CJMD
400°C/2h and 300°C/2h extractor fan units with linear inlet and outlet



SMOKE EXTRACT OUTSIDE FANS



168 TCR/R
400 °C/2h centrifugal extractor fans with backward curved impeller



172 TCR/R/EW
400 °C/2h centrifugal extractor fans with backward curved impeller fitted with electronically adjustable, high efficiency, asynchronous IE3 motors



177 CJTCR/R
400 °C/2h extractor fan units with backward curved impeller



182 CJTCR/R/EW
400 °C/2h extraction units fans with backward curved impeller fitted with electronically adjustable, high-efficiency, asynchronous IE3 motors



188 TCMP
400 °C/2h centrifugal extractor fans, with forward impeller



193 CJMP
400 °C/2h extractor fan units with forward impeller



199 CJTX-C
400°C/2h belt-driven double inlet extractor fan units



209 CJSX
400 °C/2h belt-driven single inlet extractor fan units



216 CJSRX
Extraction units 400 °C/2h to work outside the fire risk zone, driven by transmission with a backward curved impeller



223 CJLINE
400°C/2h air and smoke extract fan units with linear inlets and outlets



227 CJLINE/EC
Air extract units with linear inlet and outlet, equipped with EC Technology IE5 motor



232 CKD
F400 extractor fan units with a large door for ease of maintenance and 40 mm acoustic insulation slab



235 CKDR
F400 extractor fan units with a large door for ease of maintenance and 40 mm acoustic insulation slab



239 CKDR/EC
Extract units with large door and 40 mm acoustic insulation, equipped with EC Technology IE5 motor



244 CHT
400 °C/2h centrifugal roof fans with horizontal air outlet, aluminum hood



248 CHT/EC
Centrifugal roof fans with horizontal air outlet, with EC Technology IE5 motor



252 CVT
400 °C/2h centrifugal roof fans with vertical air outlet, aluminum hood



256 CVT/EC
Centrifugal roof fans with vertical air outlet, with EC Technology IE5 motor



FULL RANGE PRESSURISATION SYSTEMS

260 KIT BOXPDS
Pressurisation equipment for evacuation routes, designed according to the European standard EN 12101-6



263 KIT BOXPDS SMART
Pressurisation equipment for evacuation routes with advanced control, designed according to the European standard EN 12101-6



260 KIT BOXPDS II
Pressurisation equipment for evacuation routes with standby fan, designed according to the European standard EN 12101-6



263 KIT BOXPDS SMART II
Pressurisation equipment for evacuation routes with advanced control and standby fan, designed according to the European standard EN 12101-6



266 HATCH PDS
Equipment for pressurizing evacuation routes in the event of fire, designed according to the European standard EN 12101-6



ADVANCED PRESSURISATION SYSTEMS

269 KIT BOXSMART
Pressurisation system for stairs or evacuation routes. Maintains a differential pressure of 50 Pa in a single stage, designed according to the European standard EN 12101-6



269 KIT BOXSMART II
Pressurisation system for stairs or evacuation routes. Maintains a differential pressure of 50 Pa in a single stage, designed according to the European standard EN 12101-6



274 KIT BOXSMART EC
Pressurisation system for stairs or evacuation routes. Maintains a differential pressure of 50 Pa in a single stage, designed according to the European standard EN 12101-6



278 KIT BOXSMART FLAP
Pressurisation system for stairs or evacuation routes. Maintains a differential pressure of 50 Pa in a single stage, designed according to the European standard EN 12101-6



271 BOXSMART
Control panel for a fan



271 BOXSMART II
Control panel with standby fan



276 BOXSMART EC
Control panel for an EC motor fan



281 BOXSMART FLAP
Control panel with damper fan



BASIC PRESSURISATION SYSTEMS

283 KIT SOBREPRESIÓN
Pressurisation system for stairs or evacuation routes. Maintains a differential pressure of 50 Pa in a single stage, designed according to the European standard EN 12101-6



287 KIT BOXPRES PLUS
Pressurisation system for stairs or evacuation routes. Maintains a differential pressure of 50 Pa in a single stage, designed according to the European standard EN 12101-6



289 PRESSKIT
Pressurisation equipment for lobbies, compliant with DM 30/11/1983 and designed according to the European standard EN 12101-6



291 BOXPRES PLUS
Control panel for a fan



291 BOXPRES PLUS II
Control panel with standby fan



ACCESSORIES

294 BOXPARK
Control panels for car park ventilation systems with triple purpose: daily ventilation, CO concentration control and smoke extraction in case of fire



297 INT
On/Off safety switches in accordance with Standard UNE-EN 60204-1



297 INT/ATEX
ATEX stop-start switch according to directives 2014/34/UE and 2014/35/UE II 2D Ex tb IIIC T 85 °C Db II 3G Ex nR IIC T6 Gc IP66



297 IAT
Stop-start safety switches for 400 °C/2h to comply with the UNE-EN 60204-1 Standard



297 C2V
Switch for two speed motors



298 CABLE BOX
Electrical cable and connection box kit 400 °C/2h for external connections to the motor in fire fighting installations



298 RM
Electronic speed controllers for single-phase motors



299 VSD3/A-RFT - VSD1/A-RFM
Electronic variable speed drive for AC motors



300 CENTRAL CO
Monoxide detection control box, for ventilation in parking lots



300 AET
Star/delta starter and three-phase fan protection control panel, with stop and start buttons



301 P-400
Backdraught louvres, certified for 400 °C/2h



301 RT
Protection guard for inlet or outlet of long cased axial fans

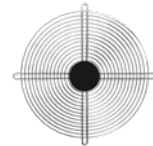

302 RPA
Protection guard for inlet of centrifugal fans



302 R/THT
Protection grille for the intake of THT series axial fans



303 BTUB
Coupling flange for axial fans



303 B
Coupling flange for centrifugal fans



304 BD
Double coupling flange for centrifugal fans



305 BAC
Double and elastic coupling flange for axial fans



305 BIC
Conversion flange from rectangular to circular for centrifugal fans



306 PS
Set of support feet for tubular fans



ACCESSORIES

306 MS
Support frame to facilitate mounting on site



307 PA
Adapter plate for mounting accessories, on roof extractors



307 BS
High base plate



307 BSS
High base plate with silencer



308 PT
Automatic closing shutters to work in vertical position. Version 400 certified 400 °C/2h



308 PT/H
Automatic closing shutters to work in horizontal position. Version 400 certified 400 °C/2h



309 VIS
Outlet hood with protection guard



310 ACE ACE/400
Elastic coupling to dampen vibrations



311 TEJ
Roof cover for outdoor



311 CM
Motor cover for outside work

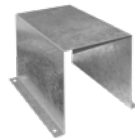

311 TAC
Circular coupling cap



312 S
Silencers to be coupled to the suction or discharge



316 SC
Silencers to be coupled to the suction or discharge



316 SI-PIR
Motion detector



316 SI-TEMP+HUMEDAD
Temperature and relative humidity sensor with display



317 SI-PRESIÓN
Pressure transmitter



317 SI-FUENTE DE ALIMENTACIÓN
24 V DC/AC power supply



317 SI-VENT
Wind sensor



317 SI-PRESOSTATO
Pressure sensor



318 PDS LOBBY CONTROL
Control panel and independent automatic regulation for lobby pressurisation systems



ACCESSORIES

320 DAMPER BOX
Motorised damper with built-in optical smoke detector for pressurization systems



320 DAMPER BOX SMART
Motorised damper with built-in optical smoke detector for pressurization systems



321 SCDLS-MA
Single compartment smoke control dampers with manual and automatic operation



322 SCDRS-MA
Single compartment circular smoke control dampers with manual or automatic operation



323 SCDLM-MA
Multi-compartment smoke control dampers with manual and automatic activation



THT

400°C/2h and 300°C/2h tubular axial extract fans with short casings



Tubular axial extract fans with short casing for immersed operation in fire risk zones.

Fan:

- Tubular casing in sheet steel.
- Variable angle impeller made of cast aluminium.
- Approved in accordance with standard EN 12101-3, with certifications no.: 0370-CPR-0305 (F400) and 0370-CPR-0973 (F300).
- Airflow direction from motor to impeller.

Motor:

- Class H motors for S1 continuous operation and S2 emergency use. With ball bearings, IP55 protection and 1 or 2 speeds, depending on model.
- Motors with IE3 efficiency for powers equal to or greater than 0.75 kW, except single-phase, 2-speed and 8-pole.
- Three-phase 230/400 V 50 Hz (up to 3 kW) and 400/690 V 50 Hz (powers greater than 3 kW).

- Maximum temperature of air to be carried: S1 -20 °C +40 °C continuous service, also suitable for warm climates with temperatures up to 50 °C. S2 operation, 300 °C/2h, 400 °C/2h.

Finish:

- Anti-corrosive finish in polyester resin, polymerised at 190 °C, after degreasing with phosphate-free nanotechnology treatment.

Available versions:

- THT/CL: tubular axial fans with long casing equipped with inspection hatch.

On request:

- Airflow direction from impeller to motor.
- 100% reversible impellers.

Order code

From size 40 to size 100

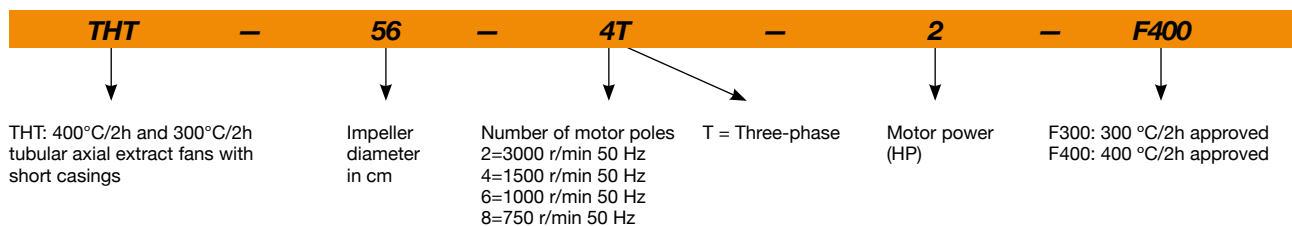

From size 125 to size 160

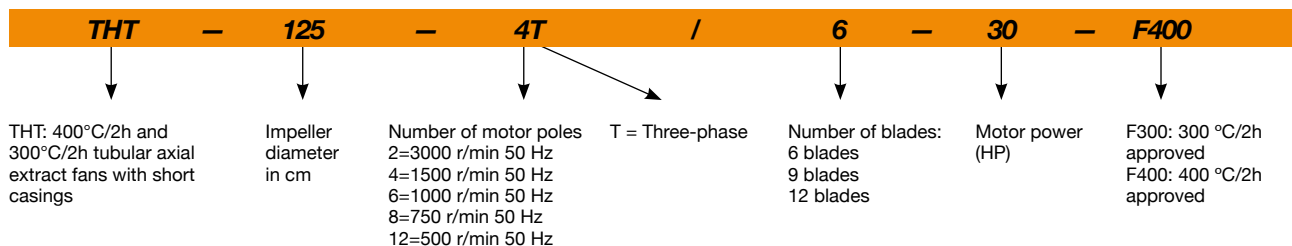

Technical characteristics

Model ¹	Speed (r/min)	Maximum admissible current (A)			Installed power (kW)	Blade tilt angle (°)	Maximum flow rate (m ³ /h)	Sound pressure level ² dB (A)	Approx. weight (Kg)
		230V	400V	690V				Inlet	
THT-40-2T-1.5 IE3	2880	4.02	2.23		1.10	20	7040	71	31
THT-40-2/4T-1.5	2900 / 1435		2.89 / 1.04		1.10 / 0.25	20	7040 / 3480	71 / 56	32
THT-40-4T-0.75	1420	2.84	1.64		0.55	32	4800	55	29
THT-40-6T-0.75	930	2.90	1.75		0.55	32	3150	46	34
THT-40-6/12T-0.75	940 / 455		1.98 / 0.84		0.55 / 0.09	32	3150 / 1520	46 / 31	38
THT-45-2T-2 IE3	2880	5.32	2.95		1.50	16	9400	71	34
THT-45-2/4T-2	2940 / 1460		4.33 / 1.36		1.50 / 0.37	16	9400 / 4670	71 / 56	34
THT-45-2T-3 IE3	2900	7.56	4.19		2.20	22	11330	71	36
THT-45-2T-4 IE3	2900	9.94	5.51		3.00	28	13075	72	46
THT-45-4T-0.75	1420	2.84	1.64		0.55	36	7450	58	30
THT-45-6T-0.75	930	2.90	1.75		0.55	30	4450	48	35
THT-45-6/12T-0.75	940 / 455		1.98 / 0.84		0.55 / 0.09	30	4450 / 2150	48 / 33	39
THT-50-2T-3 IE3	2870	7.56	4.19		2.20	12	11950	76	43
THT-50-4T-0.75	1420	2.84	1.64		0.55	22	8390	60	32
THT-50-6T-0.75	930	2.90	1.75		0.55	32	7000	52	36
THT-56-2T-5.5 IE3	2890		7.18	4.32	4.00	16	18800	78	60
THT-56-4T-1 IE3	1430	3.08	1.79		0.75	22	11250	63	40
THT-56-4T-1.5 IE3	1420	4.1	2.37		1.10	30	13600	63	40
THT-56-4/8T-1.5	1440 / 705		2.69 / 1.12		1.10 / 0.25	30	13600 / 6640	63 / 48	43
THT-56-4T-2 IE3	1425	5.89	3.38		1.50	36	15030	64	43
THT-56-6T-0.75	930	2.9	1.75		0.55	38	10140	54	39
THT-56-6/12T-0.75	940 / 455		2.35 / 1.15		0.60 / 0.15	38	10140 / 4890	54 / 39	43
THT-63-2T-12 IE3	2920		18.07	10.44	9.20	18	32300	83	143
THT-63-2T-20 IE3	2960		26.50	15.35	15.00	28	39950	82	170
THT-63-4T-1 IE3	1430	3.08	1.79		0.75	14	15190	67	43
THT-63-4T-1.5 IE3	1420	4.1	2.37		1.10	20	17800	66	45
THT-63-4/8T-1.5	1440 / 705		2.69 / 1.12		1.10 / 0.25	20	17800 / 8680	66 / 51	49
THT-63-4T-2 IE3	1425	5.89	3.38		1.50	24	19280	66	49
THT-63-4/8T-2	1415 / 715		3.40 / 1.65		1.50 / 0.30	24	19280 / 9740	66 / 52	60
THT-63-4T-3 IE3	1435	7.86	4.52		2.20	32	22150	68	54
THT-63-4/8T-3	1415 / 700		4.80 / 1.85		2.20 / 0.45	32	22150 / 10920	68 / 53	66
THT-63-4T-4 IE3	1430	11.01	6.33		3.00	38	24240	69	63
THT-63-4/8T-4	1420 / 710		6.45 / 2.28		3.00 / 0.60	38	24240 / 12070	69 / 54	77
THT-63-6T-0.75	930	2.9	1.75		0.55	28	13590	57	45
THT-63-6/12T-0.75	940 / 455		2.35 / 1.15		0.60 / 0.15	28	13590 / 6550	57 / 42	49
THT-63-6T-1 IE3	940	3.36	1.93		0.75	38	15890	58	48
THT-63-6/12T-1	935 / 455		3.75 / 2.76		0.80 / 0.20	38	15890 / 7700	58 / 43	55
THT-71-4T-1.5 IE3	1420	4.1	2.37		1.10	12	19480	71	52
THT-71-4/8T-1.5	1440 / 705		2.69 / 1.12		1.10 / 0.25	12	19480 / 9500	71 / 56	56
THT-71-4T-2 IE3	1425	5.89	3.38		1.50	14	20900	70	56
THT-71-4/8T-2	1415 / 715		3.40 / 1.65		1.50 / 0.30	14	20900 / 10560	70 / 56	67
THT-71-4T-3 IE3	1435	7.86	4.52		2.20	22	25100	70	61
THT-71-4/8T-3	1415 / 700		4.80 / 1.85		2.20 / 0.45	22	25100 / 12370	70 / 55	74
THT-71-4T-4 IE3	1430	11.01	6.33		3.00	28	27480	70	70
THT-71-4/8T-4	1420 / 710		6.45 / 2.28		3.00 / 0.60	28	27480 / 13680	70 / 55	83
THT-71-6T-0.75	930	2.9	1.75		0.55	20	16100	60	52
THT-71-6/12T-0.75	940 / 455		2.35 / 1.15		0.60 / 0.15	20	16100 / 7760	60 / 45	56
THT-71-6T-1 IE3	940	3.36	1.93		0.75	26	17300	60	55
THT-71-6/12T-1	935 / 455		3.75 / 2.76		0.80 / 0.20	26	17300 / 8380	60 / 45	62
THT-71-6T-1.5 IE3	945	4.73	2.72		1.10	34	19930	61	61
THT-71-6/12T-1.5	940 / 460		3.52 / 2.00		1.20 / 0.30	34	19930 / 9760	61 / 46	69
THT-80-4T-3 IE3	1435	7.86	4.52		2.20	12	25450	75	69
THT-80-4/8T-3	1415 / 700		4.80 / 1.85		2.20 / 0.45	12	25450 / 12550	75 / 60	82
THT-80-4T-4 IE3	1430	11.01	6.33		3.00	16	30250	74	78

Technical characteristics

Model ¹	Speed (r/min)	Maximum admissible current (A)			Installed power (kW)	Blade tilt angle (°)	Maximum flow rate (m ³ /h)	Sound pressure level ² dB (A) Inlet	Approx. weight (Kg)
		230V	400V	690V					
THT-80-4/8T-4	1420 / 710		6.45 / 2.28		3.00 / 0.60	16	30250 / 15060	74 / 59	92
THT-80-4T-5.5 IE3	1440		7.95	4.61	4.00	18	32750	73	85
THT-80-4/8T-5.5	1450 / 715		7.88 / 2.87		3.80 / 1.00	18	32750 / 16150	73 / 58	118
THT-80-6T-1.5 IE3	945	4.73	2.72		1.10	18	21450	63	69
THT-80-6/12T-1.5	940 / 460		3.52 / 2.00		1.20 / 0.30	18	21450 / 10500	63 / 48	77
THT-80-6T-2 IE3	945	6.25	3.62		1.50	26	25950	64	78
THT-80-6/12T-2	960 / 470		4.46 / 3.43		1.60 / 0.40	26	25950 / 12700	64 / 49	82
THT-80-6T-3 IE3	950	9.78	5.62		2.20	32	29930	65	84
THT-80-6/12T-3	940 / 475		5.62 / 3.32		2.20 / 0.55	32	29930 / 15120	65 / 51	91
THT-80-8T-0.75	700	3.48	2.00		0.55	20	17540	57	62
THT-80-8T-1	710	5.06	2.92		0.75	28	20650	58	69
THT-90-4T-4 IE3	1430	11.01	6.33		3.00	8	33580	79	93
THT-90-4/8T-4	1420 / 710		6.45 / 2.28		3.00 / 0.60	8	33580 / 16720	79 / 64	106
THT-90-4T-5.5 IE3	1440		7.95	4.61	4.00	12	38890	78	99
THT-90-4/8T-5.5	1450 / 715		7.88 / 2.87		3.80 / 1.00	12	38890 / 19170	78 / 63	132
THT-90-4T-7.5 IE3	1430		10.40	6.04	5.50	18	46140	77	126
THT-90-4/8T-7.5	1455 / 725		11.40 / 3.86		5.50 / 1.10	18	46140 / 22910	77 / 62	140
THT-90-4T-10 IE3	1460		14.20	8.17	7.50	22	50140	76	137
THT-90-4/8T-10	1455 / 725		15.10 / 5.16		7.50 / 1.50	22	50140 / 24900	76 / 61	140
THT-90-6T-2 IE3	945	6.25	3.62		1.50	16	28780	66	92
THT-90-6/12T-2	960 / 470		4.46 / 3.43		1.60 / 0.40	16	28780 / 14090	66 / 51	96
THT-90-6T-3 IE3	950	9.78	5.62		2.20	24	34000	66	99
THT-90-6/12T-3	940 / 475		5.62 / 3.32		2.20 / 0.55	24	34000 / 17180	66 / 52	105
THT-90-6T-4 IE3	945	12.8	6.36		3.00	30	38900	69	124
THT-90-6/12T-4	970 / 485		7.37 / 3.53		2.80 / 0.70	30	38900 / 19450	69 / 54	126
THT-90-8T-1	710	5.06	2.92		0.75	18	22900	60	84
THT-90-8T-2	700	7.32	4.21		1.50	30	29490	63	99
THT-90-8T-3	705	9.3	5.35		2.20	32	30850	64	116
THT-100-4T-7.5 IE3	1430		10.40	6.04	5.50	10	46850	82	131
THT-100-4/8T-7.5	1455 / 725		11.40 / 3.86		5.50 / 1.10	10	46850 / 23260	82 / 67	145
THT-100-4T-10 IE3	1460		14.20	8.17	7.50	16	57400	79	142
THT-100-4/8T-10	1455 / 725		15.10 / 5.16		7.50 / 1.50	14	54700 / 27160	80 / 65	145
THT-100-4T-15 IE3	1455		20.70	11.99	11.00	22	66300	79	195
THT-100-4/8T-15	1470 / 730		20.70 / 7.19		11.00 / 3.00	22	66300 / 32880	79 / 64	195
THT-100-4T-20 IE3	1460		27.80	16.03	15.00	28	76150	80	210
THT-100-4/8T-20	1470 / 725		31.72 / 11.75		15.00 / 3.80	28	76150 / 37560	80 / 65	210
THT-100-4T/9-15 IE3	1460		20.70	11.99	11.00	18	55340	80	204
THT-100-4T/9-20 IE3	1460		27.80	16.03	15.00	22	63260	80	219
THT-100-4T/9-25 IE3	1475		35.40	20.39	18.50	26	70625	80	249
THT-100-4T/9-30 IE3	1475		42.20	24.44	22.00	30	74845	82	266
THT-100-6T-3 IE3	950	9.78	5.62		2.20	16	37600	70	105
THT-100-6/12T-3	940 / 475		5.62 / 3.32		2.20 / 0.55	16	37600 / 18990	70 / 56	112
THT-100-6T-4 IE3	945	12.8	6.36		3.00	20	41150	69	130
THT-100-6/12T-4	970 / 485		7.37 / 3.53		2.80 / 0.70	20	41150 / 20580	69 / 54	131
THT-100-6T-5.5 IE3	970		8.37	4.82	4.00	26	47780	70	142
THT-100-6T/9-5.5 IE3	970		11.00	6.35	4.00	20	39020	70	145
THT-100-6T/9-7.5 IE3	970		12.30	7.07	5.50	26	46765	71	153
THT-100-6T/9-10 IE3	970		15.20	8.83	7.50	34	52255	74	193
THT-125-4T/6-20 IE3	1460		27.80	16.03	15.00	10	78600	87	290
THT-125-4/8T/6-20	1470 / 725		31.72 / 11.75		15.00 / 3.80	10	78600 / 38770	87 / 72	290
THT-125-4T/6-25 IE3	1465		35.40	20.39	18.50	14	92550	86	343
THT-125-4/8T/6-27	1470 / 730		39.70 / 14.10		20.00 / 5.00	16	98830 / 48910	85 / 70	357
THT-125-4T/6-30 IE3	1470		42.20	24.44	22.00	16	98830	85	357
THT-125-4/8T/6-37	1475 / 735		54.55 / 18.50		28.00 / 6.50	20	110890 / 55260	85 / 70	437

Technical characteristics

Model ¹	Speed (r/min)	Maximum admissible current (A)			Installed power (kW)	Blade tilt angle (°)	Maximum flow rate (m ³ /h)	Sound pressure level ² dB (A)	Approx. weight (Kg)
		230V	400V	690V				Inlet	
THT-125-4T/6-40 IE3	1475		53.30	31.02	30.00	22	117450	85	437
THT-125-4T/6-50 IE3	1480		66.80	38.70	37.00	26	131050	85	473
THT-125-4T/6-60 IE3	1475		80.90	46.90	45.00	28	135820	85	543
THT-125-4T/6-75 IE3	1480		98.60	57.20	55.00	34	152100	88	643
THT-125-4T/9-25 IE3	1465		35.40	20.39	18.50	10	79650	87	352
THT-125-4T/9-30 IE3	1470		42.20	24.44	22.00	12	88290	86	366
THT-125-4/8T/9-27	1470 / 730		39.70 / 14.10		20.00 / 5.00	12	88290 / 43690	86 / 71	366
THT-125-4/8T/9-37	1475 / 735		54.55 / 18.50		28.00 / 6.50	16	104040 / 51840	85 / 70	446
THT-125-4T/9-40 IE3	1475		53.30	31.02	30.00	16	104040	85	446
THT-125-4T/9-50 IE3	1480		66.80	38.70	37.00	20	118400	85	482
THT-125-4T/9-60 IE3	1475		80.90	46.90	45.00	24	134970	85	534
THT-125-4T/9-75 IE3	1480		98.60	57.20	55.00	28	146770	86	634
THT-125-4T/9-100 IE3	1480		128.00	74.22	75.00	34	158560	88	773
THT-125-4T/12-50 IE3	1480		66.80	38.70	37.00	18	101660	86	516
THT-125-4T/12-60 IE3	1475		80.90	46.90	45.00	20	109180	86	561
THT-125-4T/12-75 IE3	1480		98.60	57.20	55.00	26	131240	86	661
THT-125-4T/12-100 IE3	1480		128.00	74.22	75.00	32	154100	88	791
THT-125-6T/6-5.5 IE3	970		8.37	4.82	4.00	10	51500	77	218
THT-125-6T/6-7.5 IE3	970		12.30	7.07	5.50	14	60640	75	225
THT-125-6/12T/6-7.5	970 / 480		14.50 / 5.17		5.50 / 1.00	14	60640 / 30010	75 / 60	239
THT-125-6T/6-10 IE3	960		15.20	8.83	7.50	20	72650	74	255
THT-125-6/12T/6-10	970 / 490		13.60 / 5.69		7.20 / 1.80	20	72650 / 36510	74 / 60	275
THT-125-6T/6-15 IE3	955		22.50	13.07	11.00	26	85850	74	285
THT-125-6/12T/6-15	970 / 485		23.10 / 8.41		11.00 / 3.00	26	85850 / 42710	74 / 59	290
THT-125-6T/6-20 IE3	950		29.00	16.78	15.00	30	92850	76	343
THT-125-6/12T/6-24	970 / 480		41.60 / 13.21		17.60 / 2.85	34	99650 / 49320	78 / 63	437
THT-125-6T/9-10 IE3	960		15.20	8.83	7.50	14	63490	77	264
THT-125-6/12T/9-10	970 / 490		13.60 / 5.69		7.20 / 1.80	14	63490 / 31910	77 / 63	284
THT-125-6T/9-15 IE3	955		22.50	13.07	11.00	20	77550	75	294
THT-125-6/12T/9-15	970 / 485		23.10 / 8.41		11.00 / 3.00	20	77550 / 38580	75 / 60	299
THT-125-6T/9-20 IE3	950		29.00	16.78	15.00	26	92950	75	352
THT-125-6/12T/9-24	970 / 480		41.60 / 13.21		17.60 / 2.85	30	98500 / 48750	76 / 61	446
THT-125-6T/9-25 IE3	975		36.10	20.77	18.50	32	101450	77	372
THT-125-6T/9-30 IE3	975		42.30	24.35	22.00	36	106525	80	382
THT-125-6T/12-10 IE3	970		15.20	8.83	7.50	12	49630	79	328
THT-125-6T/12-15 IE3	970		22.50	13.07	11.00	18	67315	77	338
THT-125-6T/12-20 IE3	970		29.00	16.78	15.00	24	81840	76	396
THT-125-6T/12-25 IE3	975		36.10	20.77	18.50	30	96765	77	406
THT-125-6T/12-30 IE3	975		42.30	24.35	22.00	32	102040	78	416
THT-125-6T/12-40 IE3	985		56.00	32.50	30.00	34	106355	79	571
THT-140-6T/6-7.5 IE3	970		12.30	7.07	5.50	8	62800	83	260
THT-140-6T/6-15 IE3	955		22.50	13.07	11.00	16	86640	78	327
THT-140-6T/6-20 IE3	950		29.00	16.78	15.00	22	102950	77	396
THT-140-6T/6-25 IE3	975		36.10	20.77	18.50	24	108750	77	448
THT-140-6T/6-30 IE3	975		42.30	24.35	22.00	28	119050	77	457
THT-140-6T/9-15 IE3	955		22.50	13.07	11.00	12	77400	82	336
THT-140-6T/9-20 IE3	950		29.00	16.78	15.00	16	91200	81	405
THT-140-6T/9-25 IE3	975		36.10	20.77	18.50	20	103800	80	458
THT-140-6T/9-30 IE3	975		42.30	24.35	22.00	22	111000	79	467
THT-140-6T/9-40 IE3	985		56.00	32.50	30.00	28	128800	79	611
THT-140-6T/9-50 IE3	980		67.20	39.00	37.00	32	135750	80	696
THT-140-6T/9-60 IE3	985		84.40	48.90	45.00	38	145610	82	931
THT-140-6T/12-30 IE3	975		42.30	24.35	22.00	20	101570	81	492
THT-140-6T/12-40 IE3	985		56.00	32.50	30.00	28	128800	80	647

Technical characteristics

Model ¹	Speed (r/min)	Maximum admissible current (A)			Installed power (kW)	Blade tilt angle (°)	Maximum flow rate (m ³ /h)	Sound pressure level ² dB (A)		Approx. weight (Kg)
		230V	400V	690V				Inlet		
THT-140-6T/12-50 IE3	985		67.20	39.00	37.00	32	143360	81	730	
THT-140-6T/12-60 IE3	985		84.40	48.90	45.00	36	156705	82	940	
THT-140-6T/12-75 IE3	985		103.00	59.70	55.00	38	162890	83	965	
THT-160-6T/6-20 IE3	950		29.00	16.78	15.00	12	111990	85	463	
THT-160-6T/6-25 IE3	975		36.10	20.77	18.50	14	121100	84	515	
THT-160-6T/6-30 IE3	975		42.30	24.35	22.00	16	129330	83	524	
THT-160-6T/6-40 IE3	985		56.00	32.50	30.00	22	153700	82	669	
THT-160-6T/6-50 IE3	980		67.20	39.00	37.00	26	170800	81	757	
THT-160-6T/6-60 IE3	985		84.40	48.90	45.00	30	185460	82	984	
THT-160-6T/6-75 IE3	985		103.00	59.70	55.00	34	199030	83	1029	
THT-160-6T/9-25 IE3	975		36.10	20.77	18.50	10	104250	90	525	
THT-160-6T/9-30 IE3	975		42.30	24.35	22.00	14	126800	88	534	
THT-160-6T/9-40 IE3	985		56.00	32.50	30.00	18	145500	86	679	
THT-160-6T/9-50 IE3	980		67.20	39.00	37.00	20	154940	85	768	
THT-160-6T/9-60 IE3	985		84.40	48.90	45.00	24	176750	85	968	
THT-160-6T/9-75 IE3	985		103.00	59.70	55.00	28	192290	84	1013	
THT-160-6T/12-60 IE3	985		84.40	48.90	45.00	20	151615	86	1002	
THT-160-6T/12-75 IE3	985		103.00	59.70	55.00	26	182250	85	1047	

¹ The 40, 45, 50 and 56-2T models only in F300 version.
² The noise level values are pressures in dB(A) measured at a distance of 3 metres in a free field.



Erp. (Energy Related Products)

Information on Directive 2009/125/EC can be downloaded from the SODECA website or the QuickFan selector programme.

Acoustic characteristics

Sound power spectrum Lw(A) in dB(A) per Hz frequency band
 Values measured at inlet with maximum flow rate

	63	125	250	500	1000	2000	4000	8000		63	125	250	500	1000	2000	4000	8000
40-2-1.5	47	63	75	83	88	86	82	75	63-8-2 (2V)	39	51	60	66	66	66	60	52
40-4-1.5 (2V)	32	48	60	68	73	71	67	60	63-4-3	56	68	77	83	83	83	77	69
40-4-0.75	37	53	63	70	71	68	67	68	63-8-3 (2V)	41	53	62	68	68	68	62	54
40-6-0.75	28	44	54	61	62	59	58	59	63-4-4	57	69	78	84	84	84	78	70
40-12-0.75 (2V)	12	28	38	45	46	43	42	43	63-8-4 (2V)	42	54	63	69	69	69	63	55
45-2-2	47	60	74	86	87	86	82	74	63-6-0.75	48	58	68	72	73	71	64	56
45-4-2 (2V)	32	45	59	71	72	71	67	59	63-12-0.75 (2V)	32	42	52	56	57	55	48	40
45-2-3	47	64	74	81	88	86	83	75	63-6-1	49	59	69	73	74	72	65	57
45-2-4	52	69	78	84	88	88	83	75	63-12-1 (2V)	32	42	52	56	57	55	48	40
45-4-0.75	47	59	67	73	73	73	68	60	71-4-1.5	57	73	80	86	86	86	82	74
45-6-0.75	37	49	57	63	63	63	58	50	71-8-1.5 (2V)	41	57	64	70	70	70	66	58
45-12-0.75 (2V)	21	33	41	47	47	47	42	34	71-4-2	56	72	79	85	85	85	81	73
50-2-3	58	74	84	91	92	89	88	89	71-8-2 (2V)	41	57	64	70	70	70	66	58
50-4-0.75	49	61	69	75	75	75	70	62	71-4-3	56	72	79	85	85	85	81	73
50-6-0.75	41	53	61	67	67	67	62	54	71-8-3 (2V)	41	57	64	70	70	70	66	58
56-2-5.5	53	66	84	92	94	93	88	81	71-4-4	63	75	79	85	85	86	83	75
56-4-1	51	63	72	78	78	78	72	64	71-8-4 (2V)	48	60	64	70	70	71	68	60
56-4-1.5	51	63	72	78	78	78	72	64	71-6-0.75	46	53	73	76	76	71	63	55
56-8-1.5 (2V)	35	47	56	62	62	62	56	48	71-12-0.75 (2V)	30	37	57	60	60	55	47	39
56-4-2	52	64	73	79	79	79	73	65	71-6-1	46	64	73	76	76	71	64	55
56-6-0.75	45	55	65	69	70	68	61	53	71-12-1 (2V)	29	47	56	59	59	54	47	38
56-12-0.75 (2V)	29	39	49	53	54	52	45	37	71-6-1.5	47	65	74	77	77	72	65	56
63-2-12	64	81	91	97	98	97	95	97	71-12-1.5 (2V)	32	50	59	62	62	57	50	41
63-2-20	63	80	90	96	97	96	94	96	80-4-3	55	71	84	91	91	88	82	74
63-4-1	48	64	76	82	84	81	74	66	80-8-3 (2V)	40	56	69	76	76	73	67	59
63-4-1.5	47	63	75	81	83	80	73	65	80-4-4	54	70	83	90	90	87	81	73
63-8-1.5 (2V)	31	47	59	65	67	64	57	49	80-8-4 (2V)	39	55	68	75	75	72	66	58
63-4-2	54	66	75	81	81	81	75	67	80-4-5.5	53	69	82	89	89	86	80	72

Acoustic characteristics

Sound power spectrum Lw(A) in dB(A) per Hz frequency band
Values measured at inlet with maximum flow rate

	63	125	250	500	1000	2000	4000	8000		63	125	250	500	1000	2000	4000	8000
80-8-5.5 (2V)	38	54	67	74	74	71	65	57	125-4/9-50	65	79	92	100	102	99	94	86
80-6-1.5	53	68	75	78	79	76	70	62	125-4/9-60	73	86	95	99	101	100	96	89
80-12-1.5 (2V)	38	53	60	63	64	61	55	47	125-4/9-75	74	87	96	100	102	101	97	90
80-6-2	59	69	75	79	80	78	73	65	125-4/9-100	76	89	98	102	104	103	99	92
80-12-2 (2V)	43	53	59	63	64	62	57	49	125-4/12-50	66	80	93	101	103	100	95	87
80-6-3	60	70	76	80	81	79	74	66	125-4/12-60	66	80	93	101	103	100	95	87
80-12-3 (2V)	45	55	61	65	66	64	59	51	125-4/12-75	74	87	96	100	102	101	97	90
80-8-0.75	46	59	67	72	74	71	64	53	125-4/12-100	76	89	98	102	104	103	99	92
80-8-1	47	60	68	73	75	72	65	54	125-6/6-5.5	64	79	89	92	93	90	85	77
90-4-4	61	77	88	94	95	93	88	80	125-6/6-7.5	62	77	87	90	91	88	83	75
90-8-4 (2V)	46	62	73	79	80	78	73	65	125-12/6-7.5 (2V)	47	62	72	75	76	73	68	60
90-4-5.5	60	76	87	93	94	92	87	79	125-6/6-10	61	76	86	89	90	87	82	74
90-8-5.5 (2V)	45	61	72	78	79	77	72	64	125-12/6-10 (2V)	46	61	71	74	75	72	67	59
90-4-7.5	59	75	86	92	93	91	86	78	125-6/6-15	61	76	86	89	90	87	82	74
90-8-7.5 (2V)	44	60	71	77	78	76	71	63	125-12/6-15 (2V)	45	60	70	73	74	71	66	58
90-4-10	58	74	85	91	92	90	85	77	125-6/6-20	63	78	88	91	92	89	84	76
90-8-10 (2V)	43	59	70	76	77	75	70	62	125-6/6-24	65	80	90	93	94	91	86	78
90-6-2	52	67	78	82	82	78	71	63	125-12/6-24 (2V)	50	65	75	78	79	76	71	63
90-12-2 (2V)	36	51	62	66	66	62	55	47	125-6/9-10	61	76	87	93	94	88	84	77
90-6-3	52	67	78	82	82	78	71	63	125-12/9-10 (2V)	46	61	72	78	79	73	69	62
90-12-3 (2V)	37	52	63	67	67	63	56	48	125-6/9-15	59	74	85	91	92	86	82	75
90-6-4	60	70	80	85	85	82	76	68	125-12/9-15 (2V)	43	58	69	75	76	70	66	59
90-12-4 (2V)	45	55	65	70	70	67	61	53	125-6/9-20	59	74	85	91	92	86	82	75
90-8-1	42	63	70	75	78	74	67	56	125-6/9-24	60	75	86	92	93	87	83	76
90-8-2	51	66	73	78	81	77	70	59	125-12/9-24 (2V)	45	60	71	77	78	72	68	61
90-8-3	53	67	74	79	82	78	71	60	125-6/9-25	61	76	87	93	94	88	84	77
100-4-7.5	67	83	90	97	98	96	92	84	125-6/9-30	64	79	90	96	97	91	87	80
100-8-7.5 (2V)	52	68	75	82	83	81	77	69	125-6/12-10	63	78	89	95	96	90	86	79
100-4-10	65	81	88	95	96	94	90	82	125-6/12-15	61	76	87	93	94	88	84	77
100-8-10 (2V)	50	66	73	80	81	79	75	67	125-6/12-20	60	75	86	92	93	87	83	76
100-4-15	71	83	87	93	94	94	91	83	125-6/12-25	61	76	87	93	94	88	84	77
100-8-15 (2V)	56	68	72	78	79	79	76	68	125-6/12-30	62	77	88	94	95	89	85	78
100-4-20	72	84	88	94	95	95	92	84	125-6/12-40	63	78	89	95	96	90	86	79
100-8-20 (2V)	57	69	73	79	80	80	77	69	140-6/6-7.5	63	79	91	97	98	96	94	96
100-4/9-15	65	81	88	95	96	94	90	82	140-6/6-15	58	74	86	92	93	91	89	91
100-4/9-20	72	84	88	94	95	95	92	84	140-6/6-20	57	73	85	91	92	90	88	90
100-4/9-25	72	84	88	94	95	95	92	84	140-6/6-25	56	72	84	92	94	89	87	89
100-4/9-30	74	86	90	96	97	97	94	86	140-6/6-30	57	73	85	91	92	90	88	90
100-6-3	57	72	82	85	86	83	75	67	140-6/9-15	64	77	89	97	99	95	91	83
100-12-3 (2V)	42	57	67	70	71	68	60	52	140-6/9-20	63	76	88	96	98	94	90	82
100-6-4	56	71	81	84	85	82	74	66	140-6/9-25	62	75	87	95	97	93	89	81
100-12-4 (2V)	41	56	66	69	70	67	59	51	140-6/9-30	61	74	86	94	96	92	88	80
100-6-5.5	57	72	82	85	86	83	75	67	140-6/9-40	61	74	86	94	96	92	88	80
100-6/9-5.5	57	72	82	85	86	83	75	67	140-6/9-50	52	65	76	85	91	94	98	92
100-6/9-7.5	58	73	83	86	87	84	76	68	140-6/9-60	54	67	78	87	93	96	100	94
100-6/9-10	61	76	86	89	90	87	79	71	140-6/12-30	63	76	88	96	98	94	90	82
125-4/6-20	69	85	96	103	104	102	95	87	140-6/12-40	62	75	87	95	97	93	89	81
125-8/6-20 (2V)	54	70	81	88	89	87	80	72	140-6/12-50	53	66	77	86	92	95	99	93
125-4/6-25	68	84	95	102	103	101	94	86	140-6/12-60	54	67	78	87	93	96	100	94
125-4/6-27	67	83	94	101	102	100	93	85	140-6/12-75	55	68	79	88	94	97	101	95
125-8/6-27 (2V)	52	68	79	86	87	85	78	70	160-6/6-20	67	83	92	99	100	98	97	97
125-4/6-30	67	83	94	101	102	100	93	85	160-6/6-25	66	82	91	98	99	97	96	96
125-4/6-37	67	83	94	101	102	100	93	85	160-6/6-30	66	82	91	98	99	96	96	96
125-8/6-37 (2V)	52	68	79	86	87	85	78	70	160-6/6-40	64	80	89	96	97	95	94	94
125-4/6-40	67	83	94	101	102	100	93	85	160-6/6-50	64	80	89	96	97	94	94	94
125-4/6-50	67	83	94	101	102	100	93	85	160-6/6-60	64	80	89	96	97	95	94	94
125-4/6-60	67	83	94	101	102	100	93	85	160-6/6-75	56	69	78	86	92	97	100	100
125-4/6-75	70	86	97	104	105	103	96	88	160-6/9-25	75	88	97	105	107	105	100	91
125-4/9-25	67	81	94	102	104	101	96	88	160-6/9-30	73	86	95	103	105	103	98	89
125-4/9-30	66	80	93	101	103	100	95	87	160-6/9-40	71	84	93	101	103	101	96	87
125-4/9-27	51	65	78	86	88	85	80	72	160-6/9-50	70	83	92	100	102	100	95	86
125-8/9-27 (2V)	66	80	93	101	103	100	95	87	160-6/9-60	70	83	92	100	102	100	95	86
125-4/9-37	65	79	92	100	102	99	94	86	160-6/9-75	59	72	80	87	88	100	103	96
125-8/9-37 (2V)	50	64	77	85	87	84	79	71	160-6/12-60	71	84	93	101	103	101	96	87
125-4/9-40	65	79	92	100	102	99	94	86	160-6/12-75	60	73	81	88	89	101	104	97

Dimensions mm

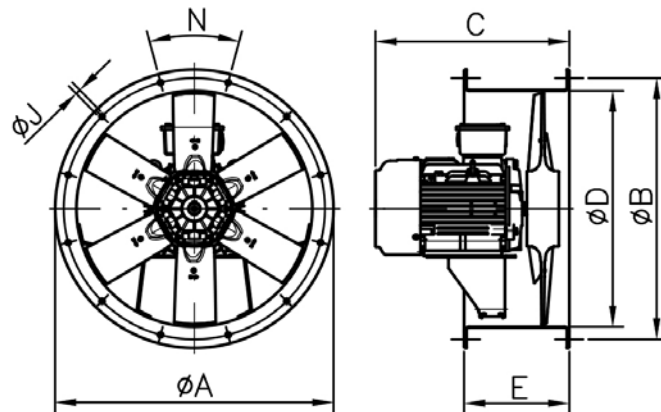

Motor size	ØA	ØB	C	ØD	E	ØJ	N
THT-40 80	490	450	356	410	250	12	8x45°
THT-40 90S	490	450	398.5	410	250	12	8x45°
THT-40 90L	490	450	429	410	250	12	8x45°
THT-45 80	540	500	356	460	250	12	8x45°
THT-45 90S	540	500	398.5	460	250	12	8x45°
THT-45 90L	540	500	429	460	250	12	8x45°
THT-45 100	540	500	435	460	250	12	8x45°
THT-50 80	600	560	356	514	250	12	12x30°
THT-50 90S	600	560	398.5	514	250	12	12x30°
THT-50 90L	600	560	429	514	250	12	12x30°
THT-50 100	600	560	435	514	250	12	12x30°
THT-50 112	600	560	456.5	514	250	12	12x30°
THT-56 80	660	620	356	560	250	12	12x30°
THT-56 90S	660	620	398.5	560	250	12	12x30°
THT-56 90L	660	620	429	560	250	12	12x30°
THT-56 100	660	620	432	560	250	12	12x30°
THT-56 112	660	620	460.5	560	250	12	12x30°
THT-56 132S	660	620	495	560	250	12	12x30°
THT-56 132M	660	620	533	560	250	12	12x30°
THT-63 80	730	690	356	640	250	12	12x30°
THT-63 90S	730	690	398.5	640	250	12	12x30°
THT-63 90L	730	690	429	640	250	12	12x30°
THT-63 100	730	690	432	640	250	12	12x30°
THT-63 112	730	690	455.5	640	250	12	12x30°
THT-63 132S	730	690	523	640	250	12	12x30°
THT-63 132M	730	690	561	640	250	12	12x30°
THT-63 160M	730	690	660	640	350	12	12x30°
THT-63 160L	730	690	704	640	350	12	12x30°
THT-71 80	810	770	363	710	300	12	16x22°30'
THT-71 90S	810	770	398.5	710	300	12	16x22°30'
THT-71 90L	810	770	429	710	300	12	16x22°30'
THT-71 100	810	770	434	710	300	12	16x22°30'
THT-71 112	810	770	452.5	710	300	12	16x22°30'
THT-80 90L	900	860	426.5	800	300	12	16x22°30'
THT-80 100	900	860	462	800	300	12	16x22°30'
THT-80 112	900	860	480.5	800	300	12	16x22°30'
THT-80 132S	900	860	516	800	300	12	16x22°30'

Motor size	ØA	ØB	C	ØD	E	ØJ	N
THT-90 100	1015	970	472	900	350	15	16x22°30'
THT-90 112	1015	970	500.5	900	350	15	16x22°30'
THT-90 132S	1015	970	526	900	350	15	16x22°30'
THT-90 132M	1015	970	564	900	350	15	16x22°30'
THT-100 112	1115	1070	490.5	1000	450	15	16x22°30'
THT-100 132S	1115	1070	526	1000	450	15	16x22°30'
THT-100 132M	1115	1070	564	1000	450	15	16x22°30'
THT-100 160M	1115	1070	658	1000	450	15	16x22°30'
THT-100 160L	1115	1070	702	1000	450	15	16x22°30'
THT-100 180M	1115	1070	711	1000	450	15	16x22°30'
THT-100 180L	1115	1070	749	1000	450	15	16x22°30'
THT-125 132M	1365	1320	603.5	1250	500	15	20x18°
THT-125 160M	1365	1320	660	1250	500	15	20x18°
THT-125 160L	1365	1320	704	1250	500	15	20x18°
THT-125 180M	1365	1320	715	1250	500	15	20x18°
THT-125 180L	1365	1320	753	1250	500	15	20x18°
THT-125 200	1365	1320	824.5	1250	500	15	20x18°
THT-125 225	1365	1320	881	1250	500	15	20x18°
THT-125 250	1365	1320	1025.5	1250	700	15	20x18°
THT-125 280	1365	1320	1129.6	1250	900	15	20x18°
THT-140 132S	1515	1470	537	1400	400	15	20x18°
THT-140 132M	1515	1470	575	1400	400	15	20x18°
THT-140 160L	1515	1470	704	1400	450	15	20x18°
THT-140 180L	1515	1470	762	1400	550	15	20x18°
THT-140 200	1515	1470	824.5	1400	550	15	20x18°
THT-140 225	1515	1470	881	1400	550	15	20x18°
THT-140 250	1515	1470	1025.5	1400	600	15	20x18°
THT-140 280	1515	1470	1110	1400	700	15	20x18°
THT-160 132S	1735	1680	537	1600	400	19	24x15°
THT-160 132M	1735	1680	575	1600	400	19	24x15°
THT-160 160L	1735	1680	704	1600	450	19	24x15°
THT-160 180L	1735	1680	762	1600	550	19	24x15°
THT-160 200	1735	1680	824.5	1600	550	19	24x15°
THT-160 225	1735	1680	881	1600	550	19	24x15°
THT-160 250	1735	1680	1025.5	1600	600	19	24x15°
THT-160 280	1735	1680	1110	1600	700	19	24x15°

Motor build sizes depending on power (1 speed)

	HP											
	0.75	1	1.5	2	3	4	5.5	7.5	10	12	15	20
2T (3000 r/min)	80	80	80	90S	90L	100LB	112M	132S	132S	132MA	160M	160M
4T (1500 r/min)	80	90S	90S	90L	100LA	100LB	112M	132S	132M	-	160ML	160L
6T (1000 r/min)	90S	90S	90L	100L	112M	132S	132MA	132MB	160M	-	160L	180ML
8T (750 r/min)	90L	100LA	100L	112M	132S	132M	160MA	160M	160L	-	180L	200MLA

	HP							
	22	25	30	40	50	60	75	100
2T (3000 r/min)	160L	180M	180L	200L	225S/M	225S/M	250S/M	280S/M
4T (1500 r/min)	-	180M	180L	200L	225S/M	225S/M	250S/M	280S/M
6T (1000 r/min)	-	200MLA	200MLB	225SMB	250S/M	280S/M	280S/M	-
8T (750 r/min)	-	225SMA	225SMB	250SMA	280S/M	280S/M	-	-

Motor build sizes depending on power (2 speeds)

	HP											
	0.75	1	1.5	2	3	4	5.5	6	7.5	8	9	10
2/4 (3000/1500 r/min)	-	-	90S	90S	90L	100L	-	112M	-	-	132M	-
4/8 (1500/750 r/min)	-	-	90S	100L	100LA	100LC	132S	-	132S	132S	132ML	132M
6/12 (1000/500 r/min)	90L	100L	100LB	112M	112M	132MC	160M	160M	160LB	160LB	-	160LB

	HP									
	12	15	18	20	22	24	27	37	38	40
2/4 (3000/1500 r/min)	160MA	-	160M	-	160L	-	-	-	-	-
4/8 (1500/750 r/min)	-	160M	-	160L	180M	180M	180L	200MLA	200L	225S/M
6/12 (1000/500 r/min)	-	200MLC	160L	200M	-	250SMB	225S/M	-	225S/M	-

Accessories



Configuration with BOXPARK



Control panels for car park ventilation systems with triple purpose: daily ventilation, CO concentration control and smoke extraction in case of fire

Control panels in metal enclosure with all the necessary elements for the management and control of fans in car park ventilation systems, whether they are based on duct networks or impulse fans, for the control of CO concentration levels and smoke extraction in case of fire. Customised panels for all power ratings and number of fans according to project requirements.

More information see BOXPARK series.

Installation examples with BOXPARK

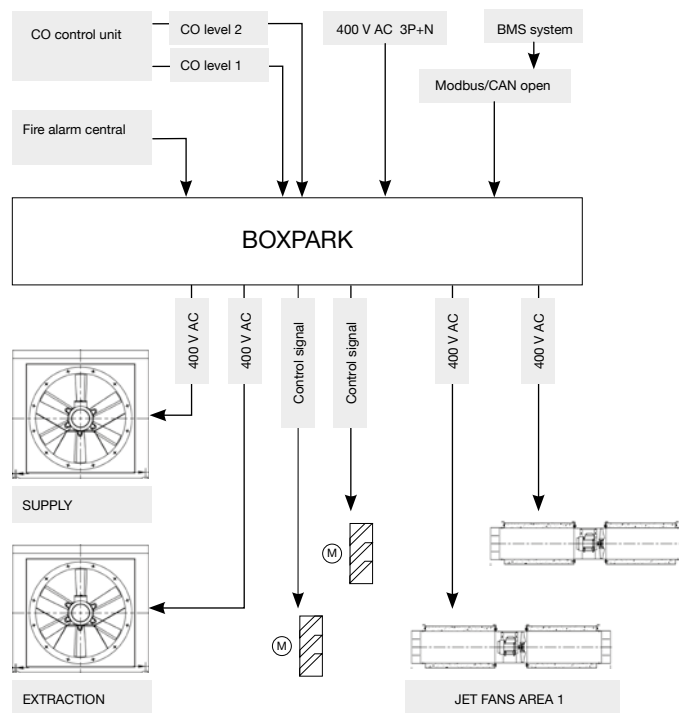

EXAMPLE OF SELECTION

Characteristic curves

Q= Flow rate in m³/h, m³/s and cfm

Pe= Static pressure in mm H₂O, Pa and inwg

Impeller diameter in cm: 71

Number of motor poles: 6

Number of blades: 6

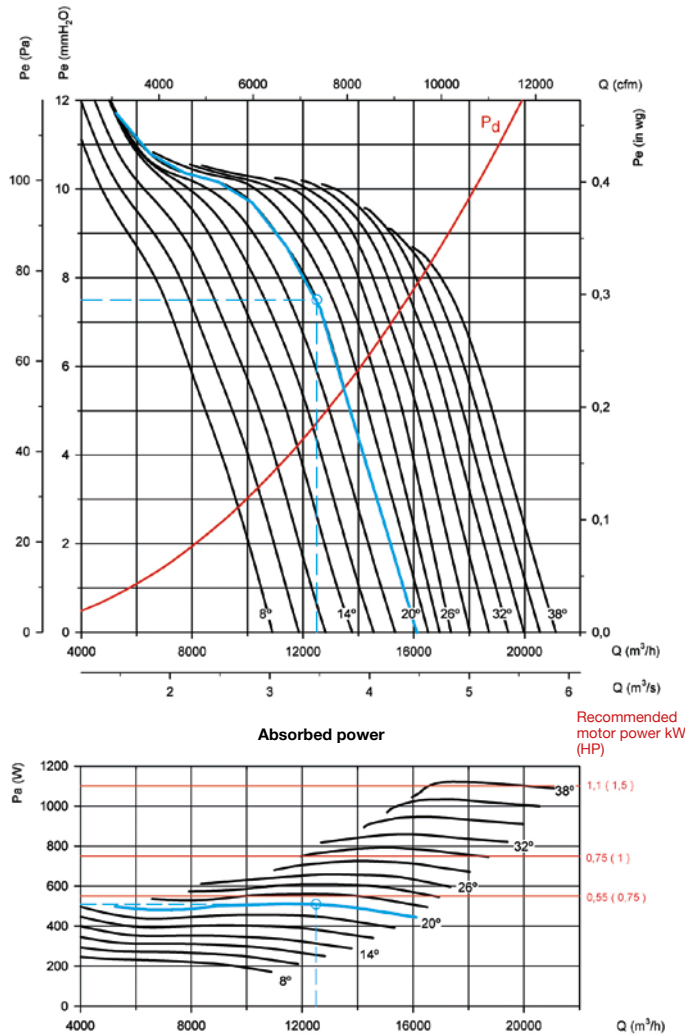

Initial data

Working point:

- Flow rate: 12,500 m³/h
- Loss of load: 7.5 mmH₂O

Steps for the selection of equipment

On the pressure graph:

- Mark the working point, defined by the airflow (12,500 m³/h) and the loss of load (7.5 mmH₂O).
- Select the curve of the equipment which is closest above the working point. In our case, a curve with a blade angle of 20° is obtained.

On the power graph:

- Mark the working point, defined by the airflow (12,500 m³/h) and the selected blade angle (20°).
- Read the absorbed power on the power axis on the left. Pa= 510 W at the working point.
- Look for the straight red line which is closest to the working point above. On the right-hand side of the graph, the value of the installed motor power is obtained. In our case, this is 0.55 kW or 0.75 HP.

EXAMPLE OF ORDER CODE

THT	-	71	-	6T	-	0.75	-	F400
Name of series: THT		Impeller diameter in cm		Number of motor poles 2=3000 r/min 50 Hz 4=1500 r/min 50 Hz 6=1000 r/min 50 Hz 8=750 r/min 50 Hz 12=500 r/min 50 Hz	T = Three-phase	Motor power (HP)		F300: 300 °C/2h approved F400: 400 °C/2h approved

Characteristic curves

Q= Flow rate in m³/h, m³/s and cfm

Pe= Static pressure in mm H₂O, Pa and inwg

Impeller diameter in cm: 40

Number of motor poles: 2

Number of blades: 6

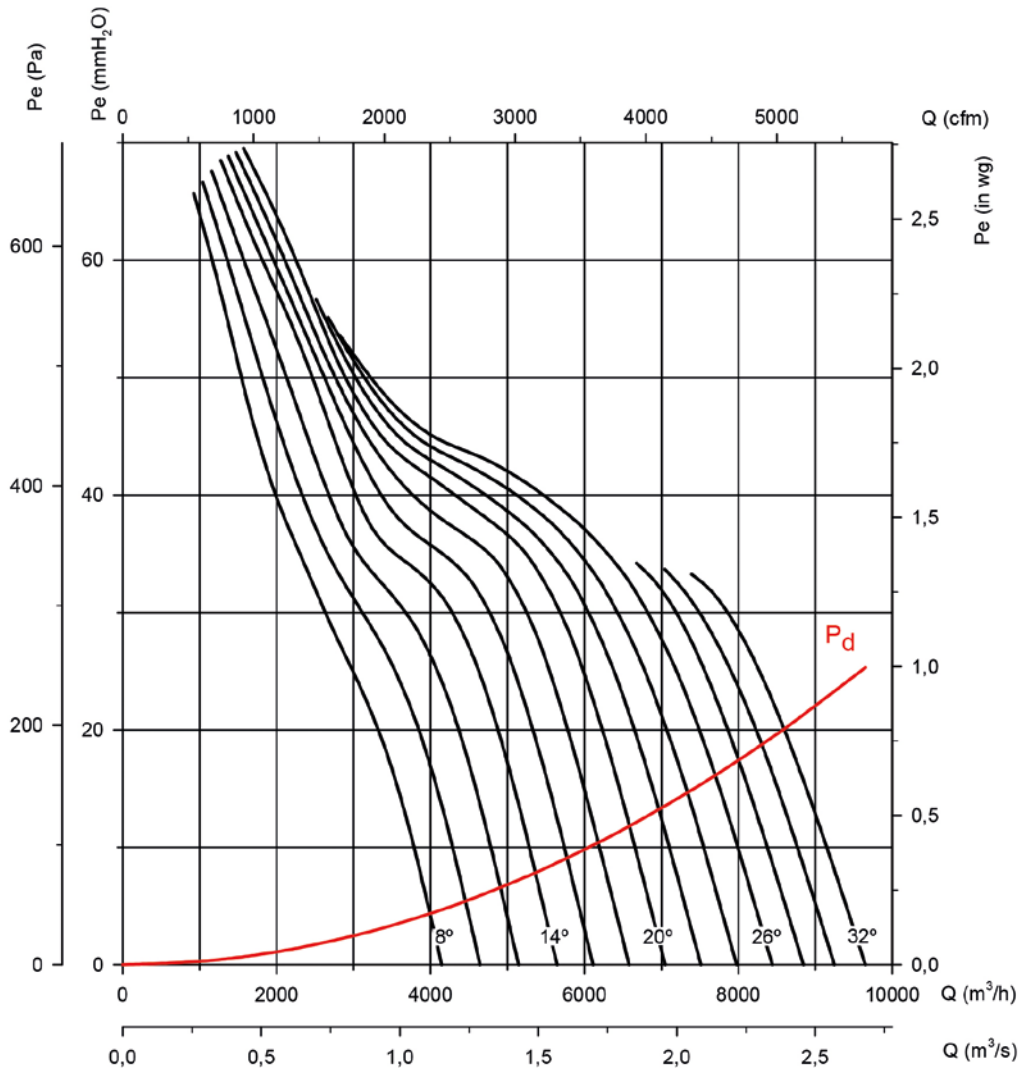

Absorbed power

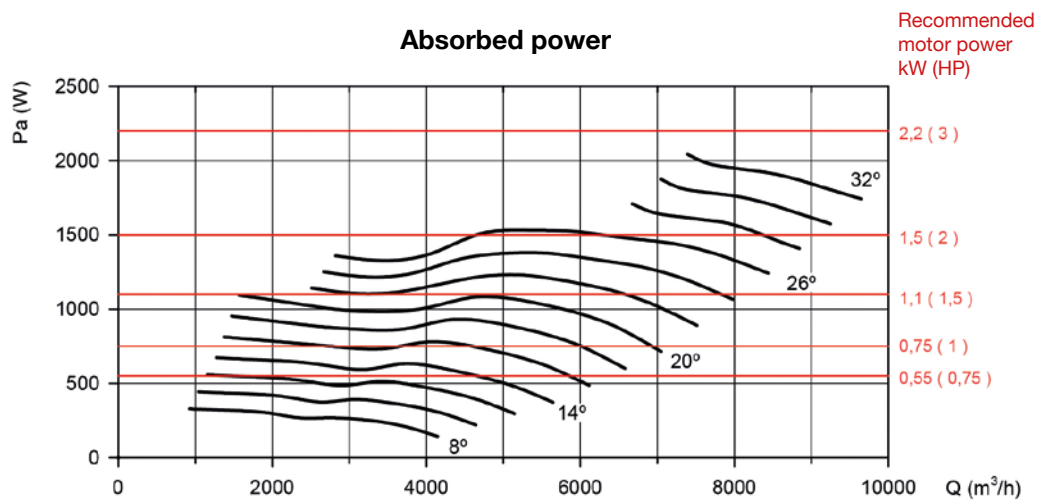

Characteristic curves

Q= Flow rate in m³/h, m³/s and cfm

Pe= Static pressure in mm H₂O, Pa and inwg

Impeller diameter in cm: 40

Number of motor poles: 4

Number of blades: 6

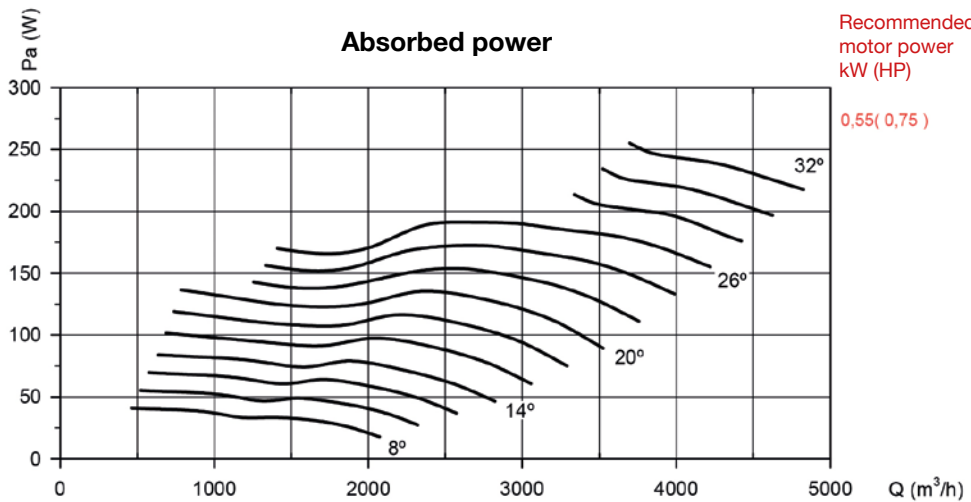
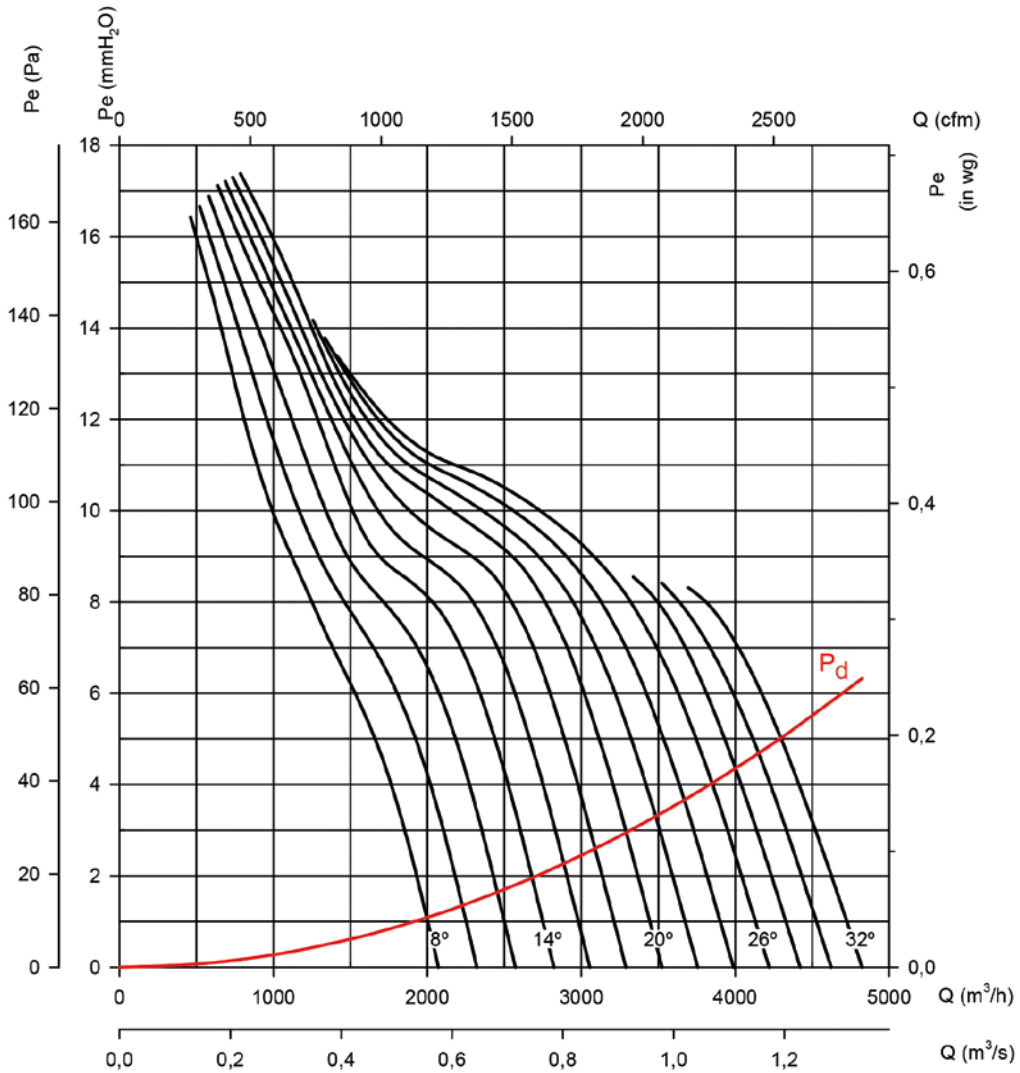

Characteristic curves

Q= Flow rate in m³/h, m³/s and cfm

Pe= Static pressure in mm H₂O, Pa and inwg

Impeller diameter in cm: 40

Number of motor poles: 6

Number of blades: 6

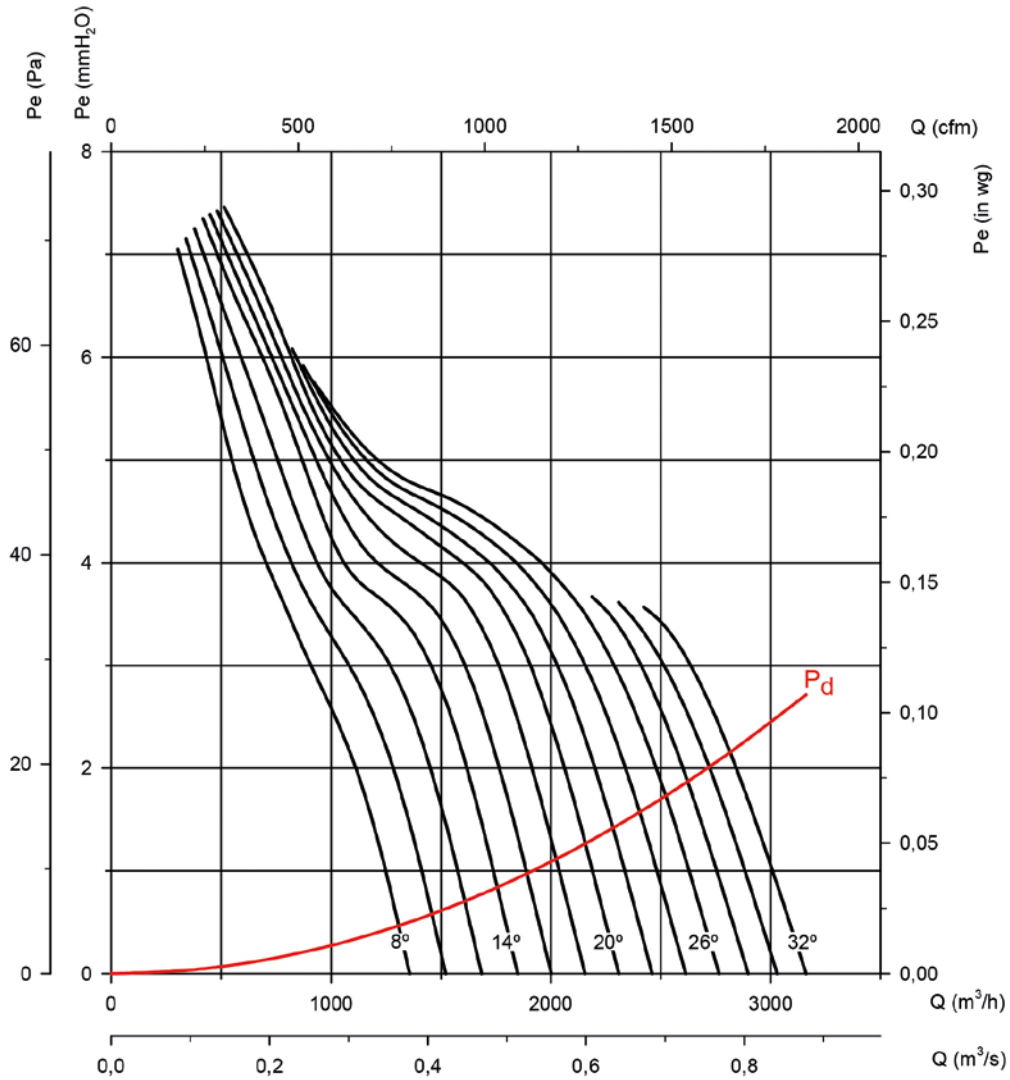

Absorbed power

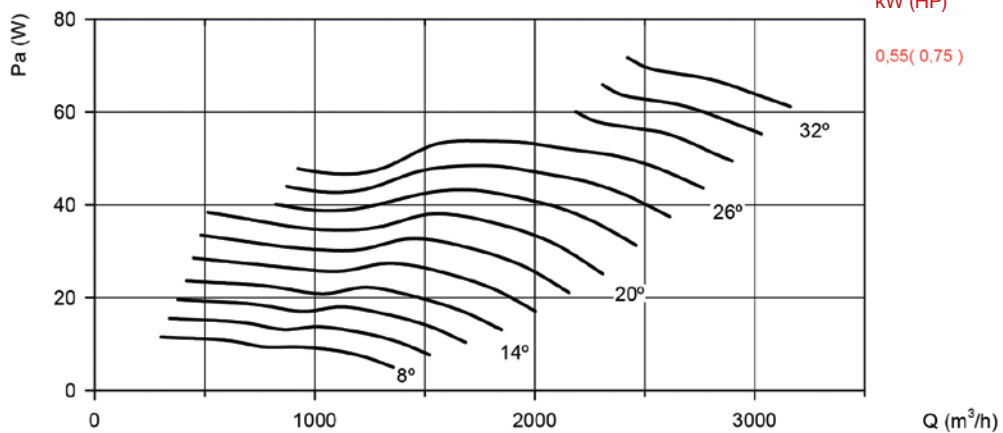

Characteristic curves

Q= Flow rate in m³/h, m³/s and cfm Pe= Static pressure in mm H₂O, Pa and inwg

Impeller diameter in cm: 45

Number of motor poles: 2

Number of blades: 6

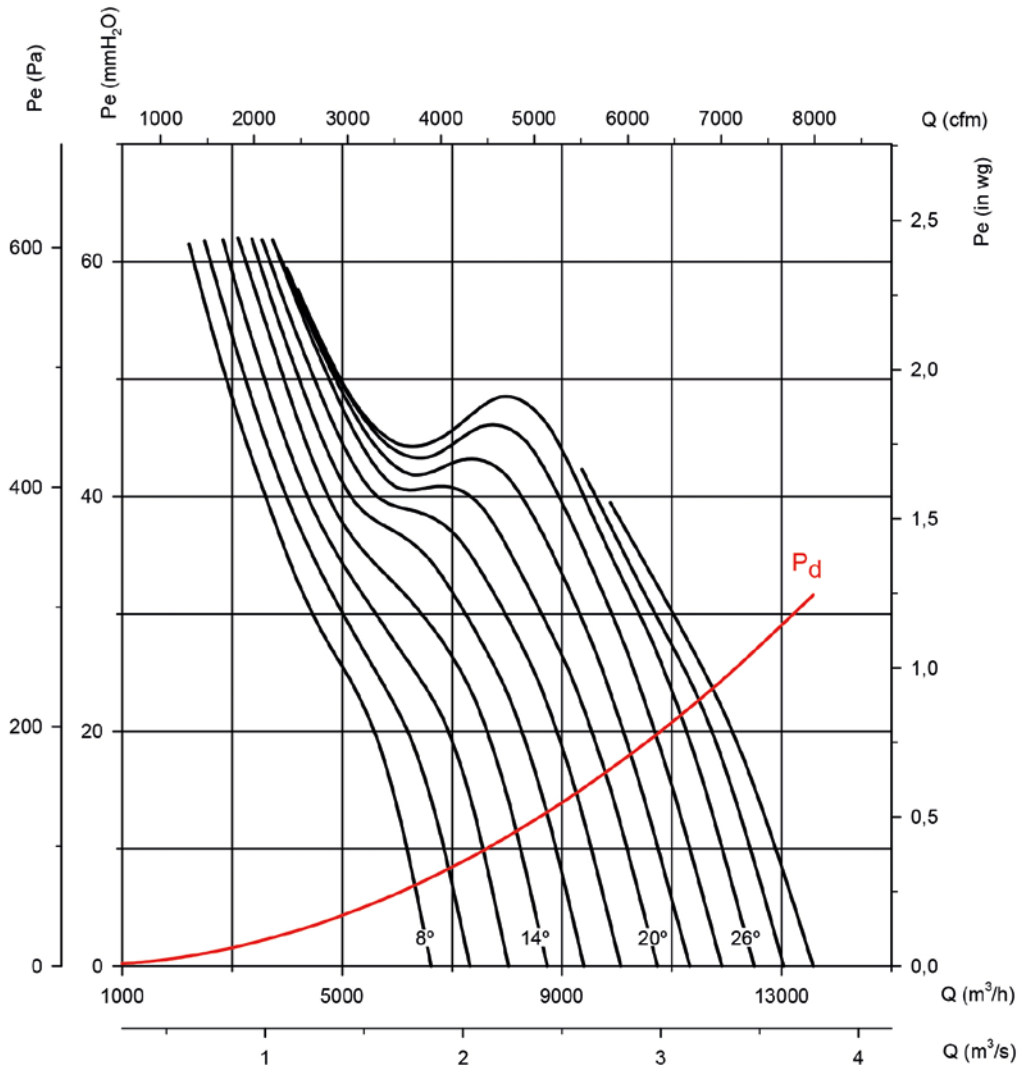

Absorbed power

Recommended motor power kW (HP)

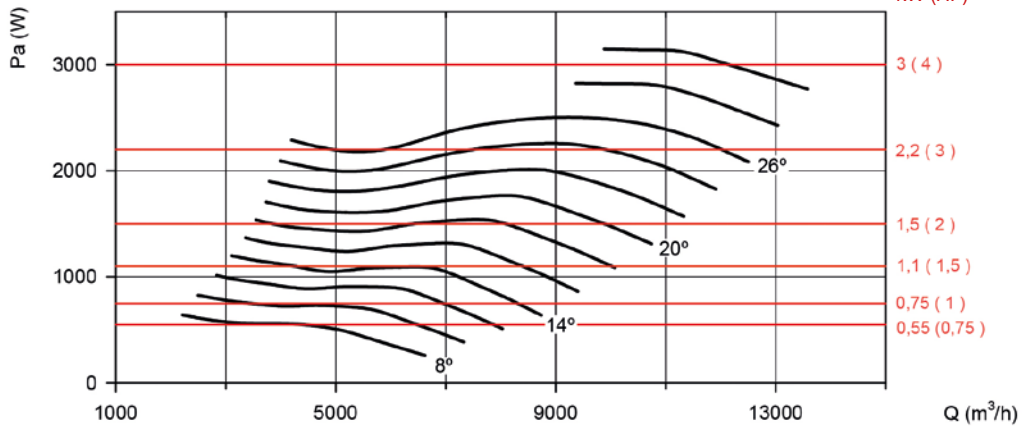

Characteristic curves

Q= Flow rate in m³/h, m³/s and cfm

Pe= Static pressure in mm H₂O, Pa and inwg

Impeller diameter in cm: 45

Number of motor poles: 4

Number of blades: 6

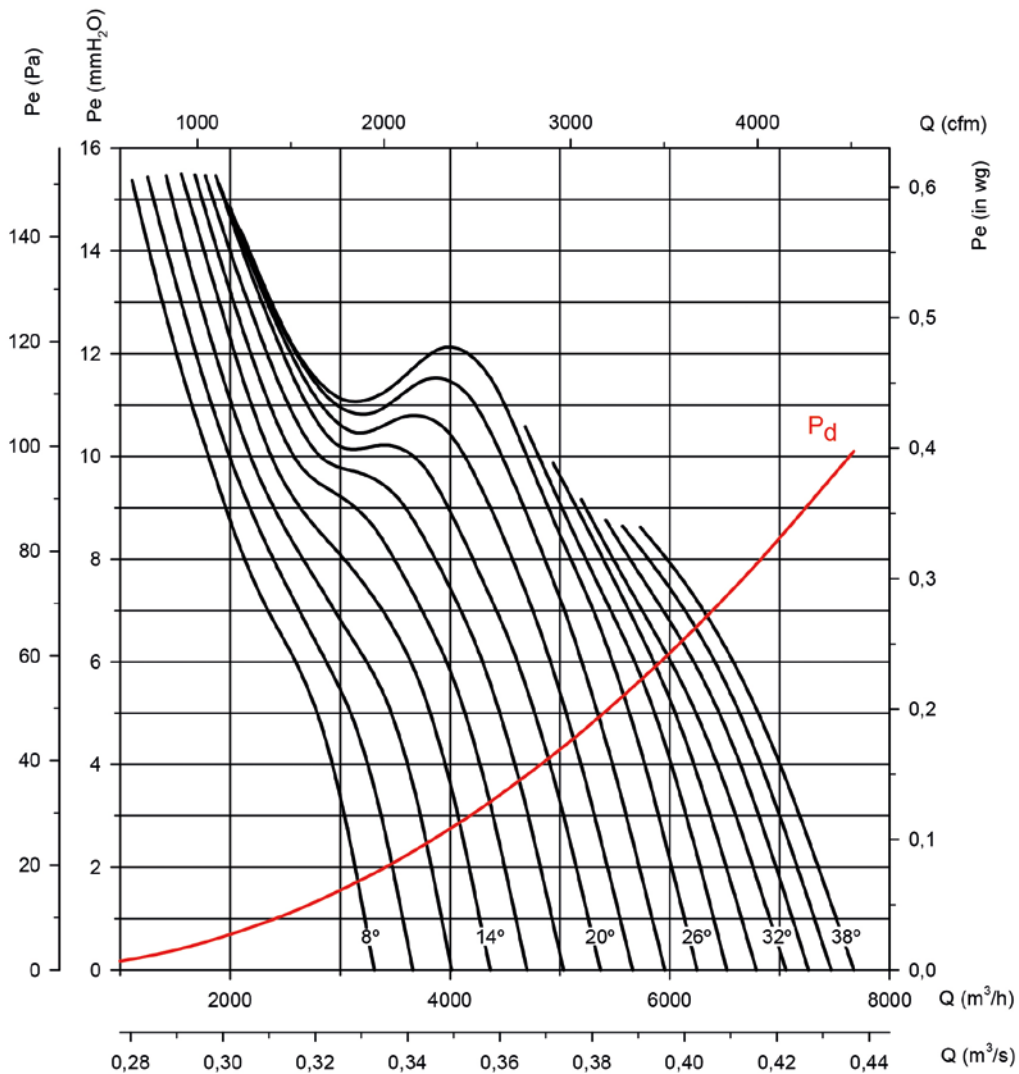

Absorbed power

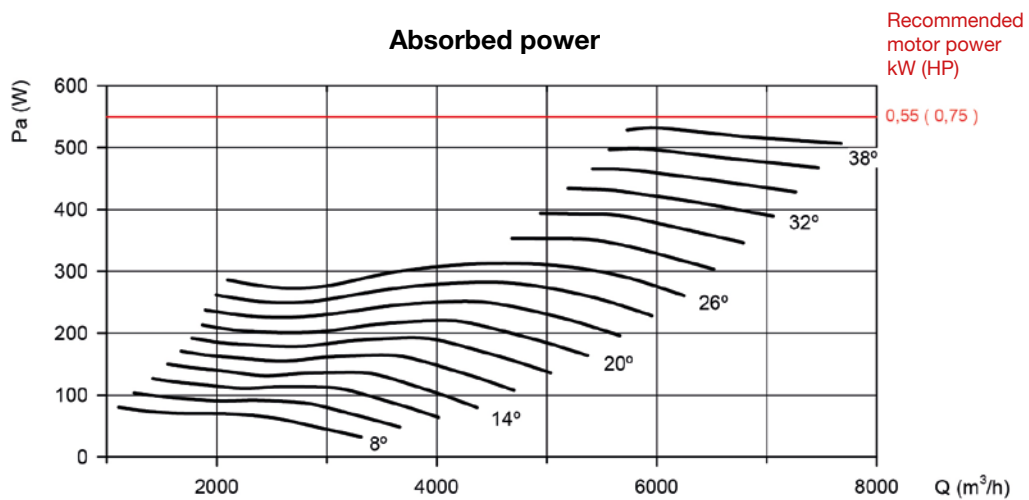

Characteristic curves

Q= Flow rate in m³/h, m³/s and cfm Pe= Static pressure in mm H₂O, Pa and inwg

Impeller diameter in cm: 45

Number of motor poles: 6

Number of blades: 6

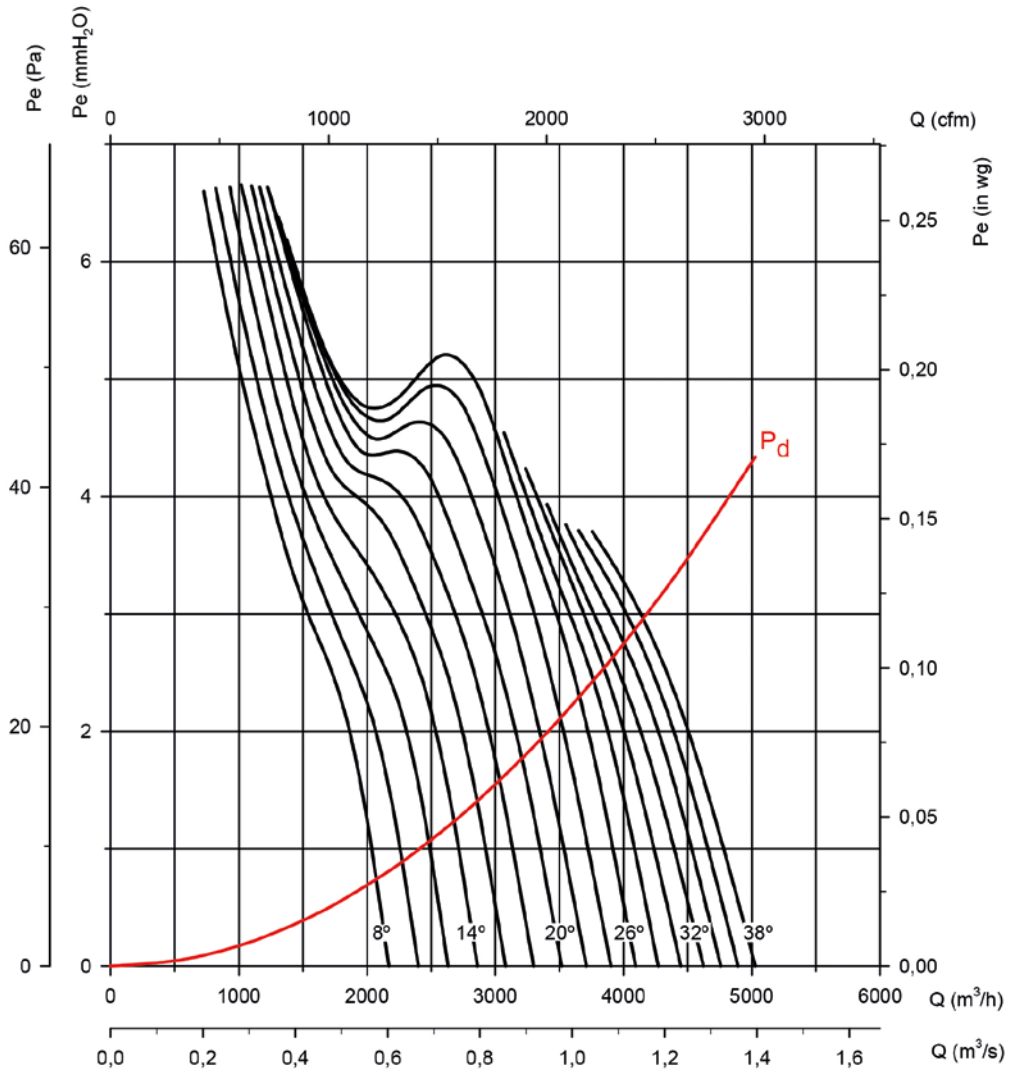

Absorbed power

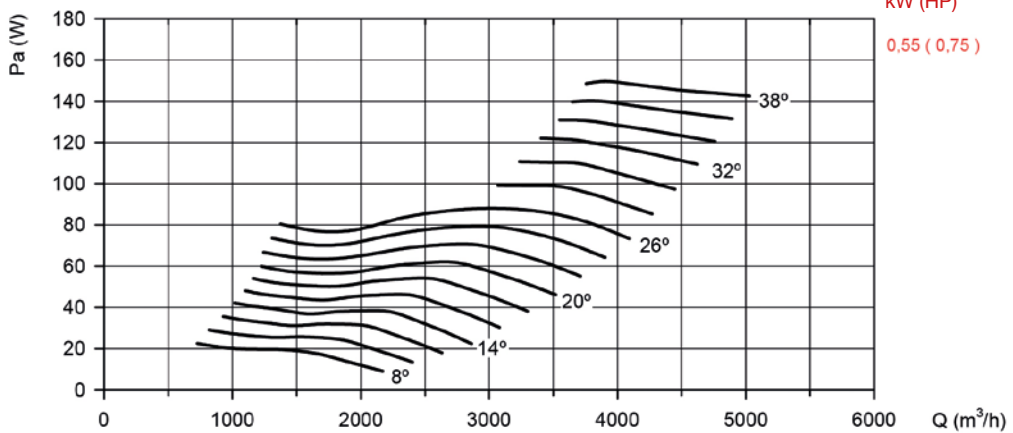

Recommended
motor power
kW (HP)
0,55 (0,75)

Characteristic curves

Q= Flow rate in m³/h, m³/s and cfm Pe= Static pressure in mm H₂O, Pa and inwg

Impeller diameter in cm: 50

Number of motor poles: 2

Number of blades: 6

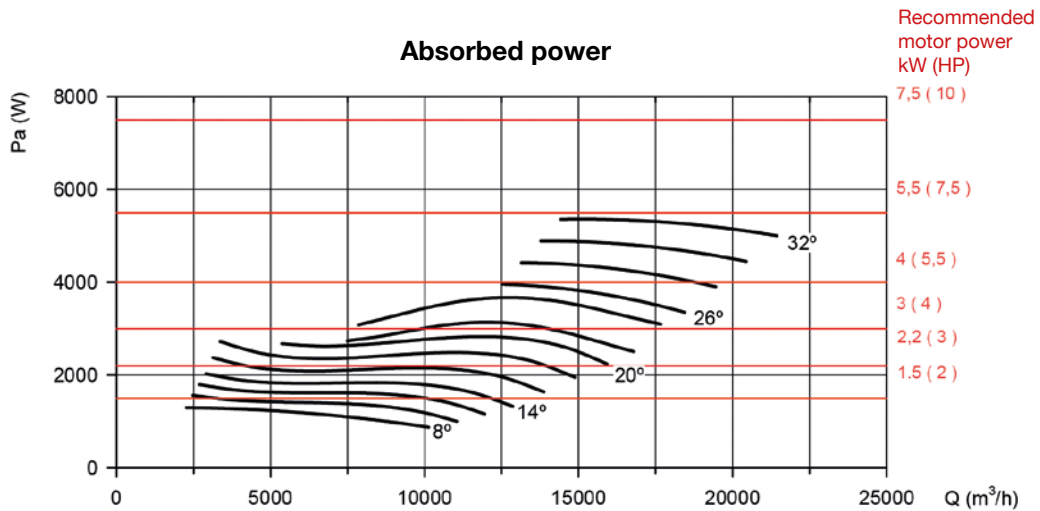
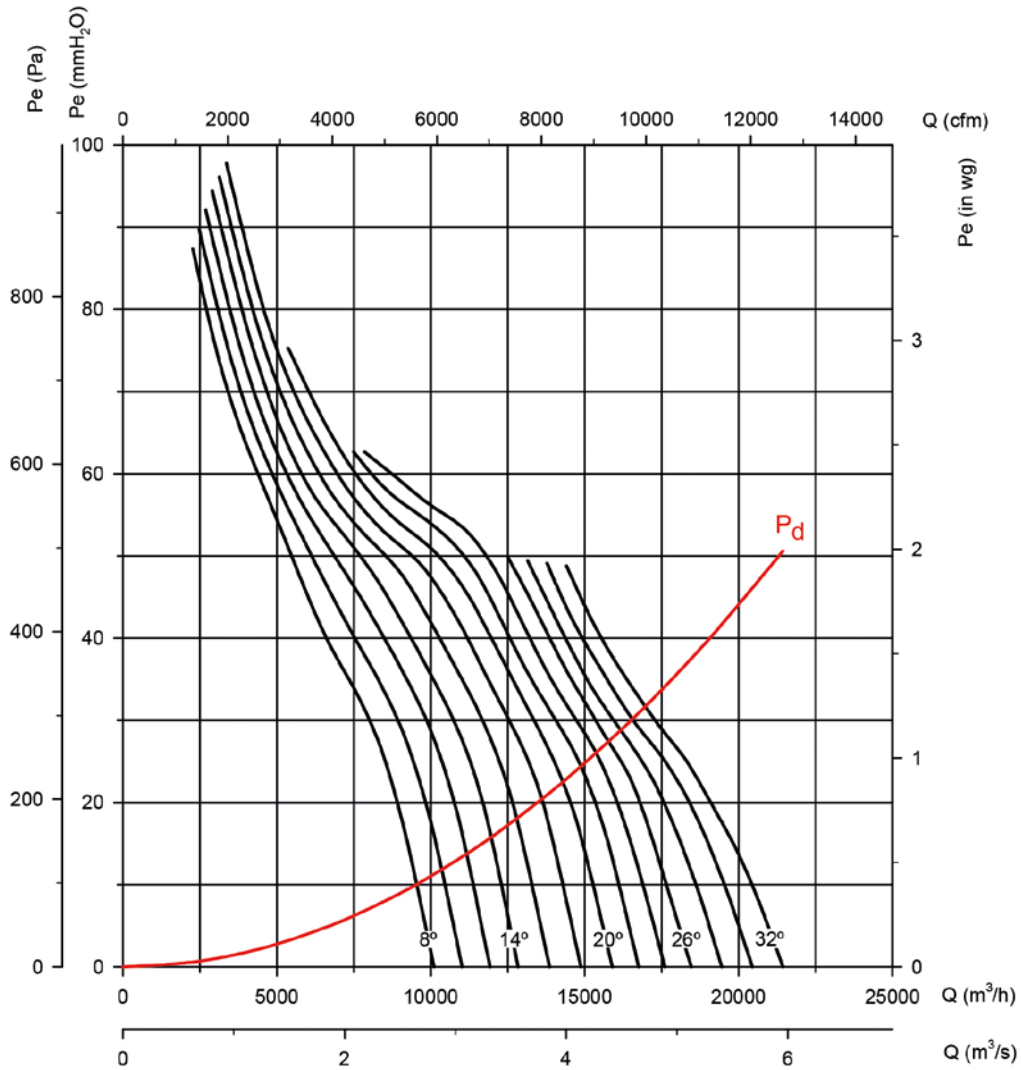

Characteristic curves

Q= Flow rate in m³/h, m³/s and cfm Pe= Static pressure in mm H₂O, Pa and inwg

Impeller diameter in cm: 50

Number of motor poles: 4

Number of blades: 6

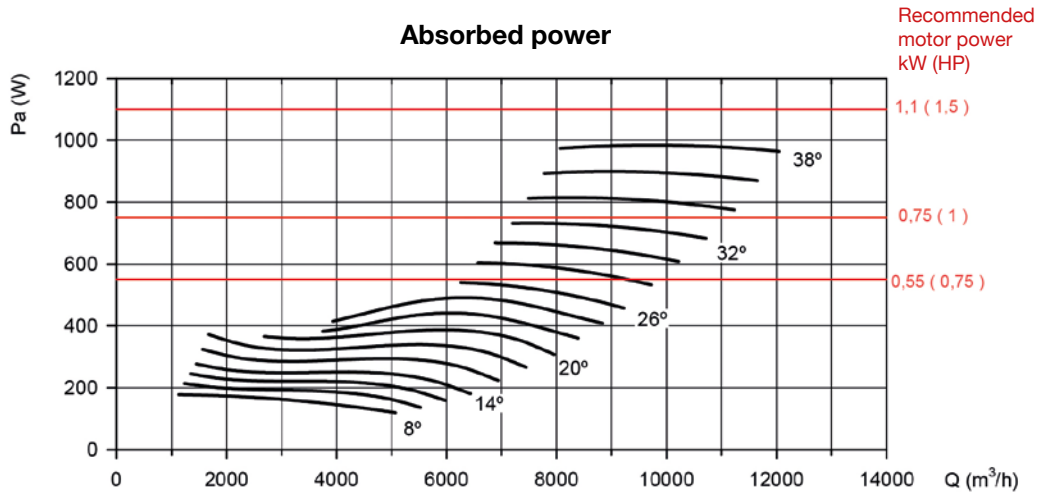
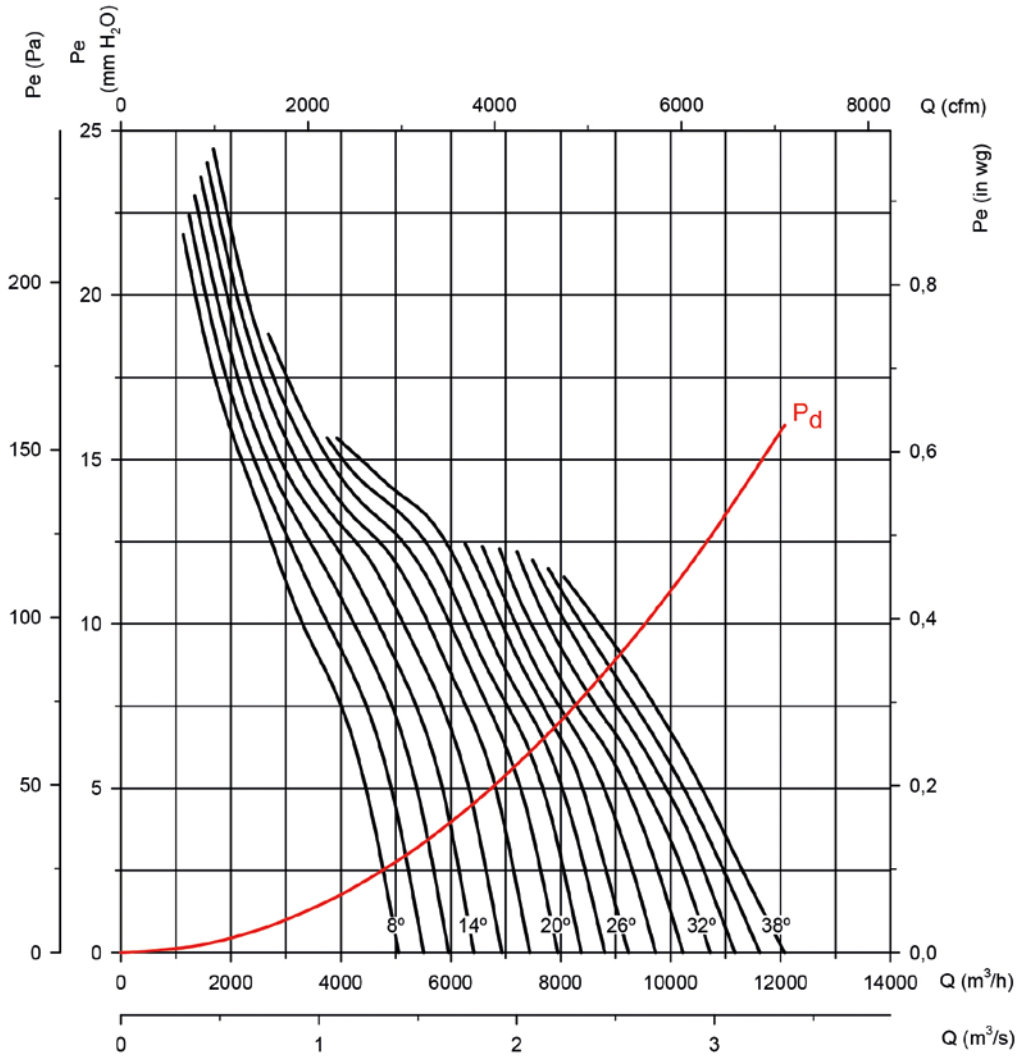

Characteristic curves

Q= Flow rate in m³/h, m³/s and cfm

Pe= Static pressure in mm H₂O, Pa and inwg

Impeller diameter in cm: 50

Number of motor poles: 6

Number of blades: 6

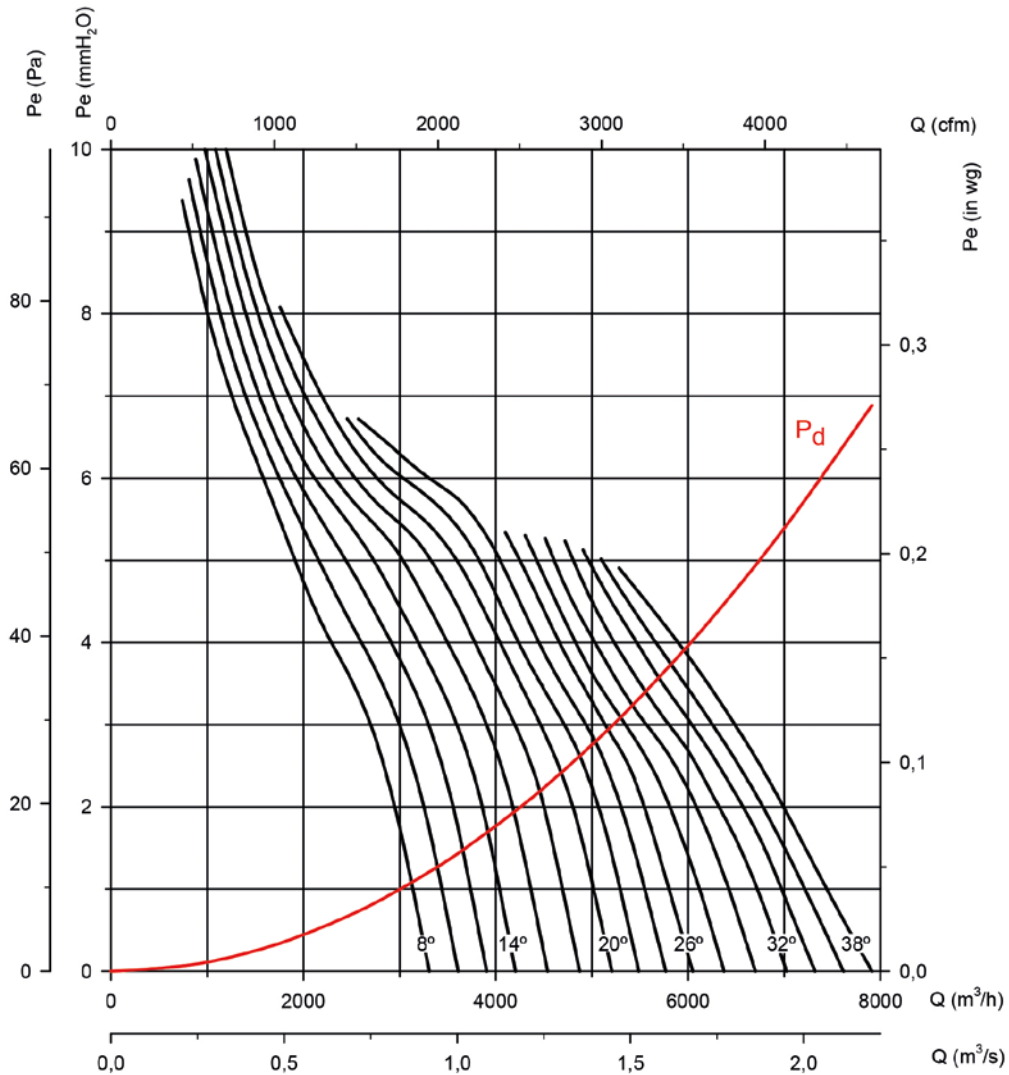

Absorbed power

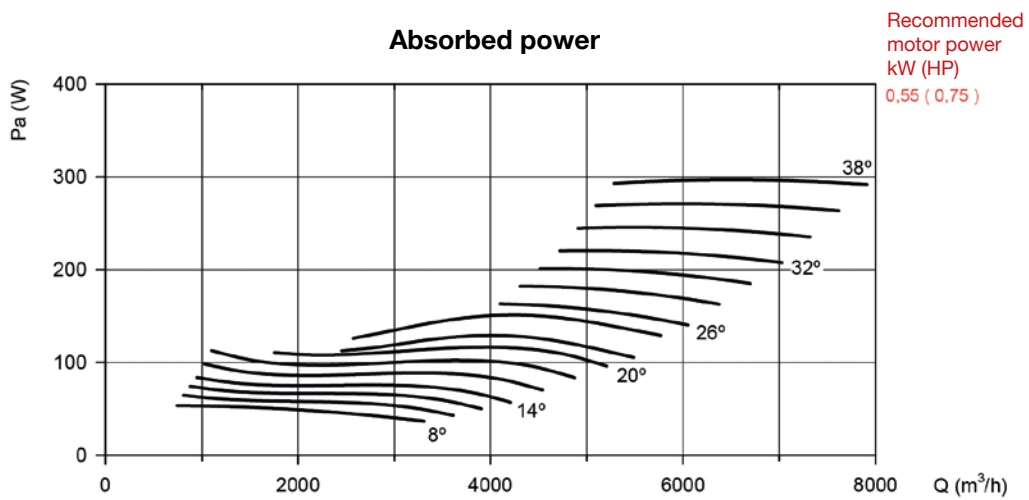

Characteristic curves

Q= Flow rate in m³/h, m³/s and cfm Pe= Static pressure in mm H₂O, Pa and inwg

Impeller diameter in cm: 56

Number of motor poles: 2

Number of blades: 6

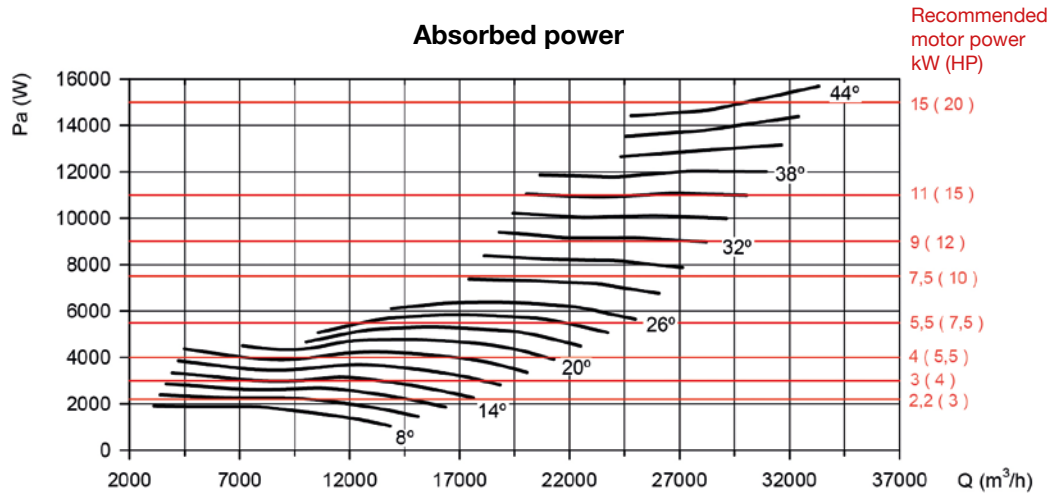
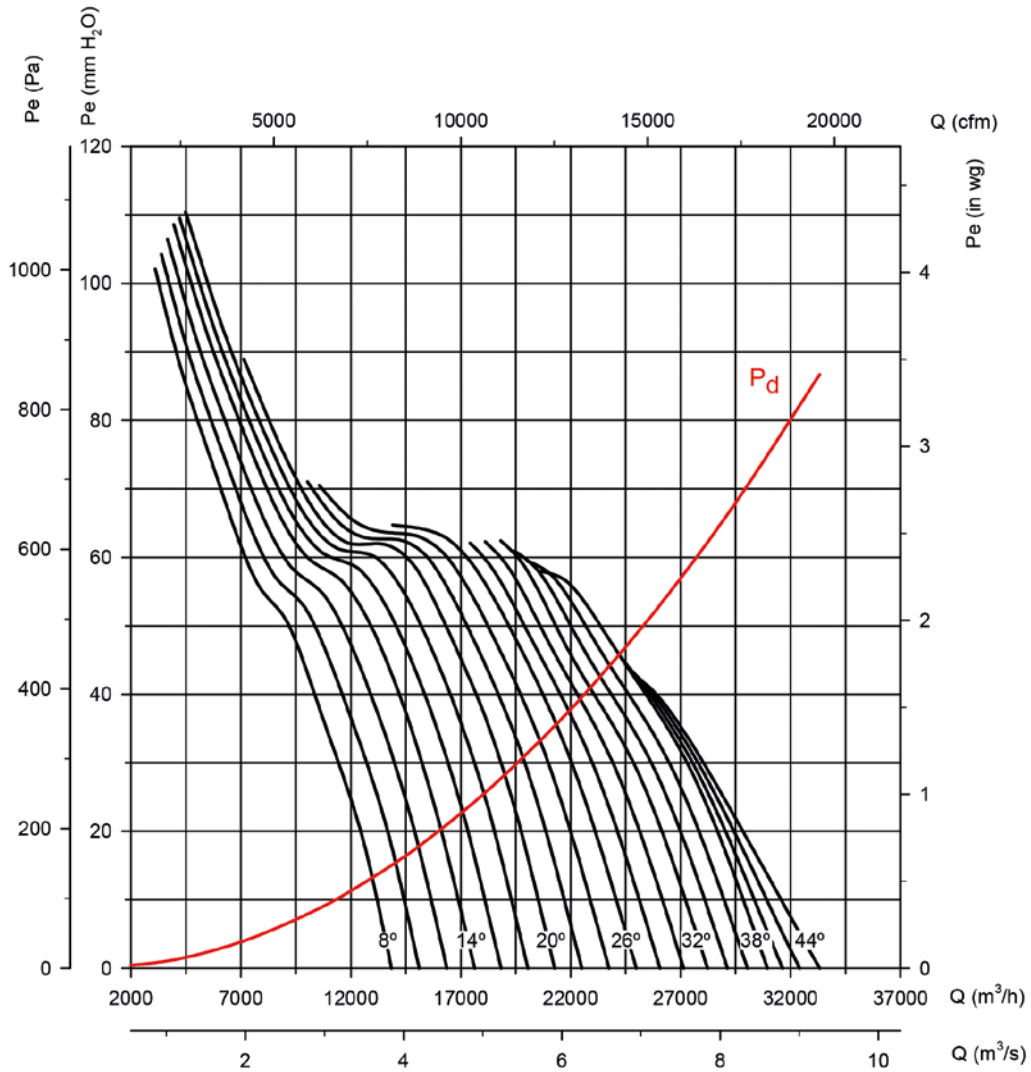

Characteristic curves

Q= Flow rate in m³/h, m³/s and cfm

Pe= Static pressure in mm H₂O, Pa and inwg

Impeller diameter in cm: 56

Number of motor poles: 4

Number of blades: 6

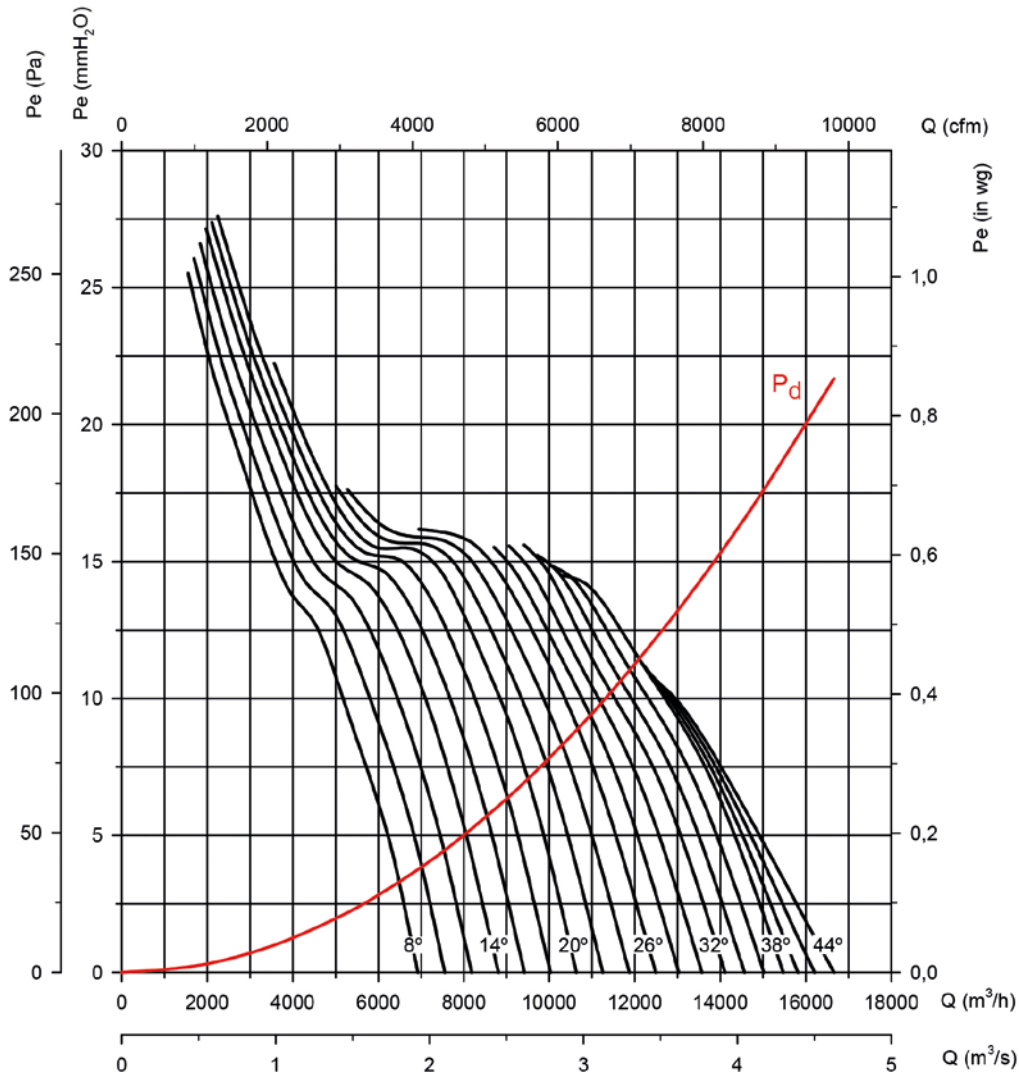

Absorbed power

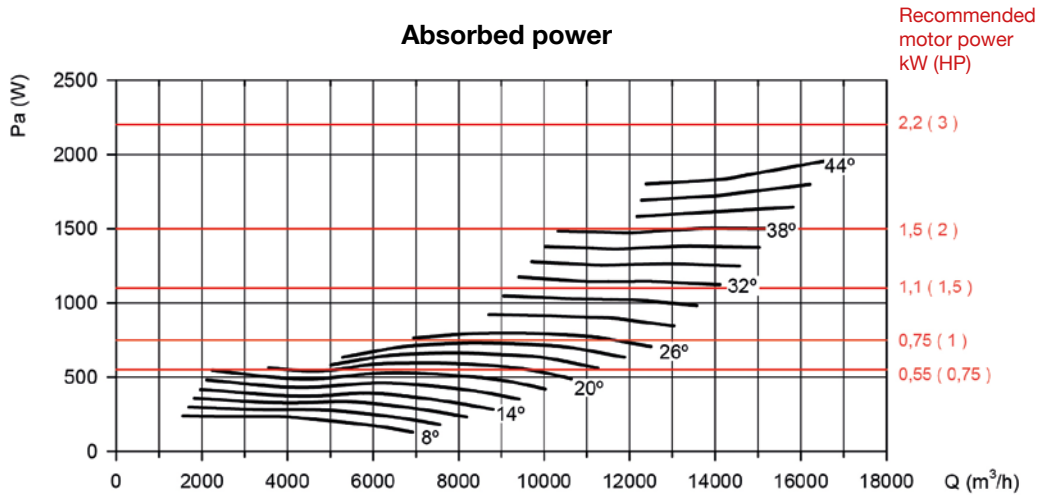

Characteristic curves

Q= Flow rate in m³/h, m³/s and cfm

Pe= Static pressure in mm H₂O, Pa and inwg

Impeller diameter in cm: 56

Number of motor poles: 6

Number of blades: 6

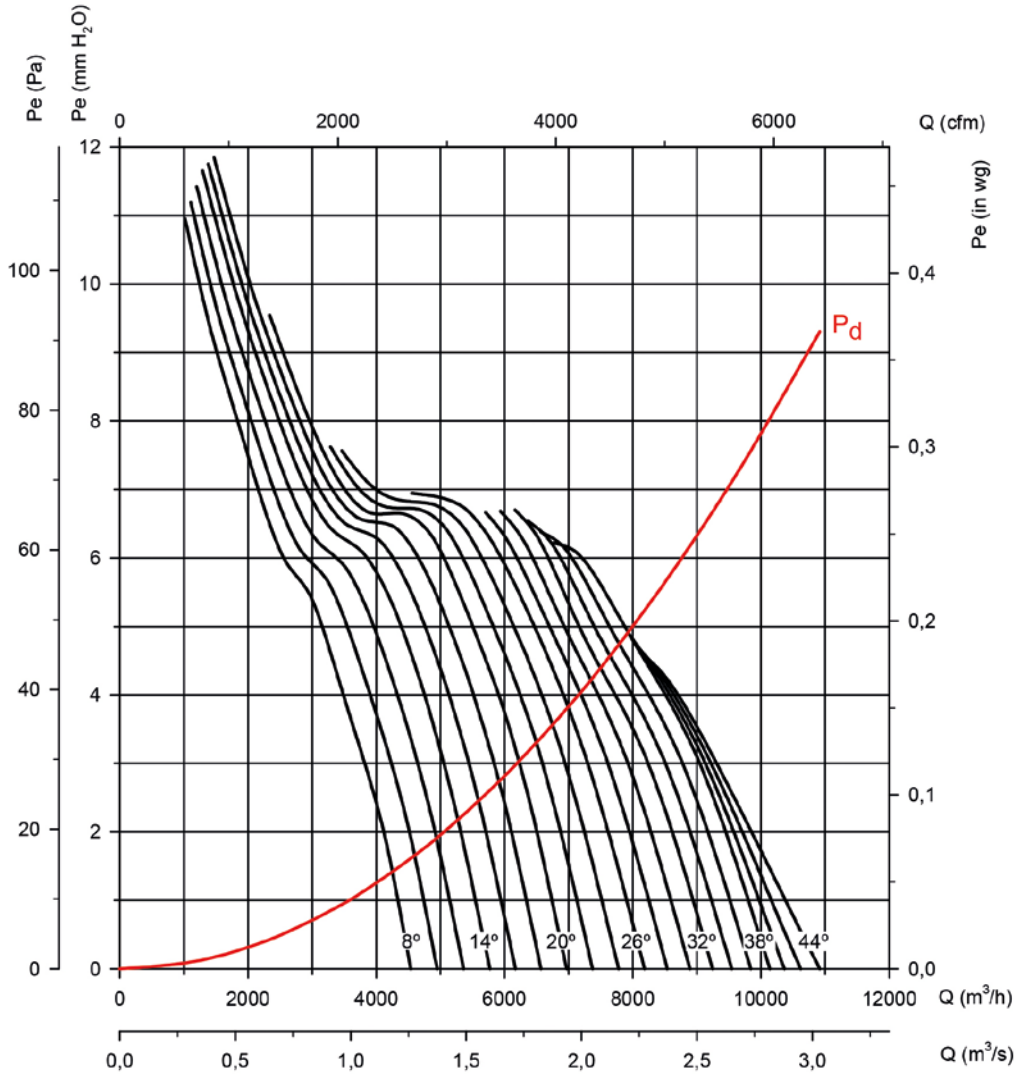

Absorbed power

Recommended motor power kW (HP)

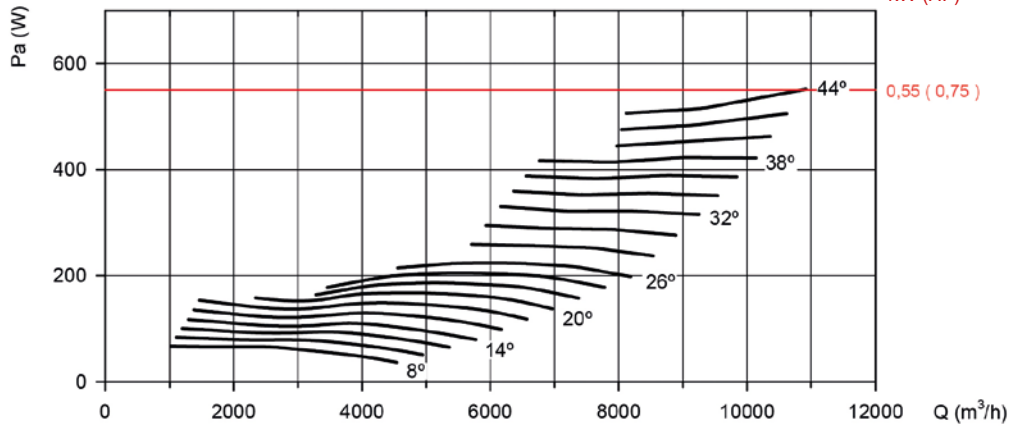

Characteristic curves

Q= Flow rate in m³/h, m³/s and cfm

Pe= Static pressure in mm H₂O, Pa and inwg

Impeller diameter in cm: 63

Number of motor poles: 2

Number of blades: 6

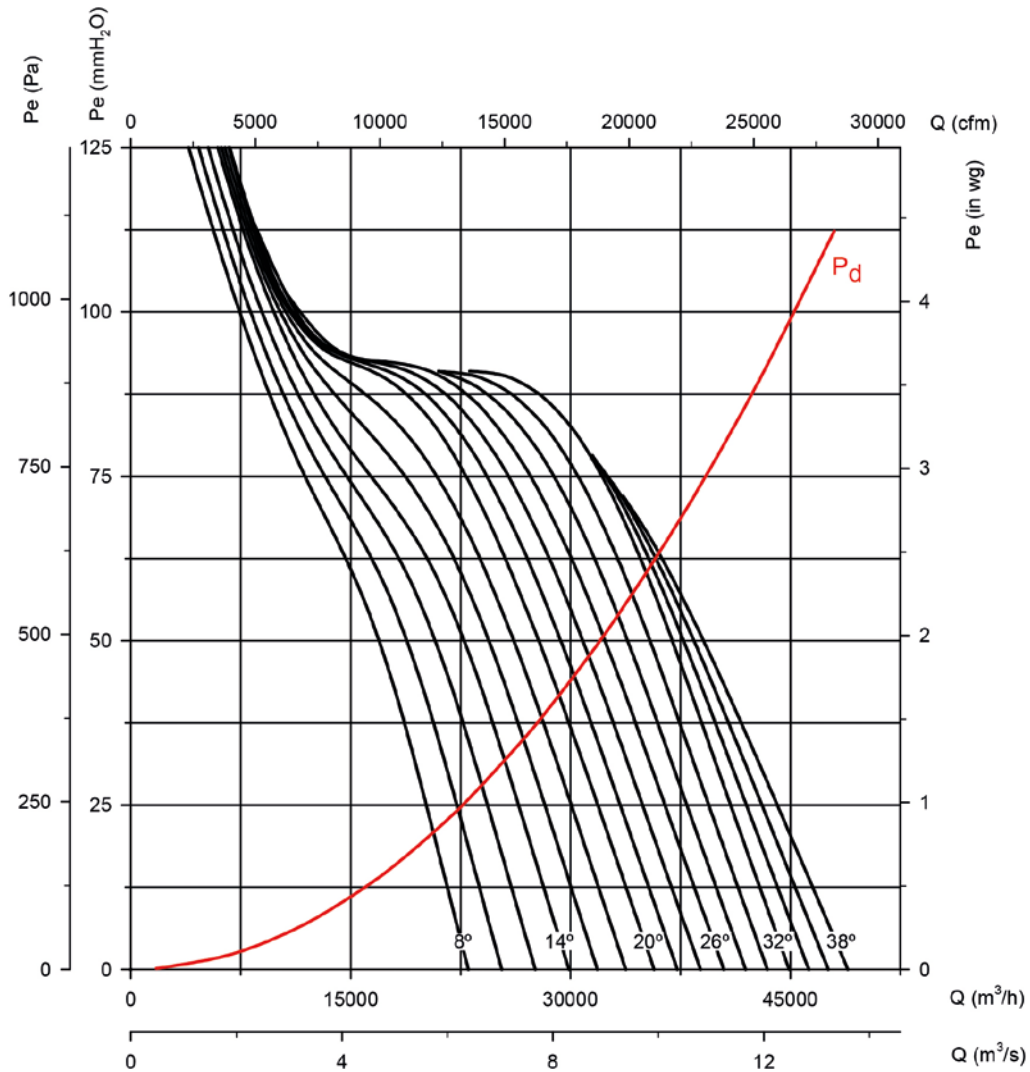

Absorbed power

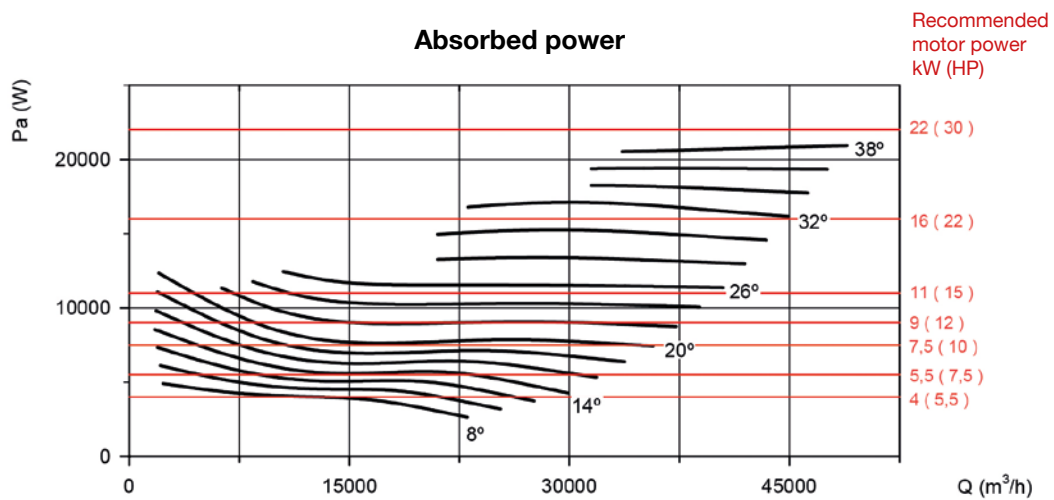

Characteristic curves

Q= Flow rate in m³/h, m³/s and cfm

Pe= Static pressure in mm H₂O, Pa and inwg

Impeller diameter in cm: 63

Number of motor poles: 4

Number of blades: 6

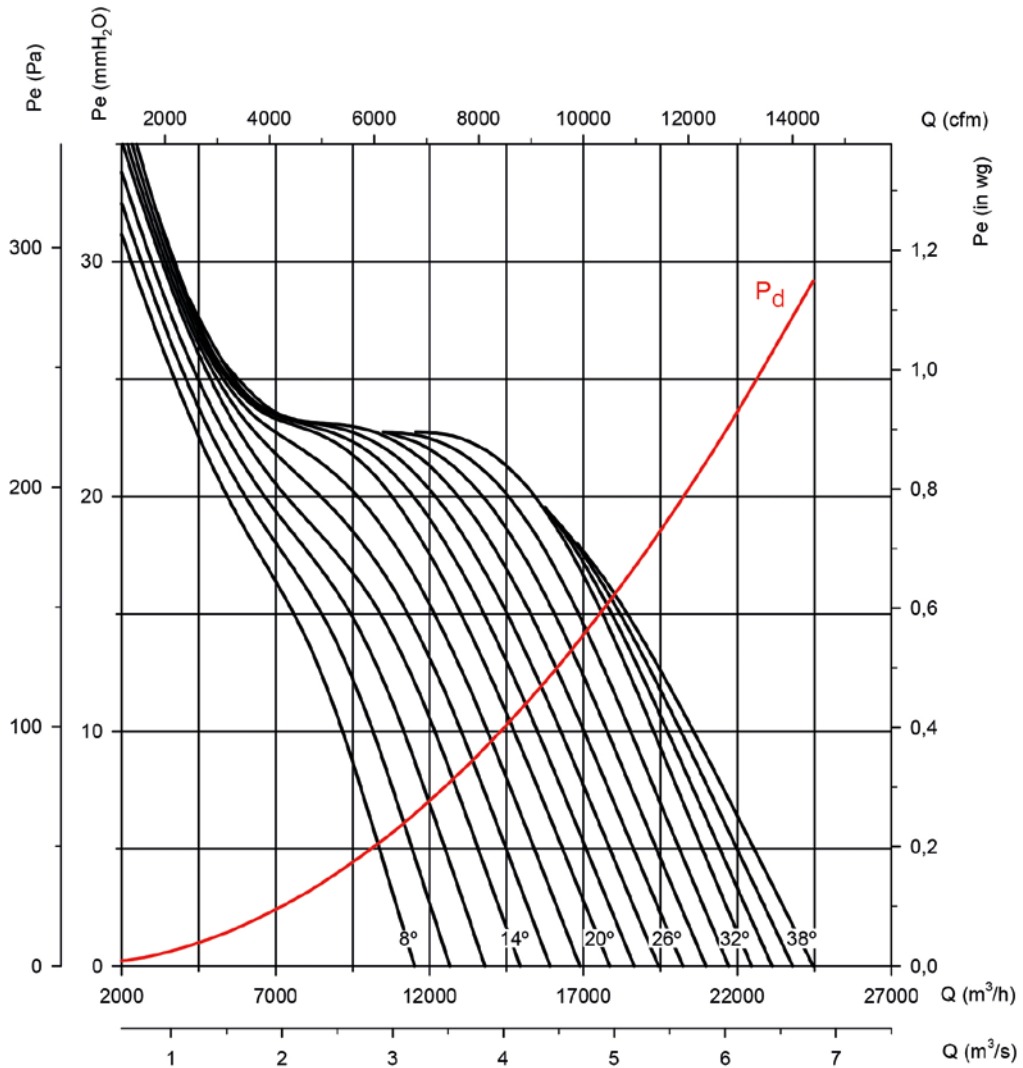

Absorbed power

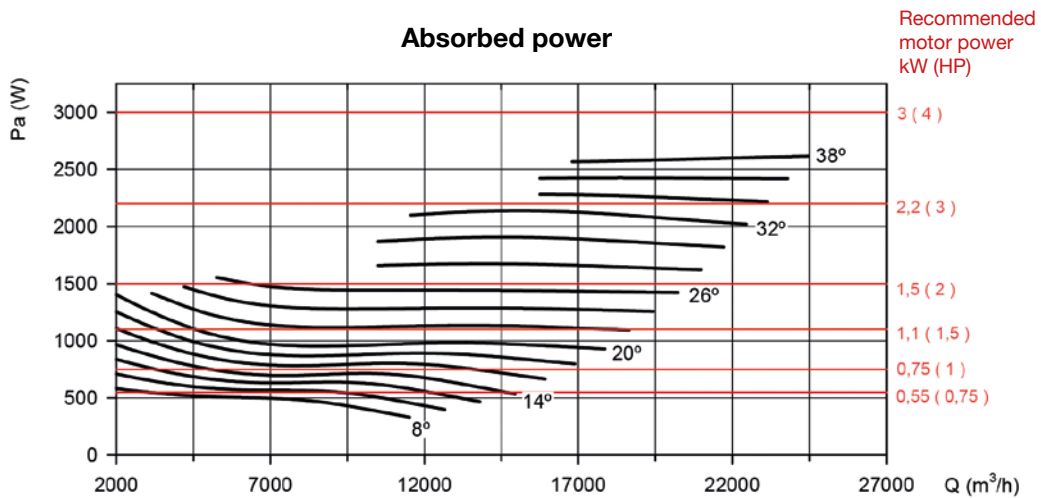

Characteristic curves

Q= Flow rate in m³/h, m³/s and cfm

Pe= Static pressure in mm H₂O, Pa and inwg

Impeller diameter in cm: 63

Number of motor poles: 6

Number of blades: 6

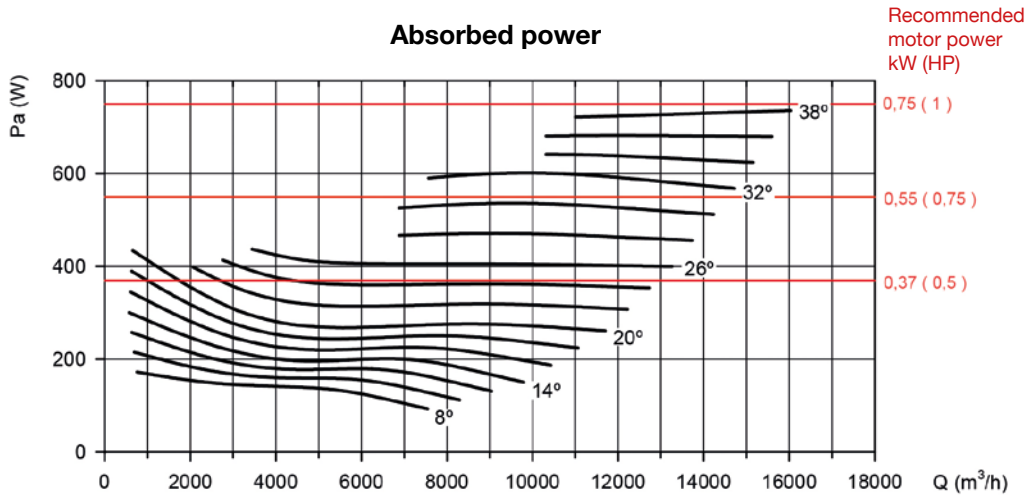
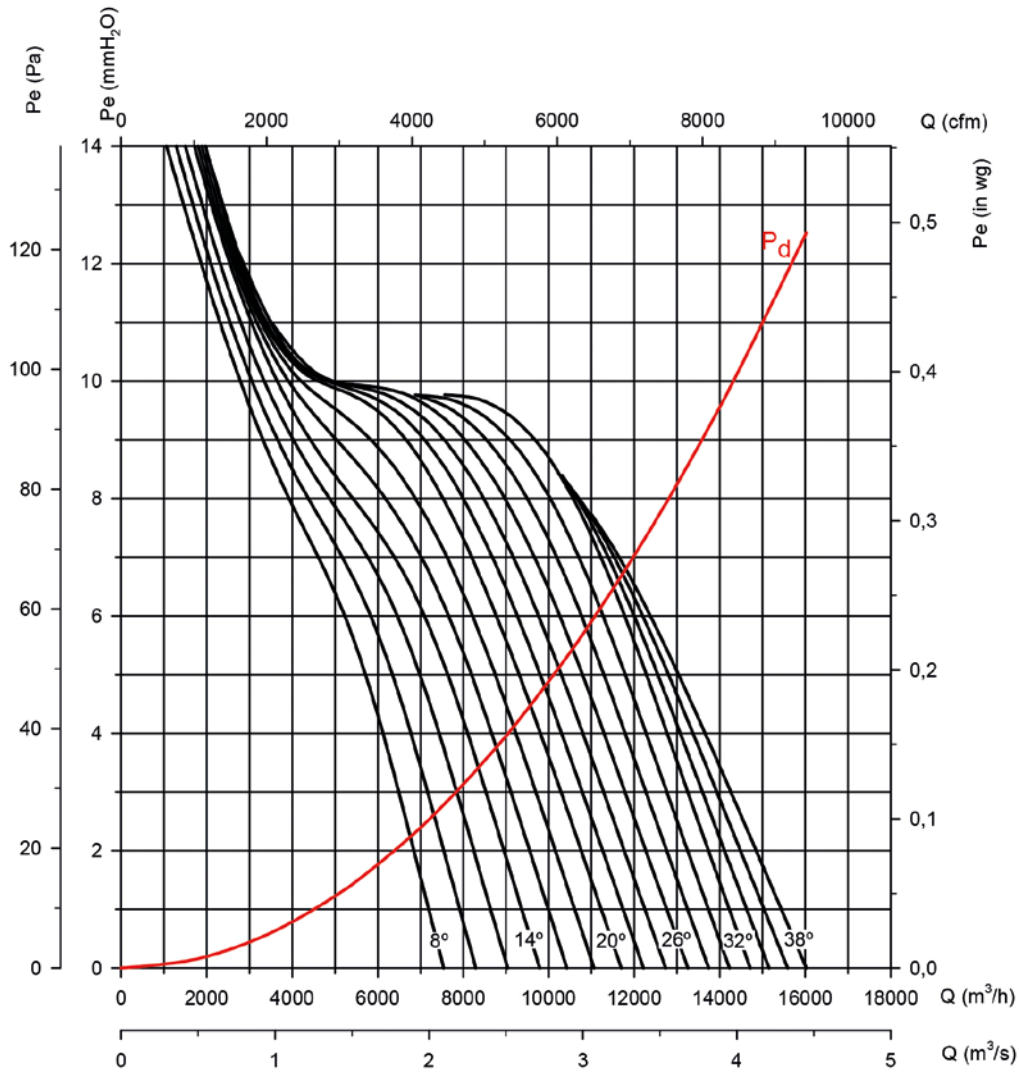

Characteristic curves

Q= Flow rate in m³/h, m³/s and cfm

Pe= Static pressure in mm H₂O, Pa and inwg

Impeller diameter in cm: 71

Number of motor poles: 4

Number of blades: 6

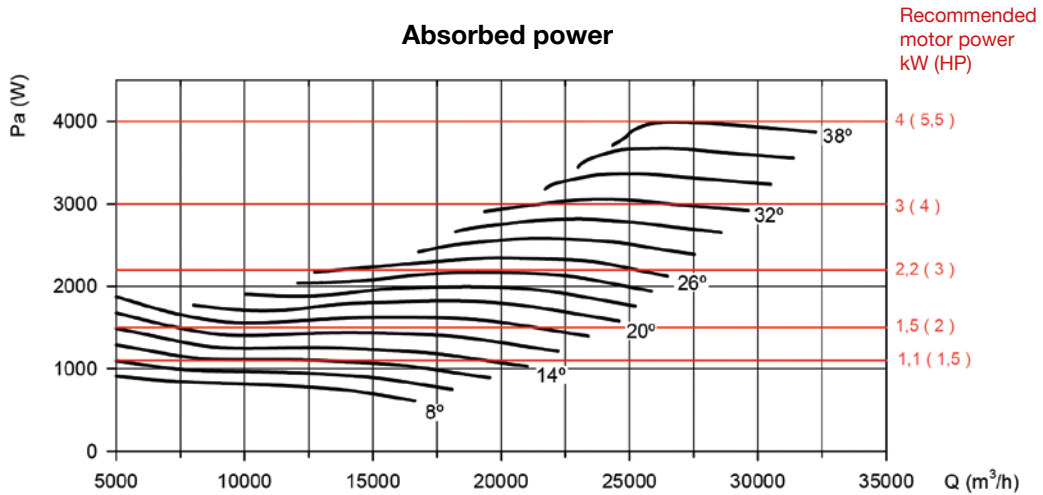
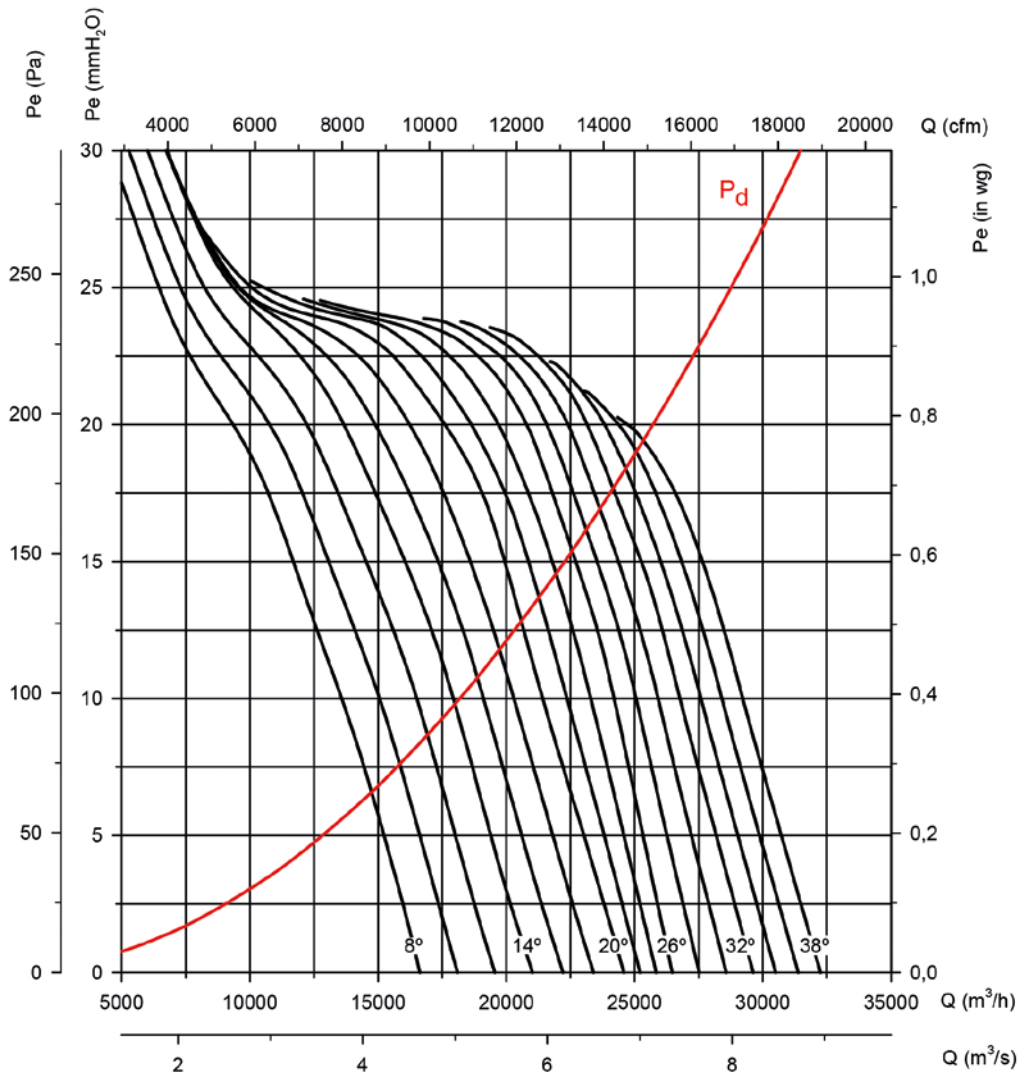

Characteristic curves

Q= Flow rate in m³/h, m³/s and cfm

Pe= Static pressure in mm H₂O, Pa and inwg

Impeller diameter in cm: 71

Number of motor poles: 6

Number of blades: 6

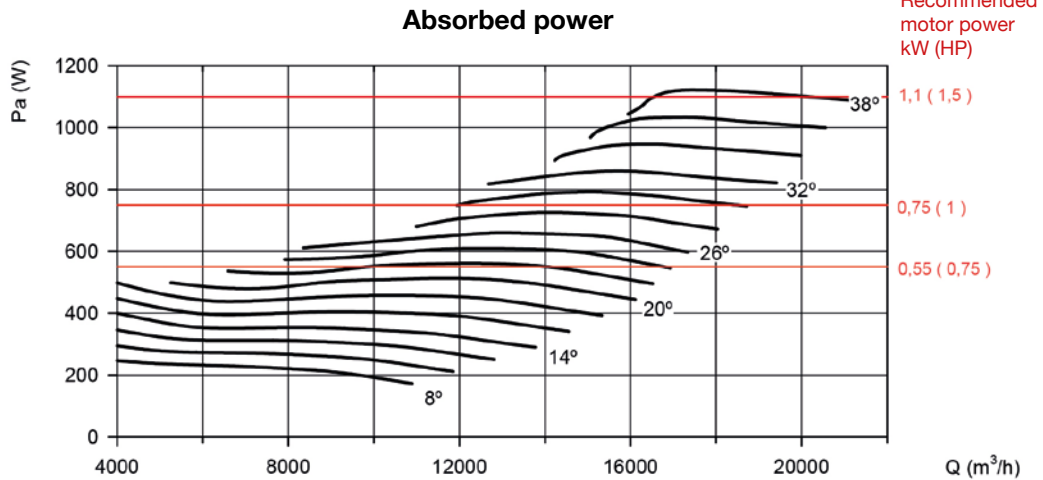
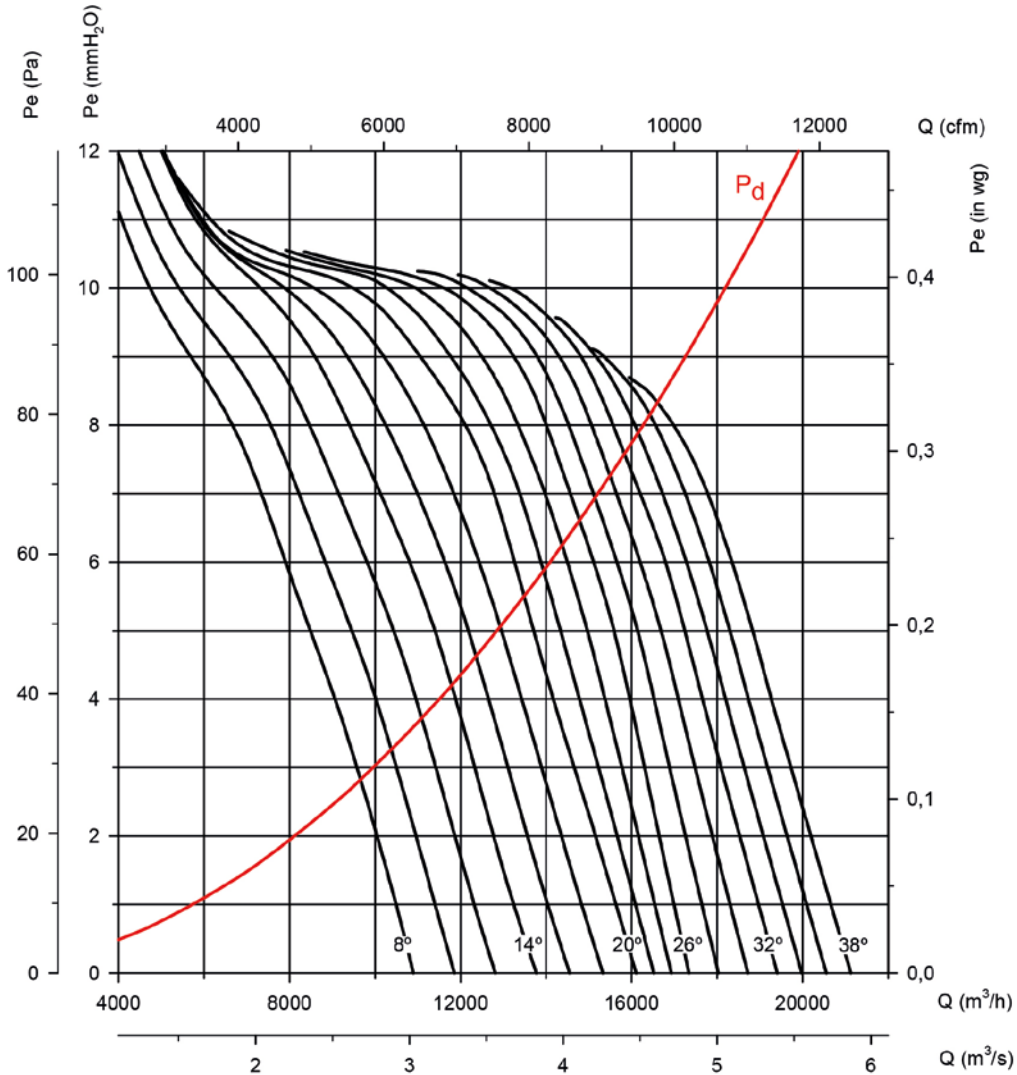

Characteristic curves

Q= Flow rate in m³/h, m³/s and cfm Pe= Static pressure in mm H₂O, Pa and inwg

Impeller diameter in cm: 80

Number of motor poles: 4

Number of blades: 6

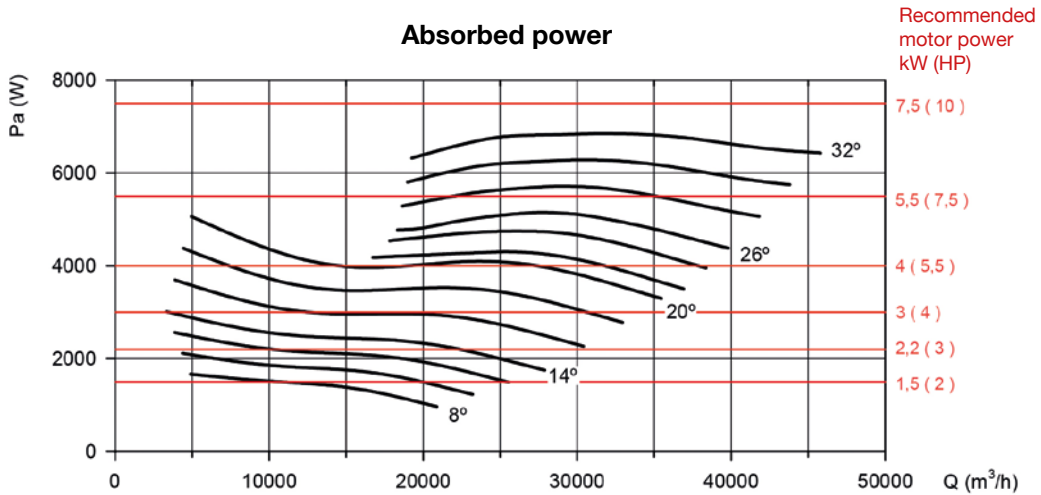
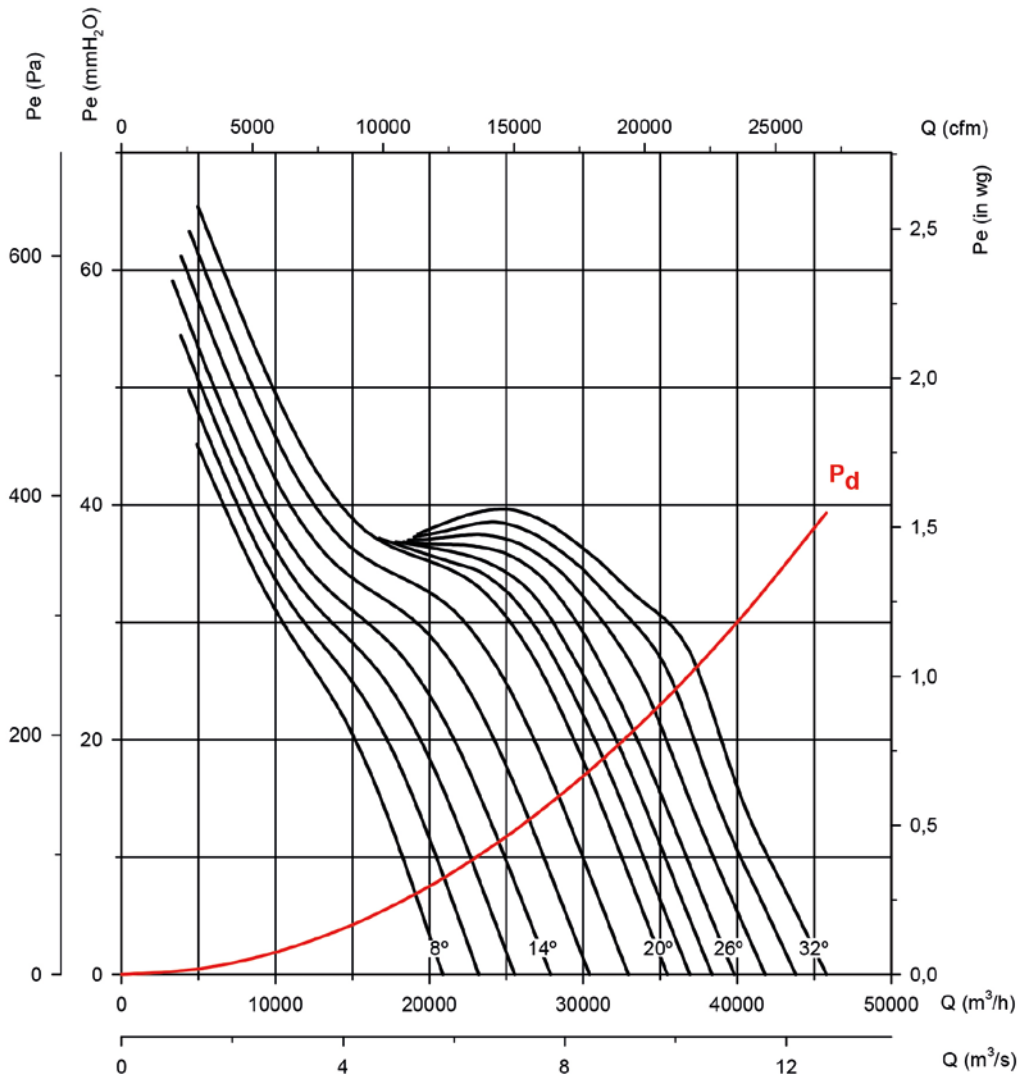

Characteristic curves

Q= Flow rate in m³/h, m³/s and cfm

Pe= Static pressure in mm H₂O, Pa and inwg

Impeller diameter in cm: 80

Number of motor poles: 6

Number of blades: 6

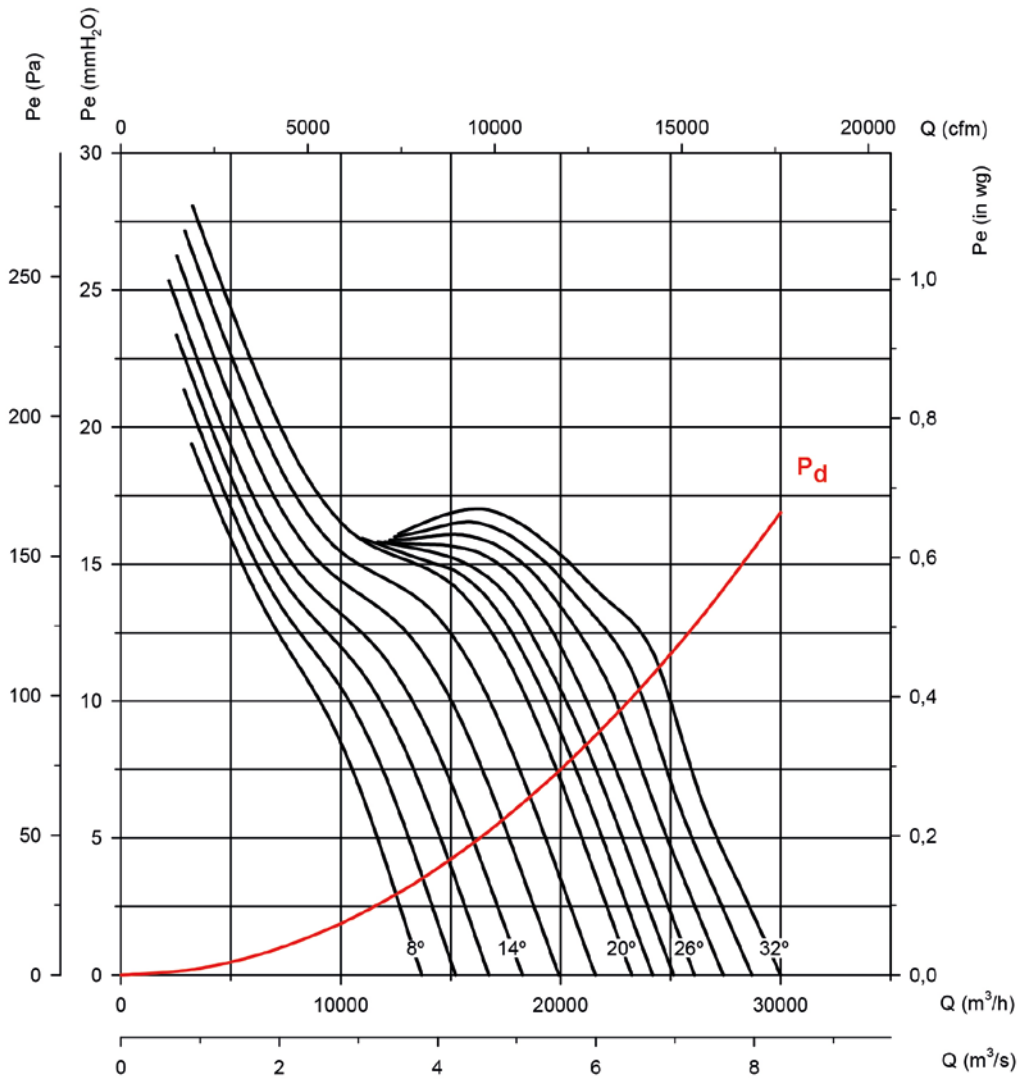

Absorbed power

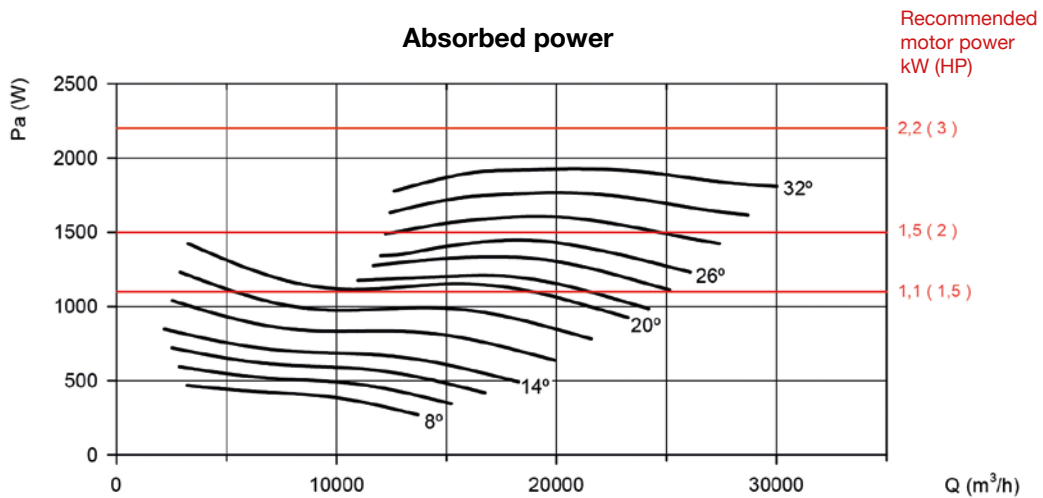

Characteristic curves

Q= Flow rate in m³/h, m³/s and cfm

Pe= Static pressure in mm H₂O, Pa and inwg

Impeller diameter in cm: 80

Number of motor poles: 8

Number of blades: 6

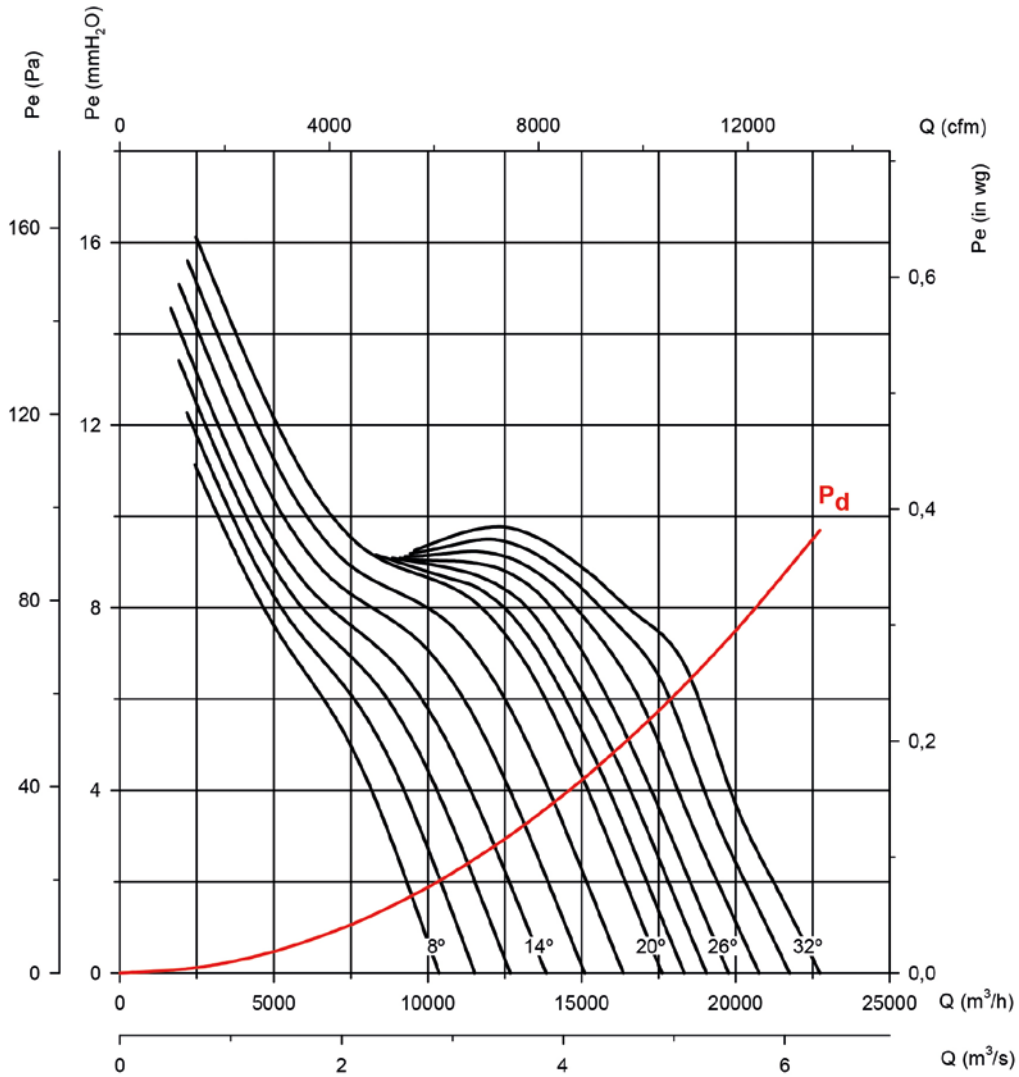

Absorbed power

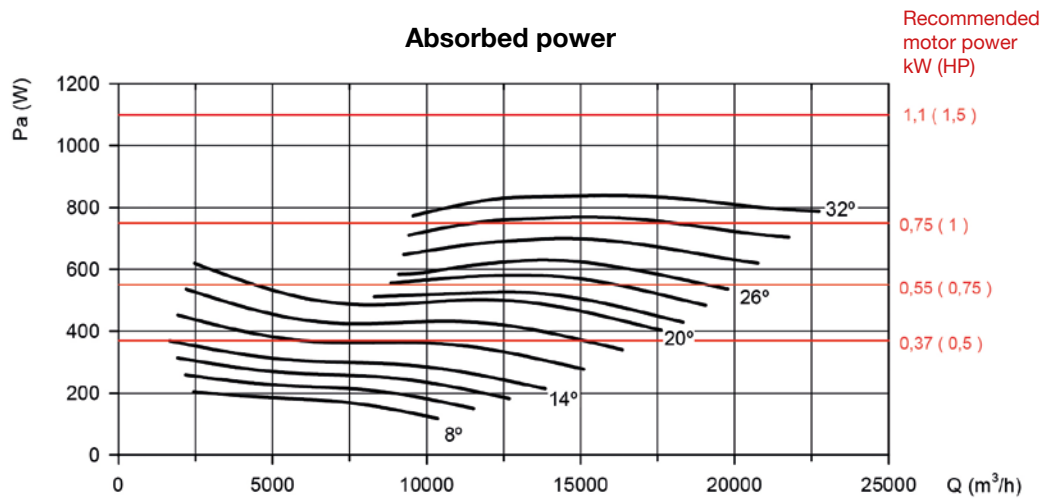

Characteristic curves

Q= Flow rate in m³/h, m³/s and cfm

Pe= Static pressure in mm H₂O, Pa and inwg

Impeller diameter in cm: 90

Number of motor poles: 4

Number of blades: 6

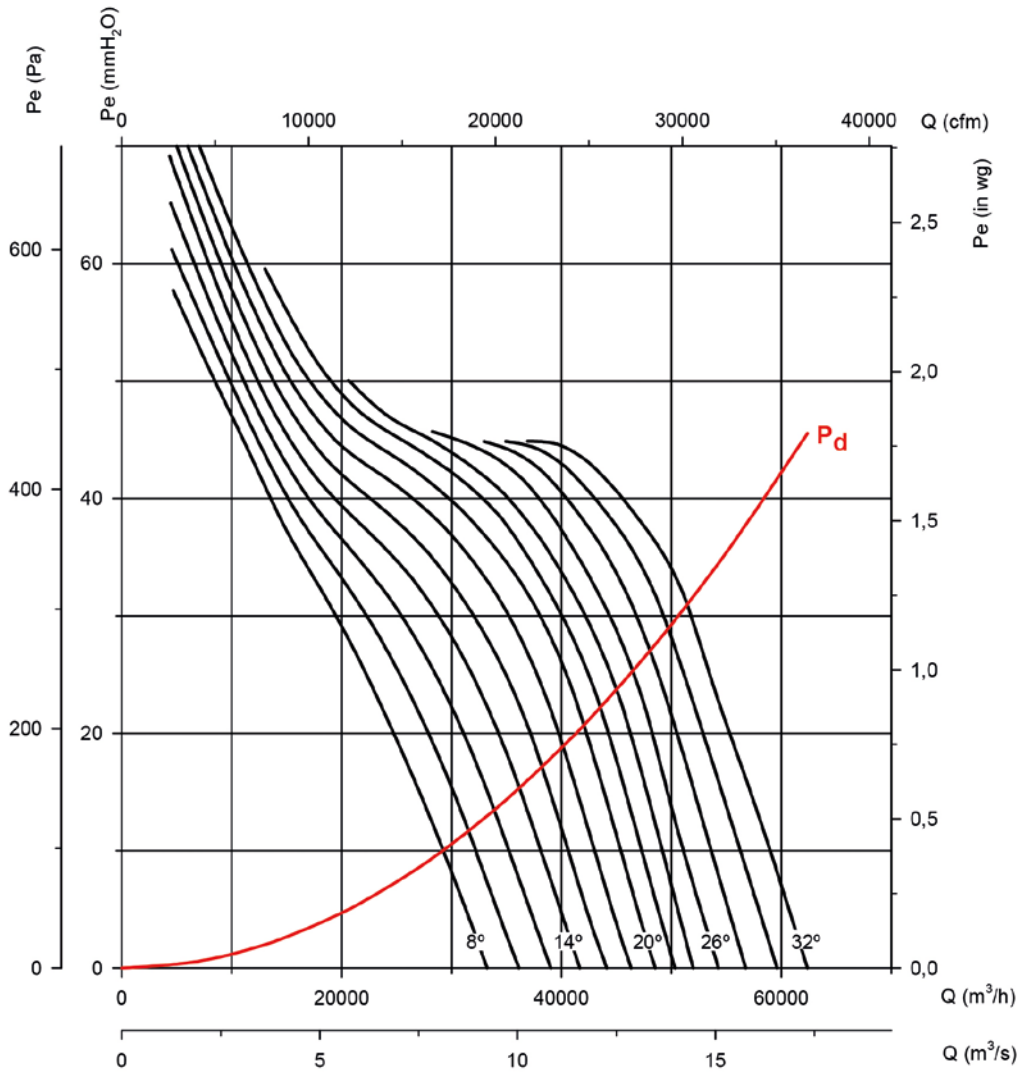

Absorbed power

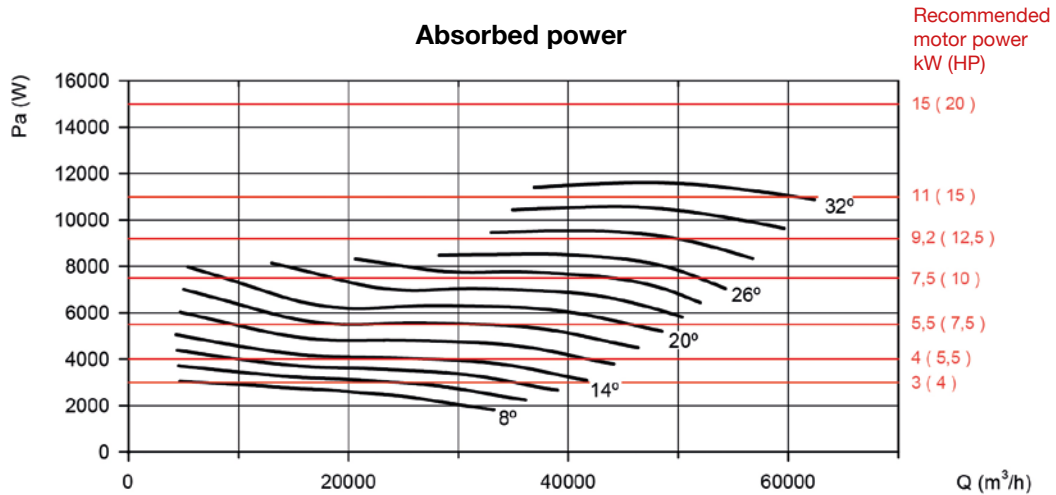

Characteristic curves

Q= Flow rate in m³/h, m³/s and cfm Pe= Static pressure in mm H₂O, Pa and inwg

Impeller diameter in cm: 90

Number of motor poles: 6

Number of blades: 6

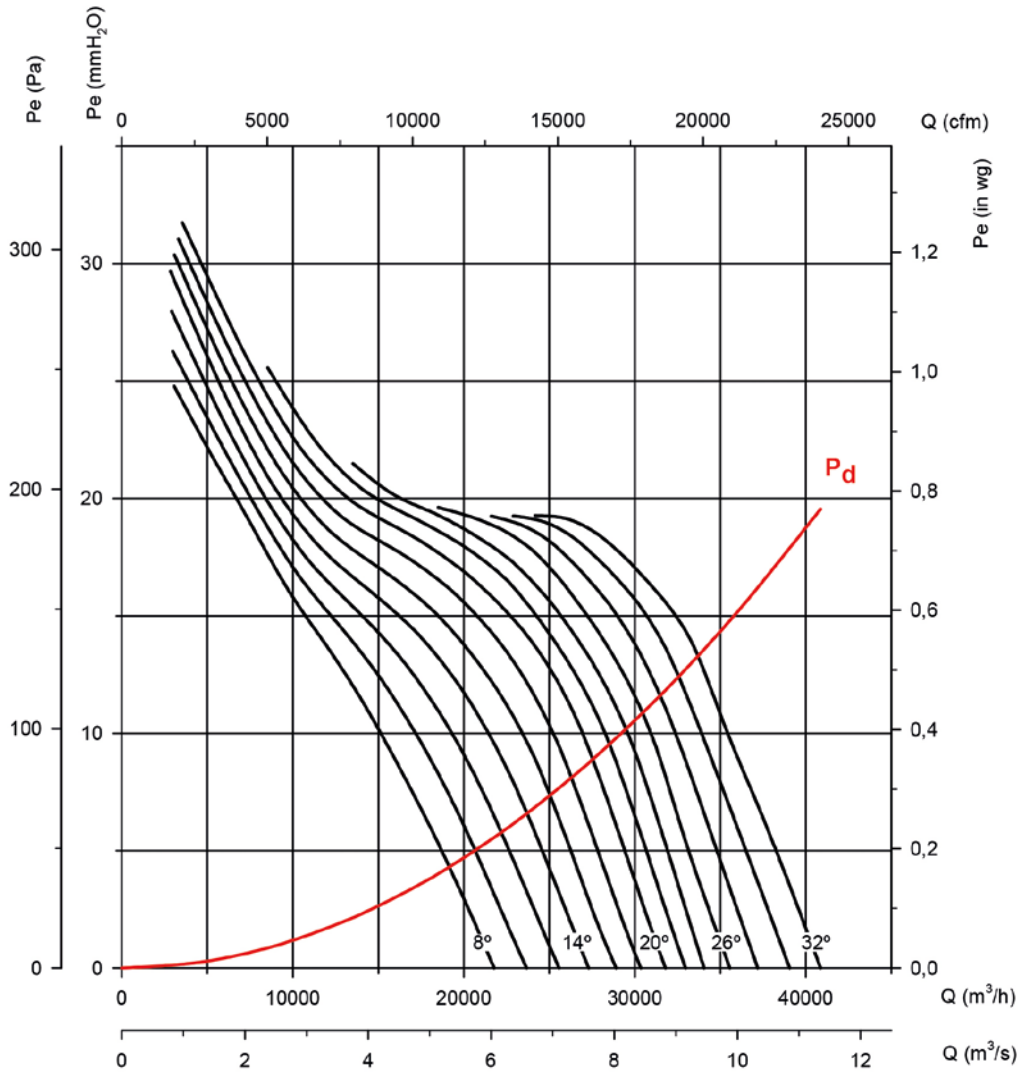

Absorbed power

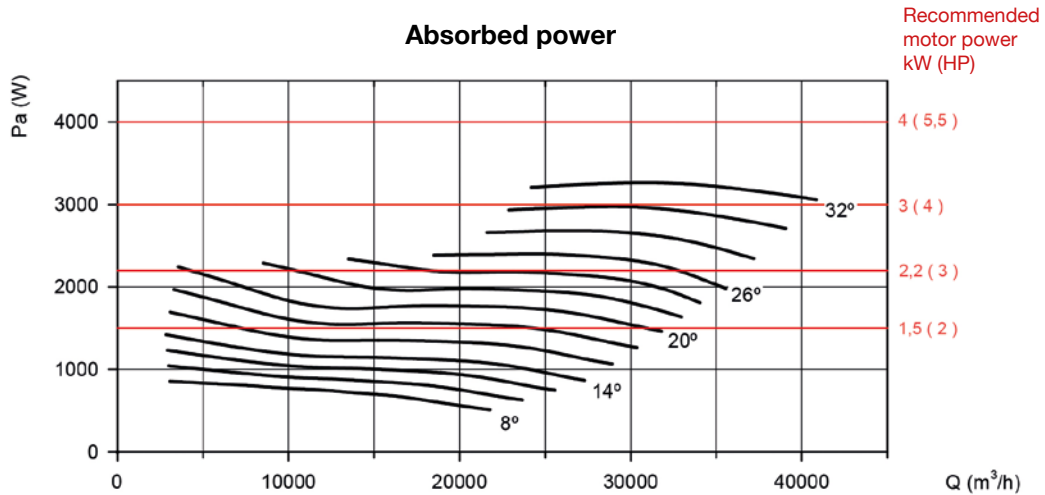

Characteristic curves

Q= Flow rate in m³/h, m³/s and cfm

Pe= Static pressure in mm H₂O, Pa and inwg

Impeller diameter in cm: 90

Number of motor poles: 8

Number of blades: 6

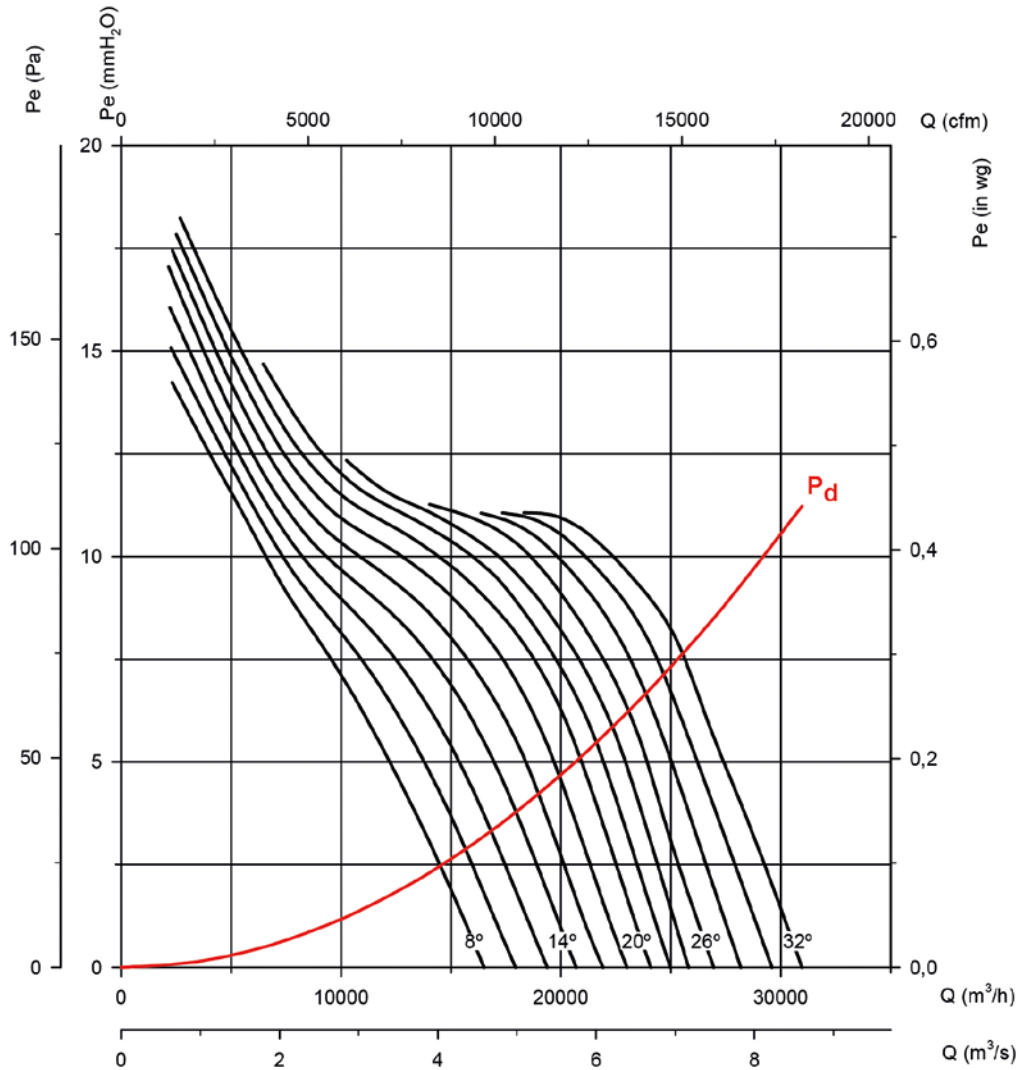

Absorbed power

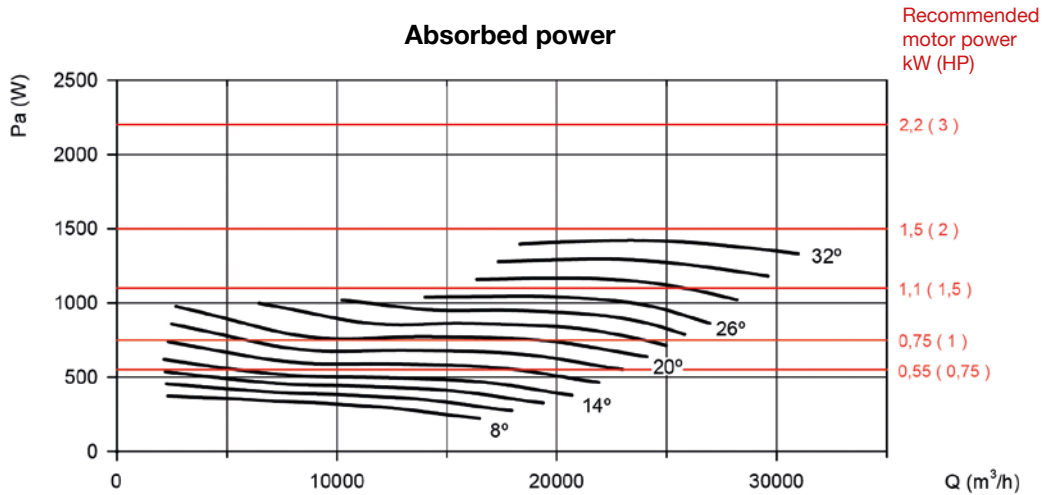

Characteristic curves

Q= Flow rate in m³/h, m³/s and cfm Pe= Static pressure in mm H₂O, Pa and inwg

Impeller diameter in cm: 100

Number of motor poles: 4

Number of blades: 6

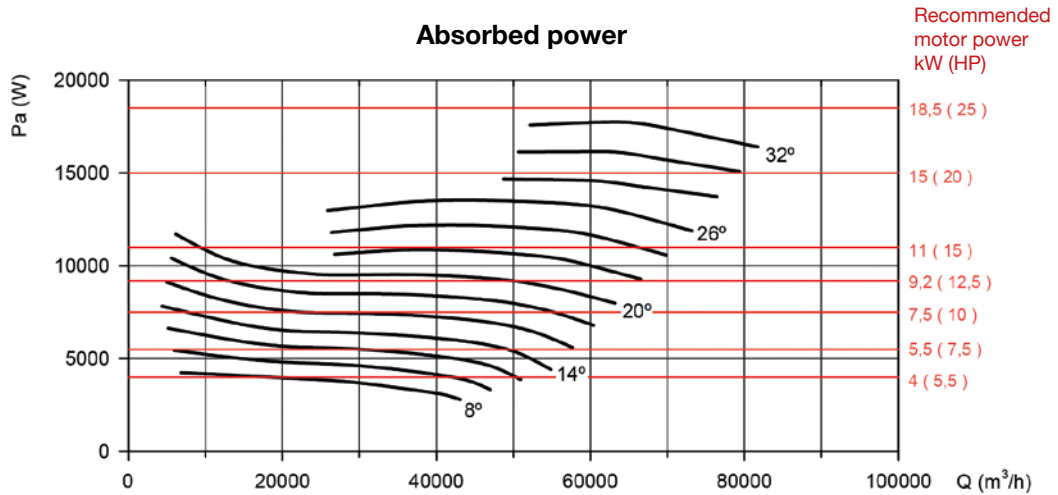
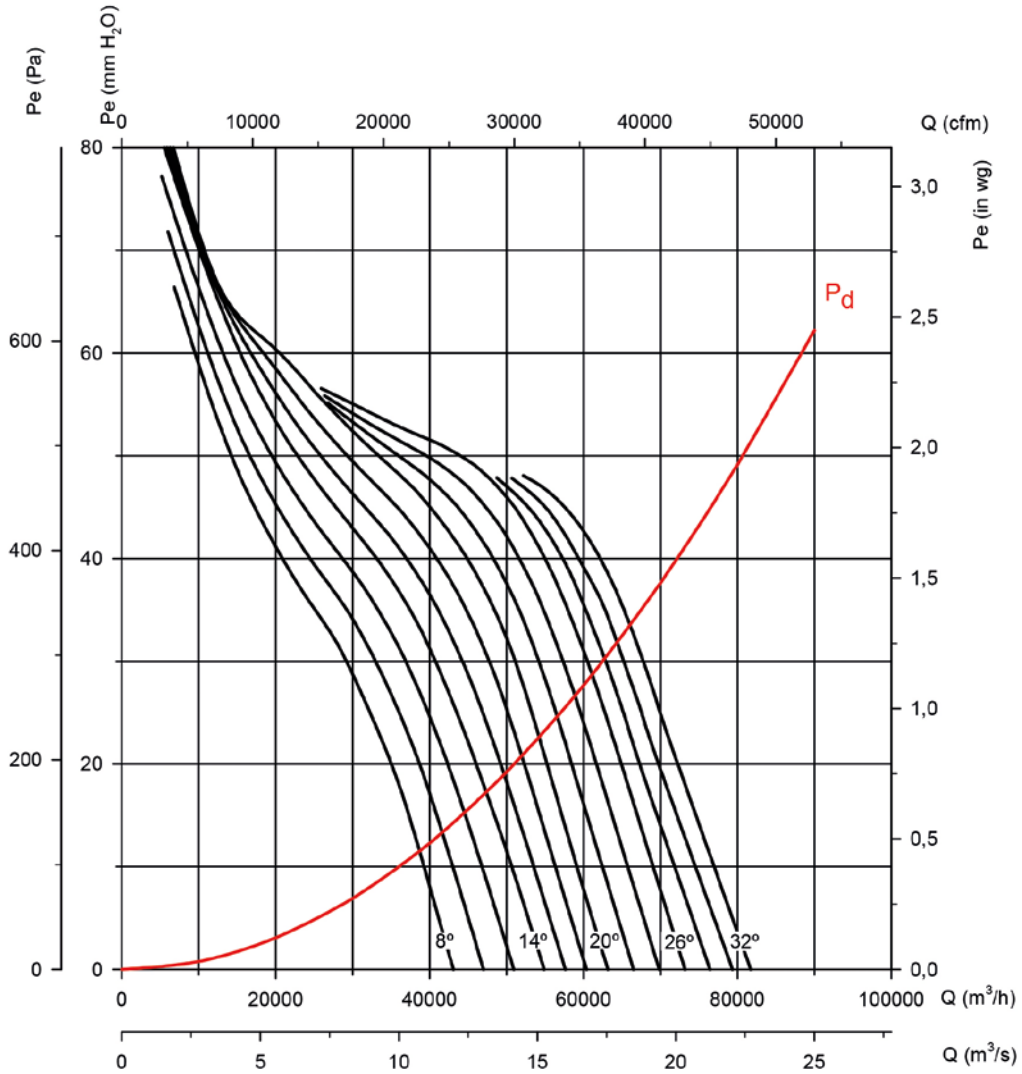

Characteristic curves

Q= Flow rate in m³/h, m³/s and cfm

Pe= Static pressure in mm H₂O, Pa and inwg

Impeller diameter in cm: 100

Number of motor poles: 4

Number of blades: 9

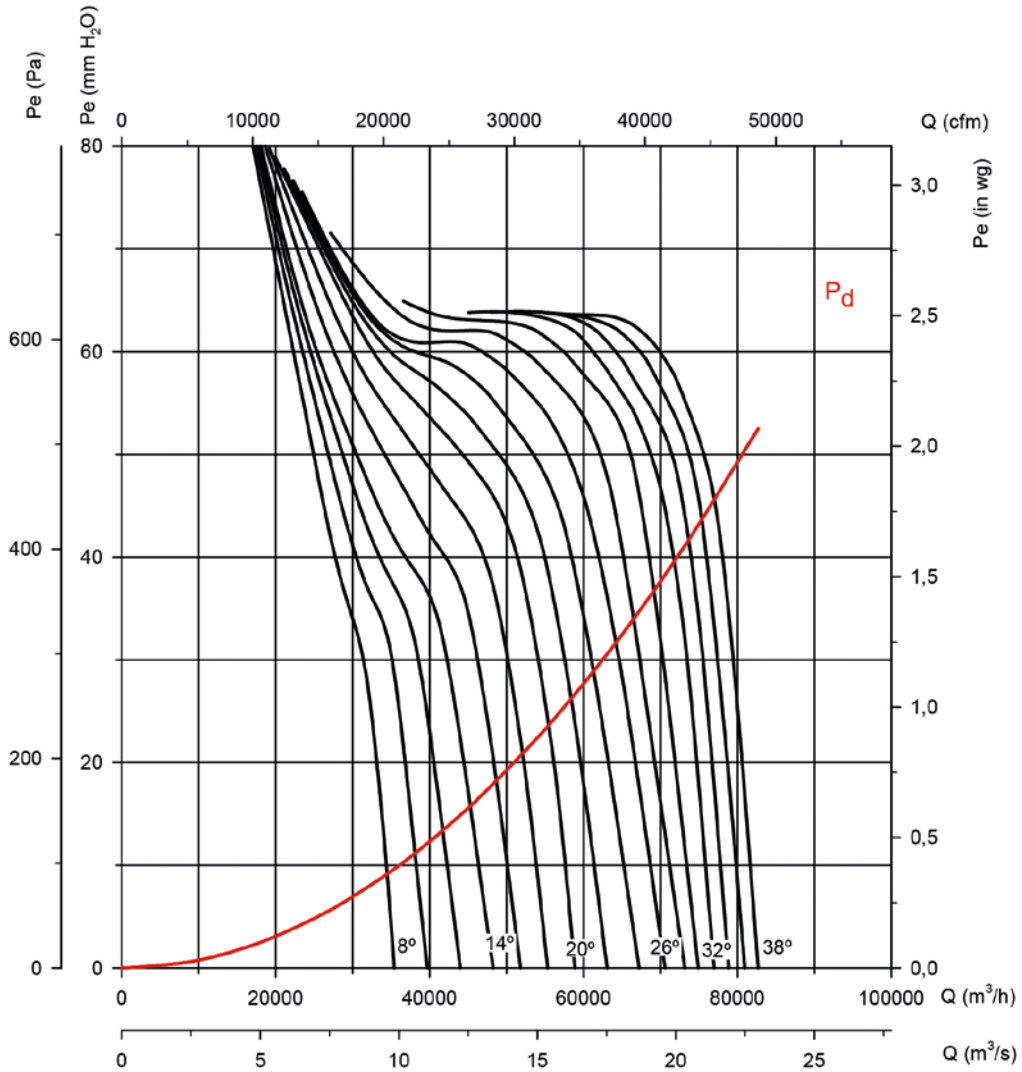

Absorbed power

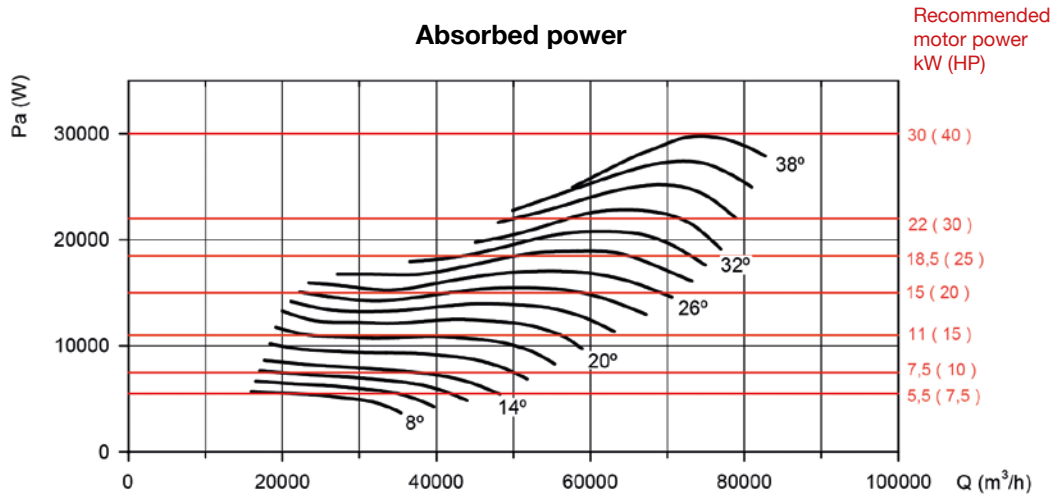

Characteristic curves

Q= Flow rate in m³/h, m³/s and cfm Pe= Static pressure in mm H₂O, Pa and inwg

Impeller diameter in cm: 100

Number of motor poles: 6

Number of blades: 6

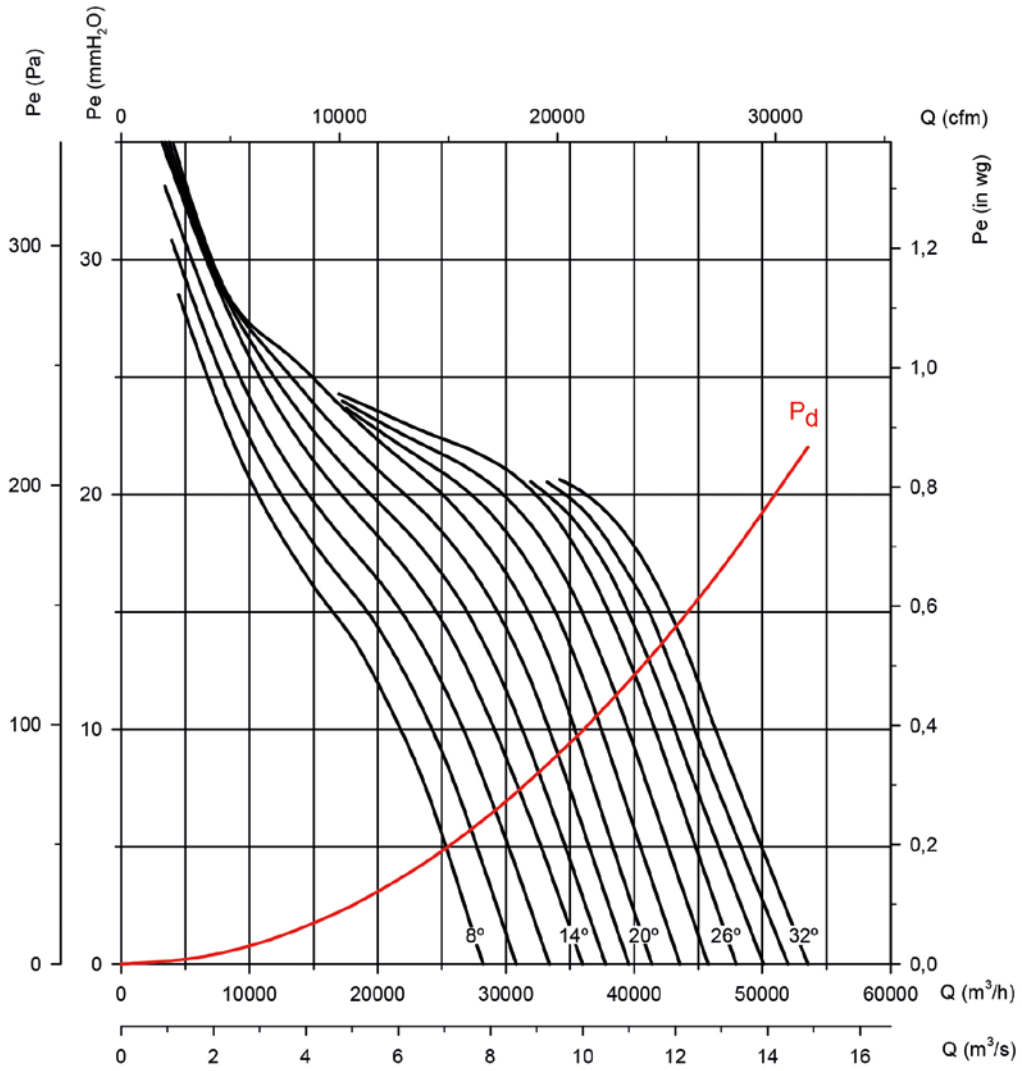

Absorbed power

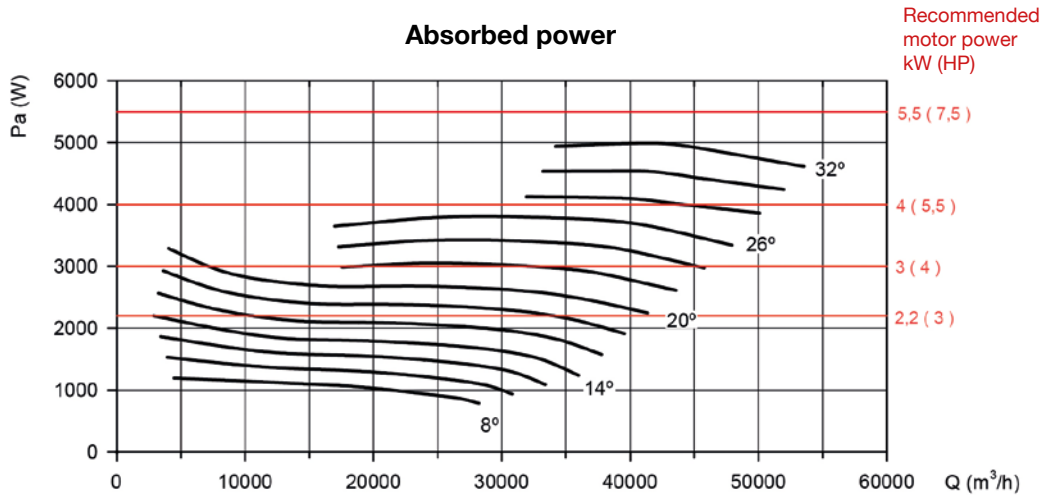

Characteristic curves

Q= Flow rate in m³/h, m³/s and cfm

Pe= Static pressure in mm H₂O, Pa and inwg

Impeller diameter in cm: 100

Number of motor poles: 6

Number of blades: 9

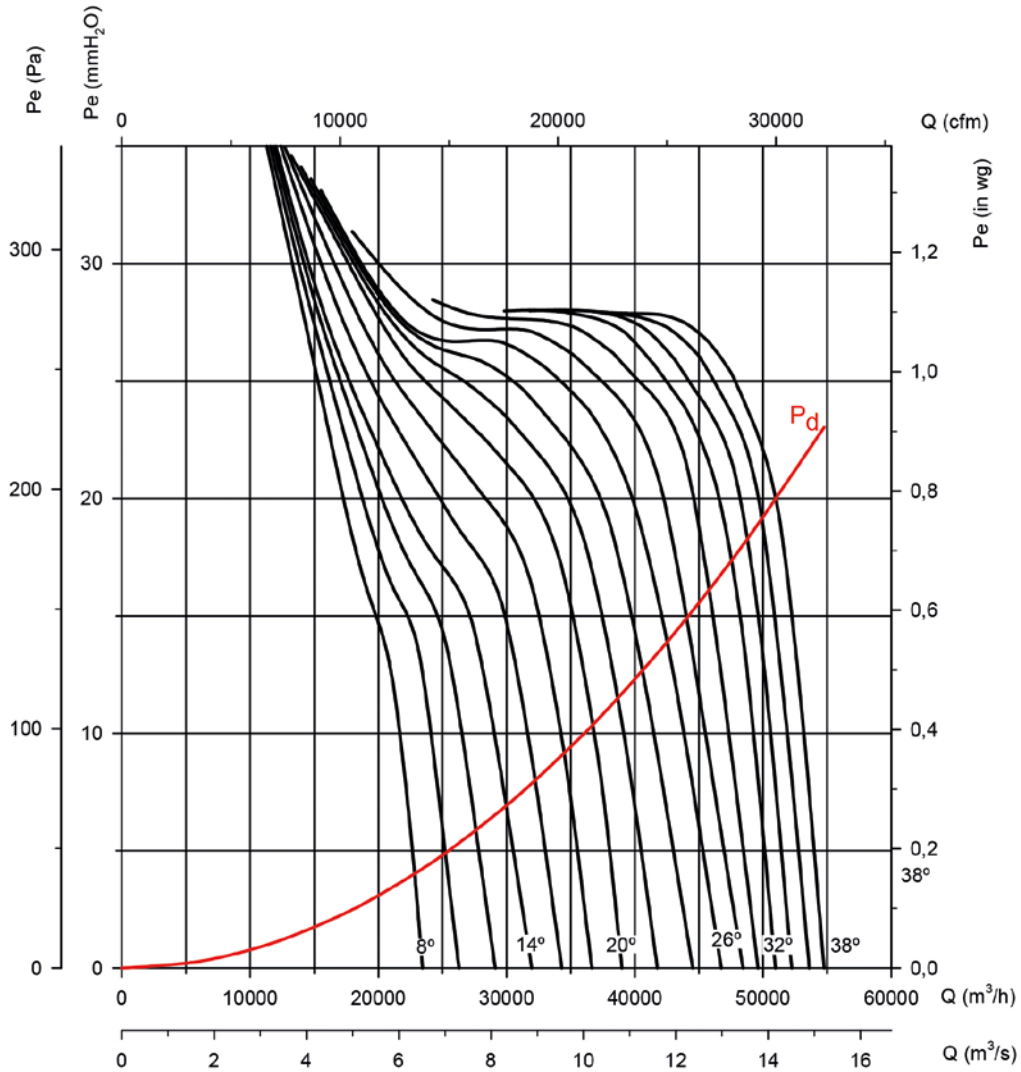

Absorbed power

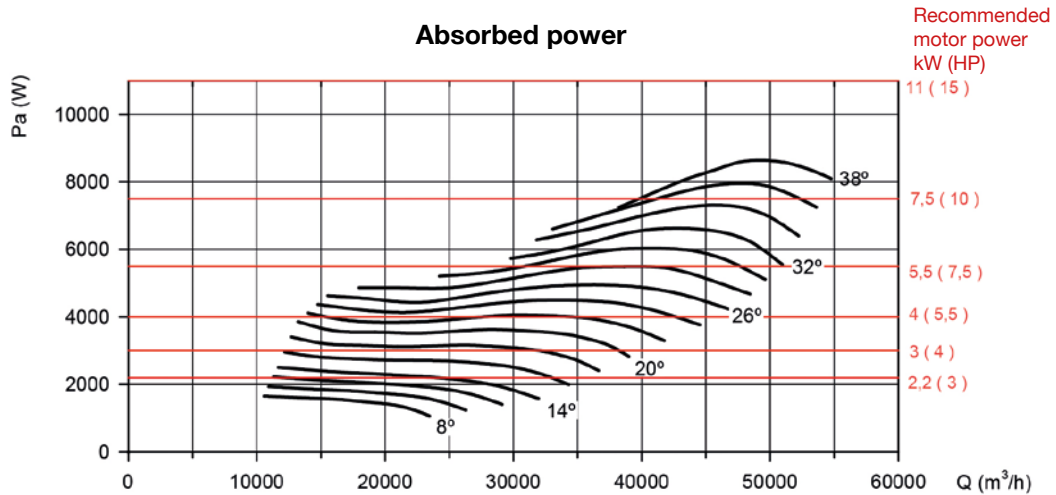

Characteristic curves

Q= Flow rate in m³/h, m³/s and cfm Pe= Static pressure in mm H₂O, Pa and inwg

Impeller diameter in cm: 100

Number of motor poles: 8

Number of blades: 6

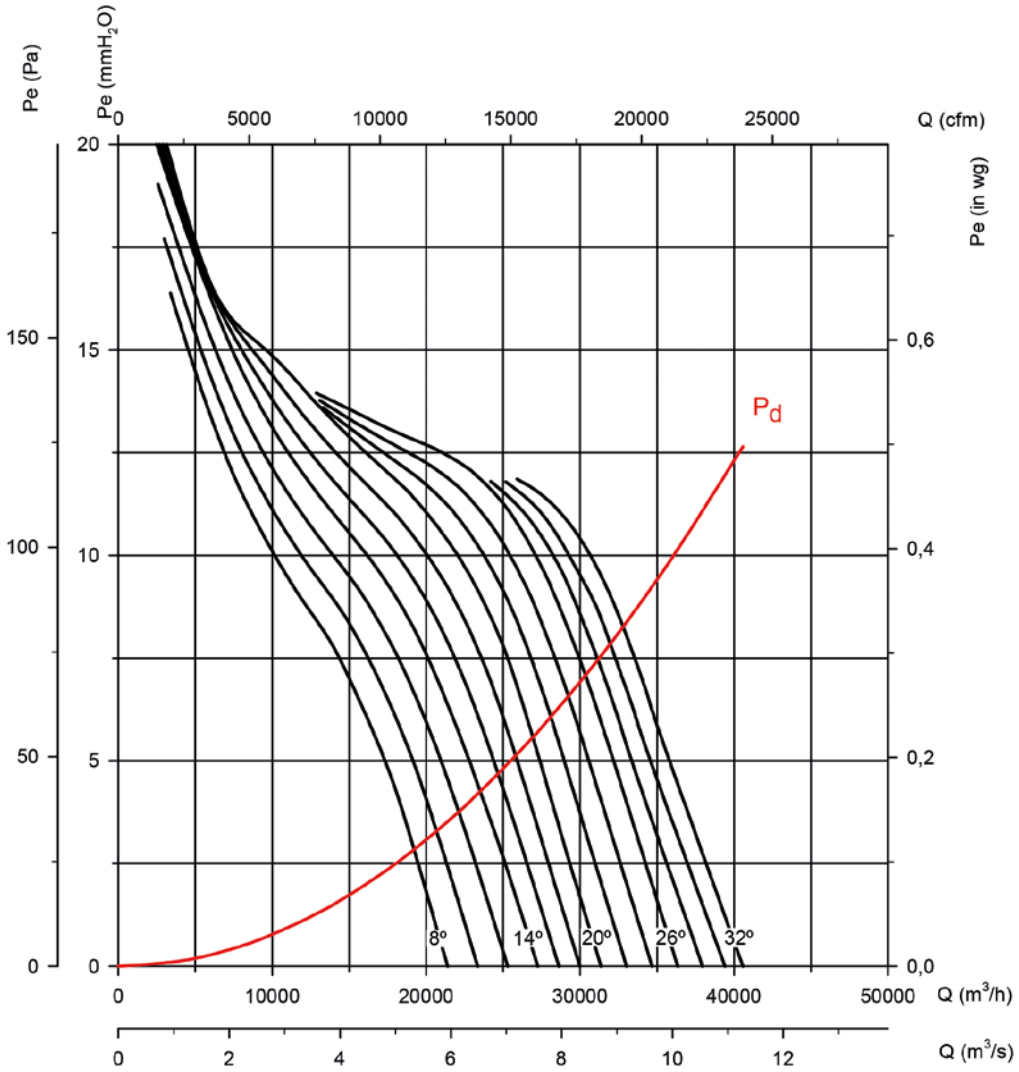

Absorbed power

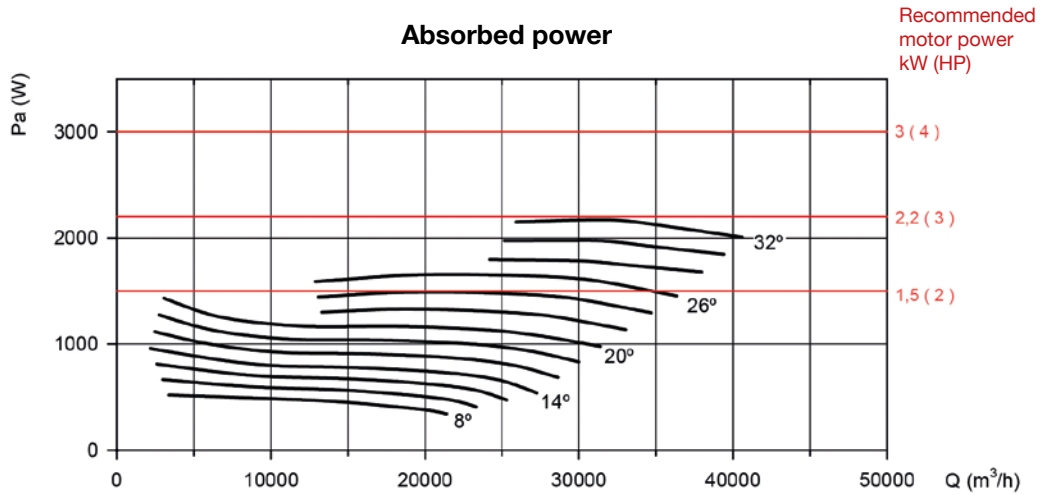

Characteristic curves

Q= Flow rate in m³/h, m³/s and cfm

Pe= Static pressure in mm H₂O, Pa and inwg

Impeller diameter in cm: 125

Number of motor poles: 4

Number of blades: 6

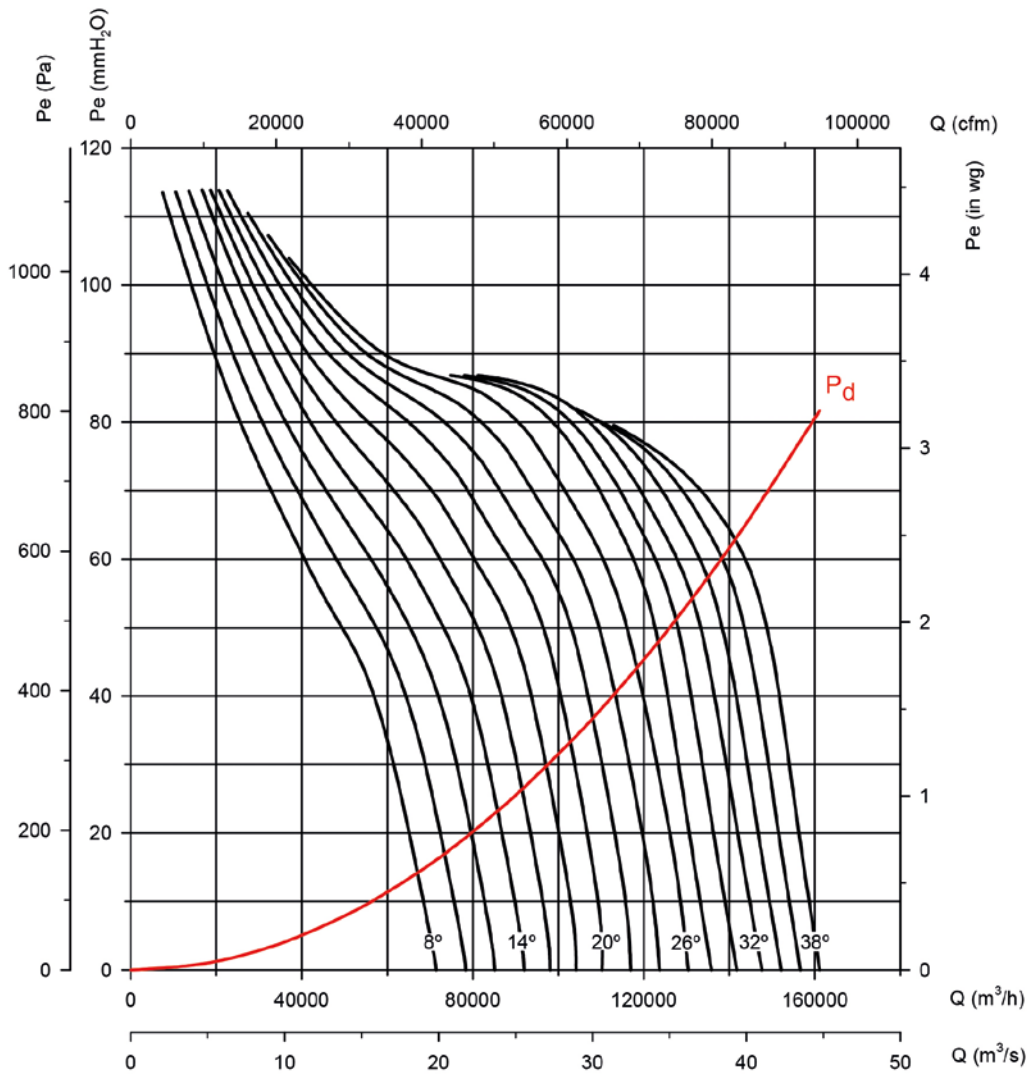

Absorbed power

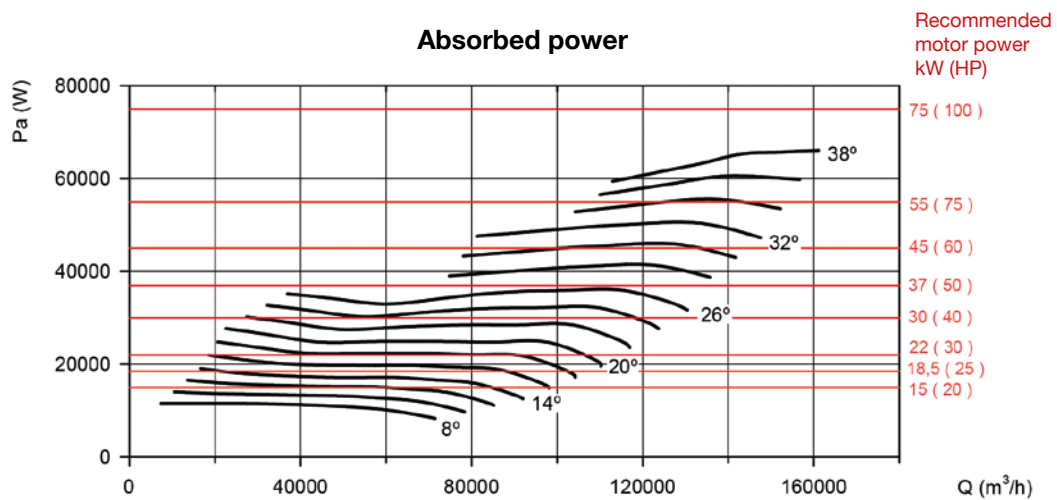

Characteristic curves

Q= Flow rate in m³/h, m³/s and cfm Pe= Static pressure in mm H₂O, Pa and inwg

Impeller diameter in cm: 125

Number of motor poles: 4

Number of blades: 9

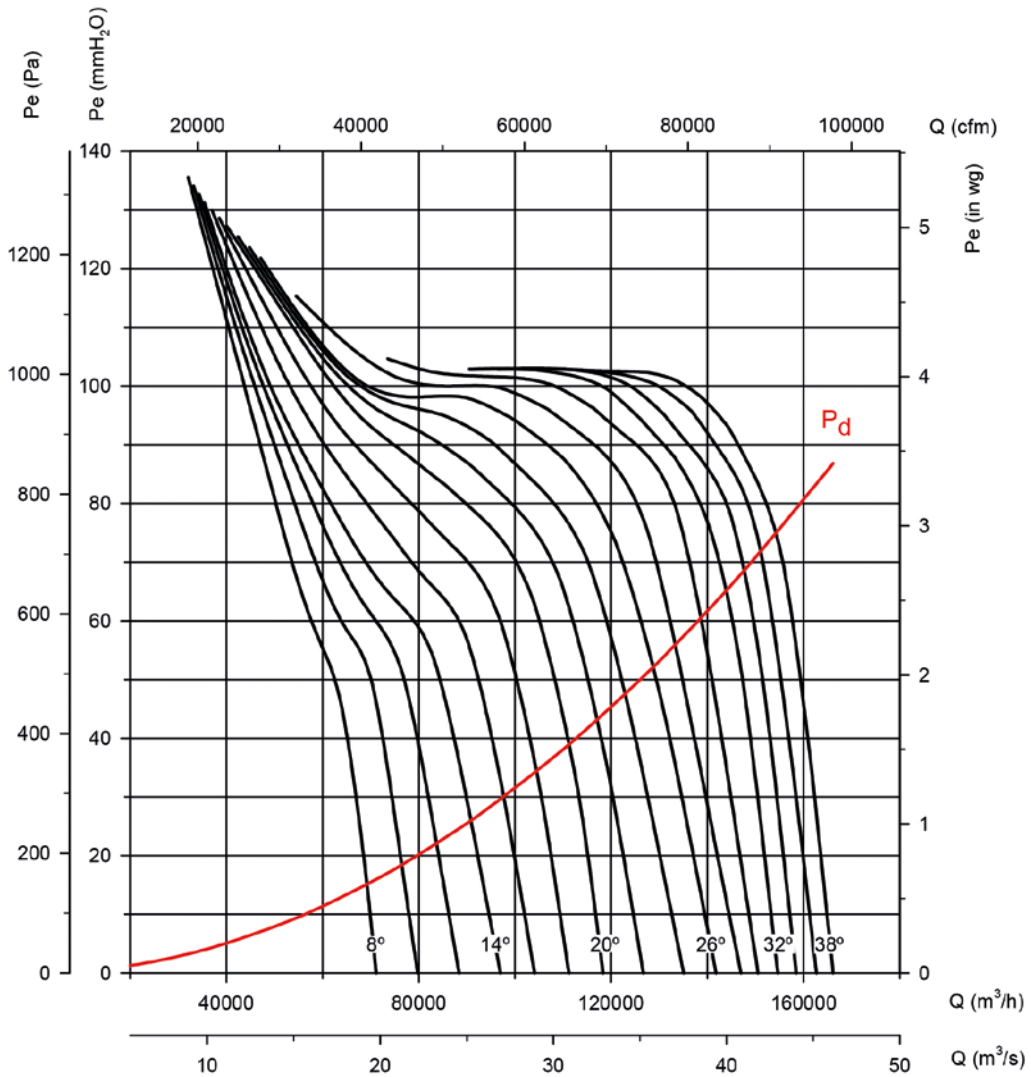

Absorbed power

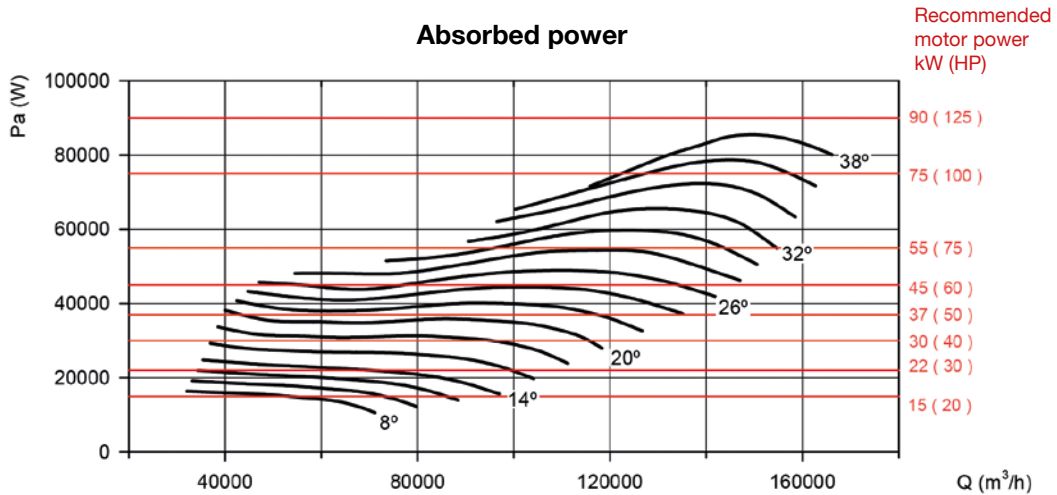

Characteristic curves

Q= Flow rate in m³/h, m³/s and cfm Pe= Static pressure in mm H₂O, Pa and inwg

Impeller diameter in cm: 125

Number of motor poles: 4

Number of blades: 12

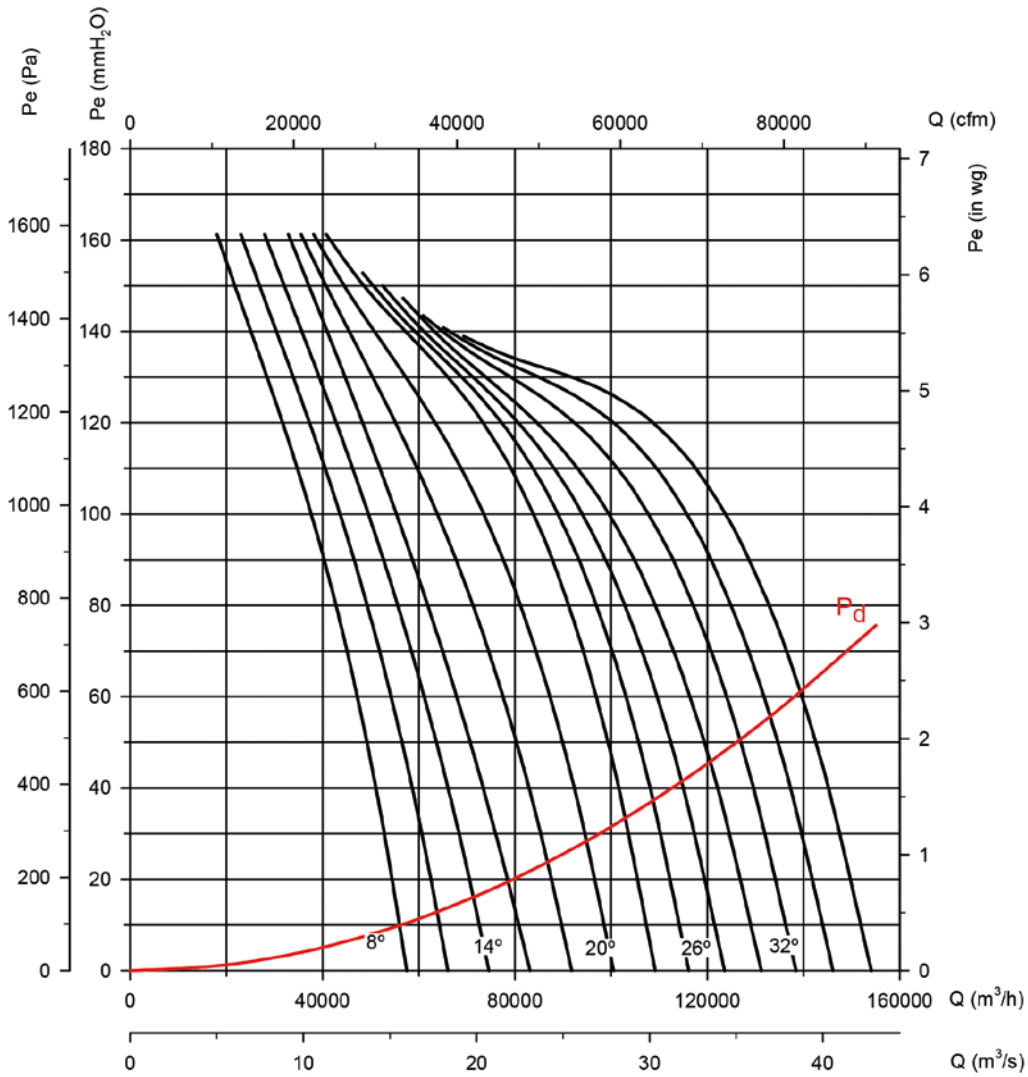

Absorbed power

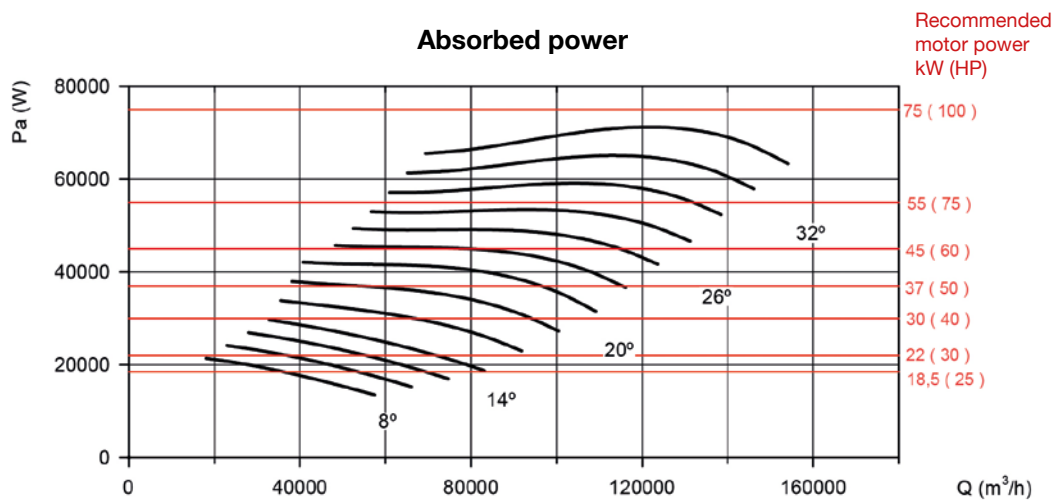

Characteristic curves

Q= Flow rate in m³/h, m³/s and cfm Pe= Static pressure in mm H₂O, Pa and inwg

Impeller diameter in cm: 125

Number of motor poles: 6

Number of blades: 6

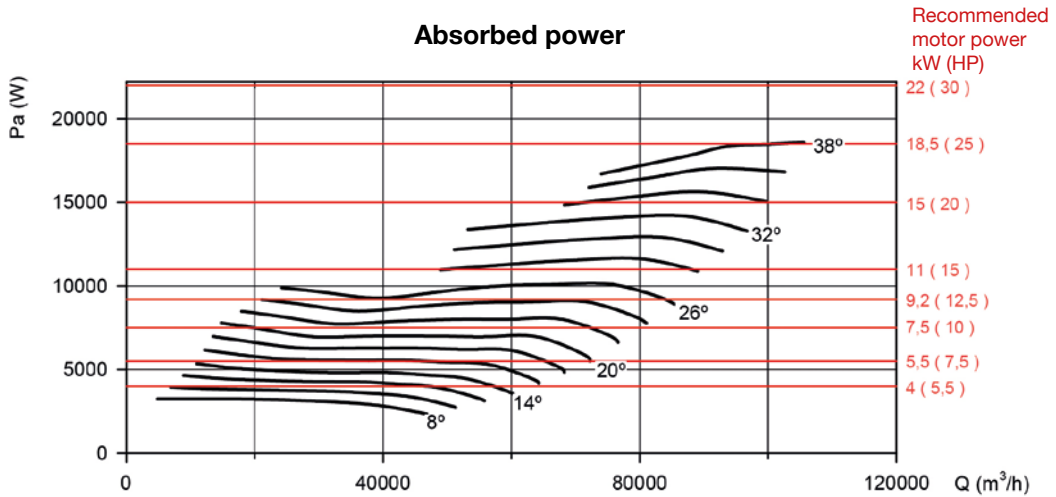
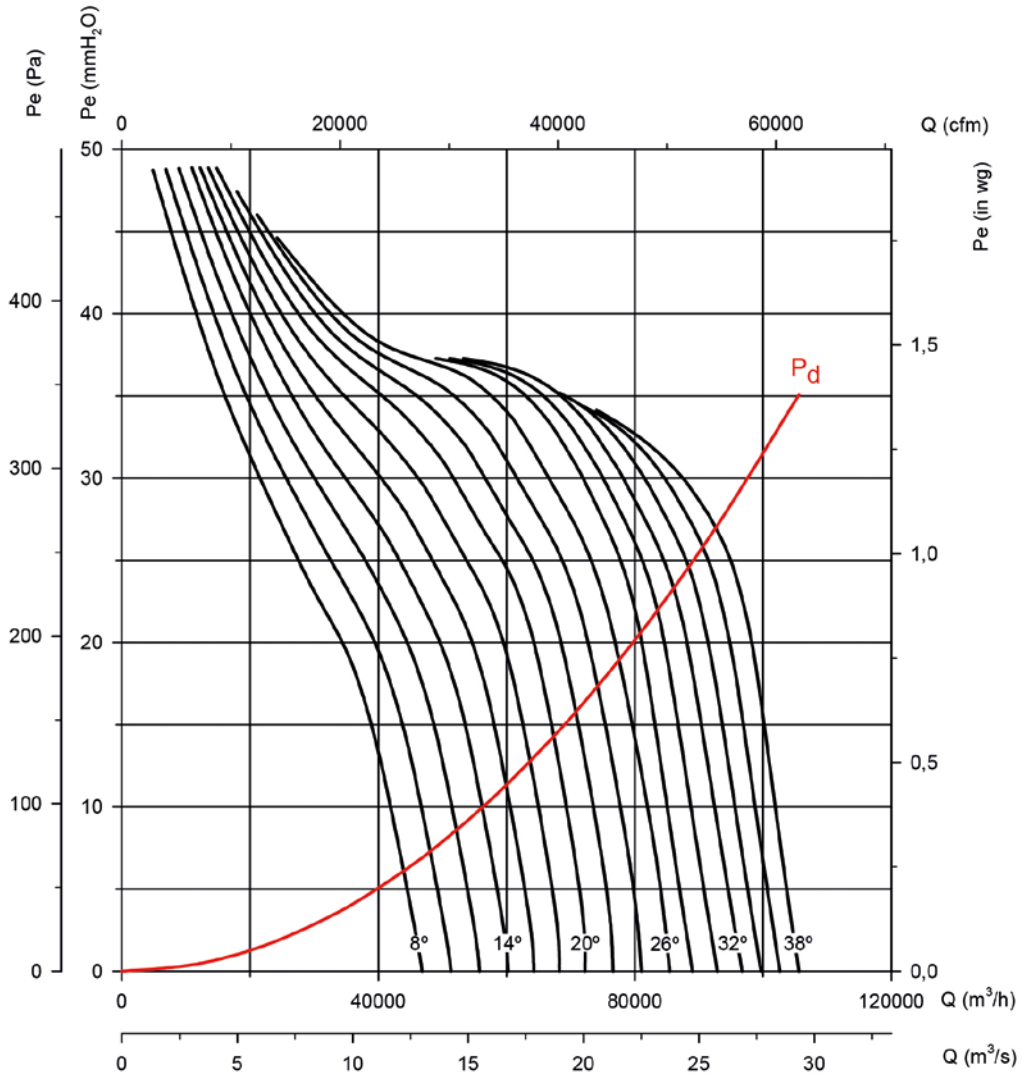

Characteristic curves

Q= Flow rate in m³/h, m³/s and cfm

Pe= Static pressure in mm H₂O, Pa and inwg

Impeller diameter in cm: 125

Number of motor poles: 6

Number of blades: 9

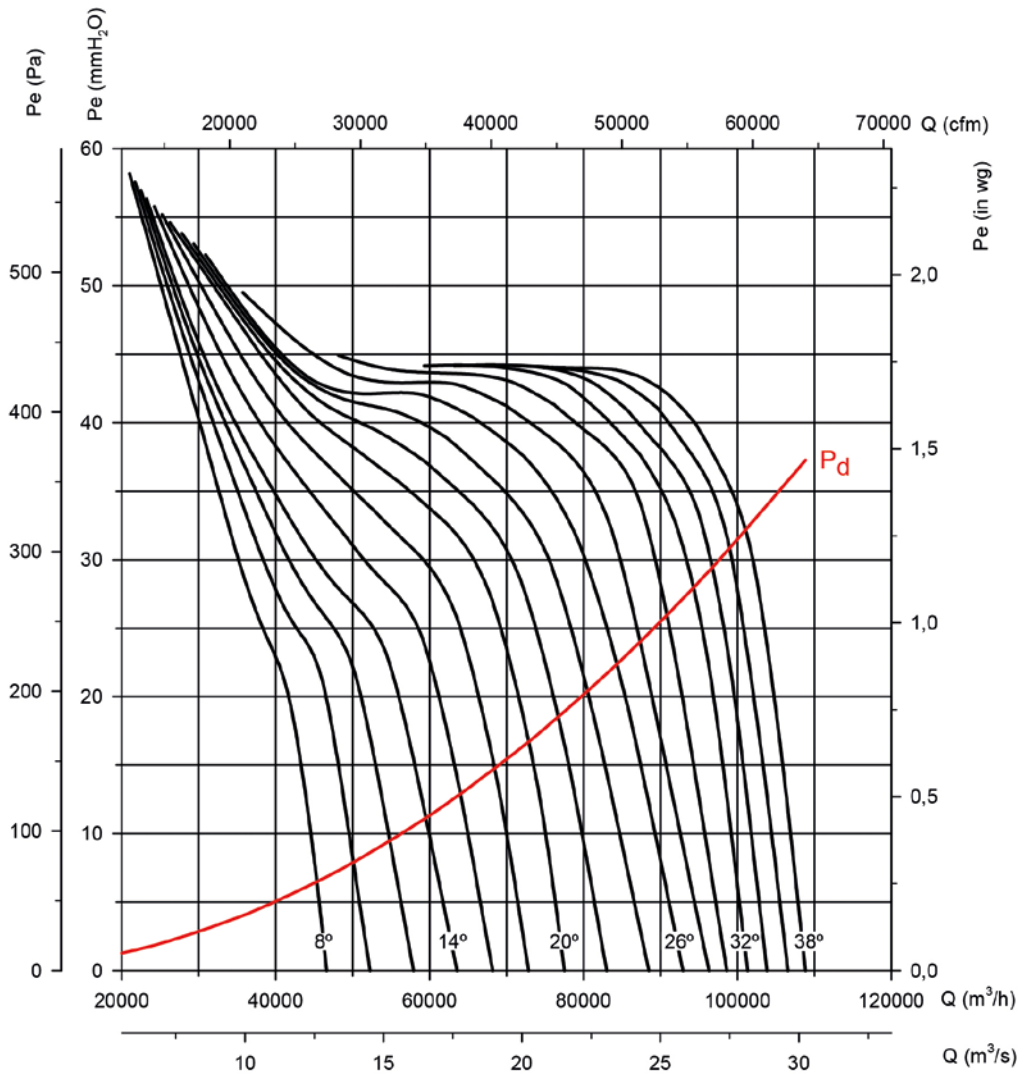

Absorbed power

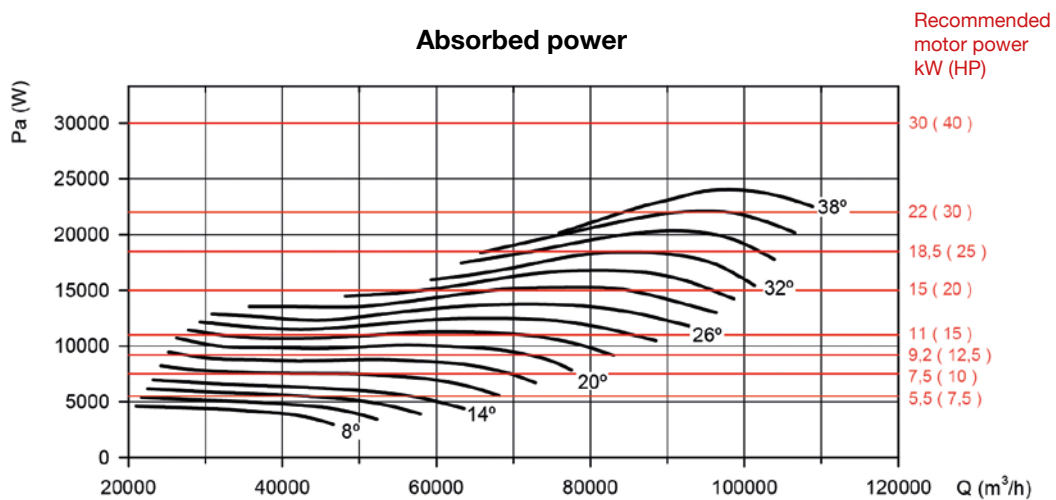

Characteristic curves

Q= Flow rate in m³/h, m³/s and cfm Pe= Static pressure in mm H₂O, Pa and inwg

Impeller diameter in cm: 125

Number of motor poles: 6

Number of blades: 12

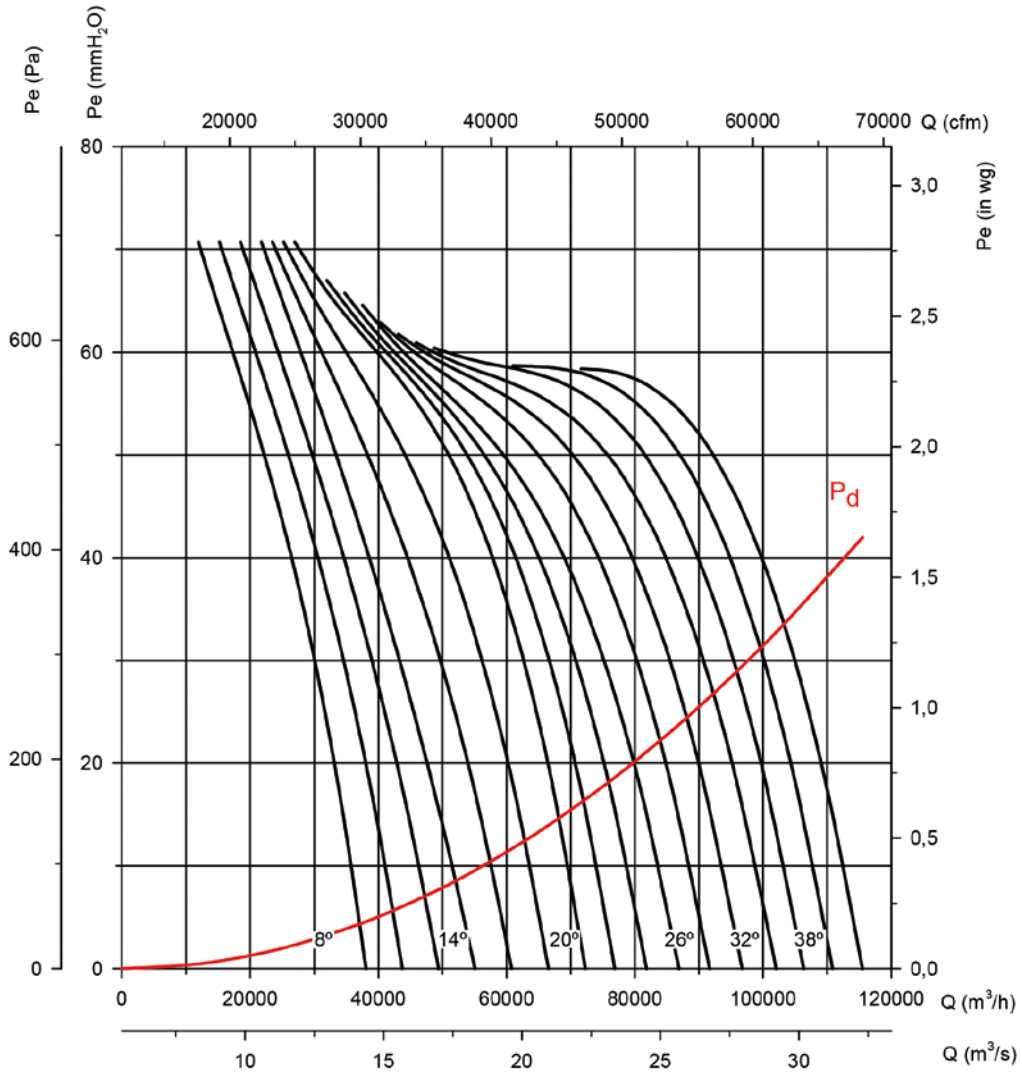

Absorbed power

Recommended motor power kW (HP)

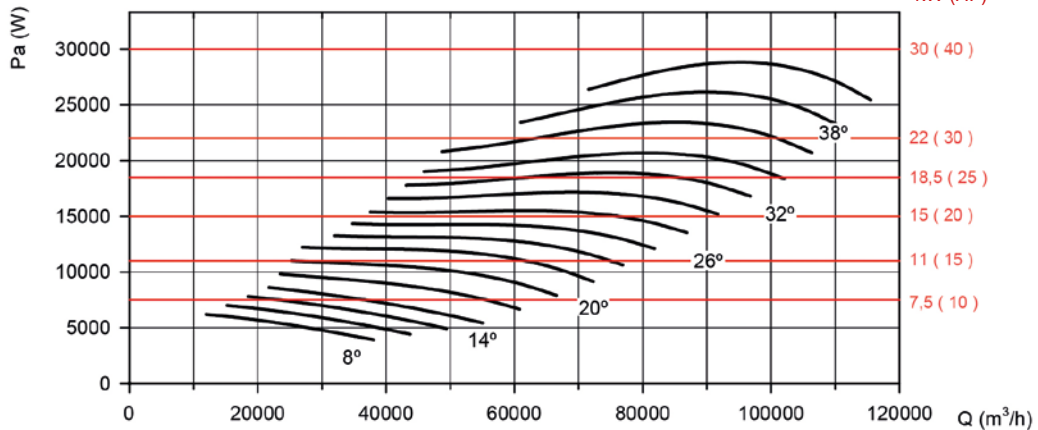

Characteristic curves

Q= Flow rate in m³/h, m³/s and cfm Pe= Static pressure in mm H₂O, Pa and inwg

Impeller diameter in cm: 140

Number of motor poles: 6

Number of blades: 6

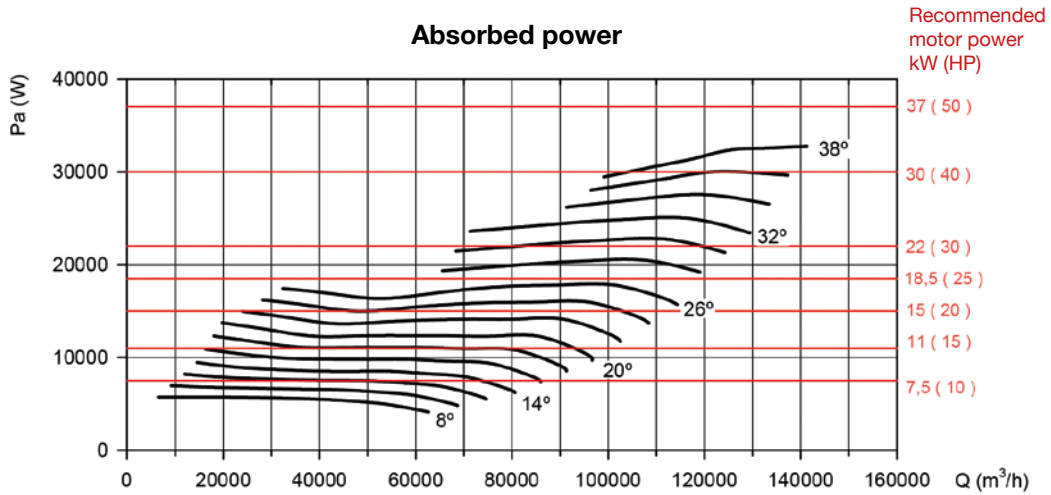
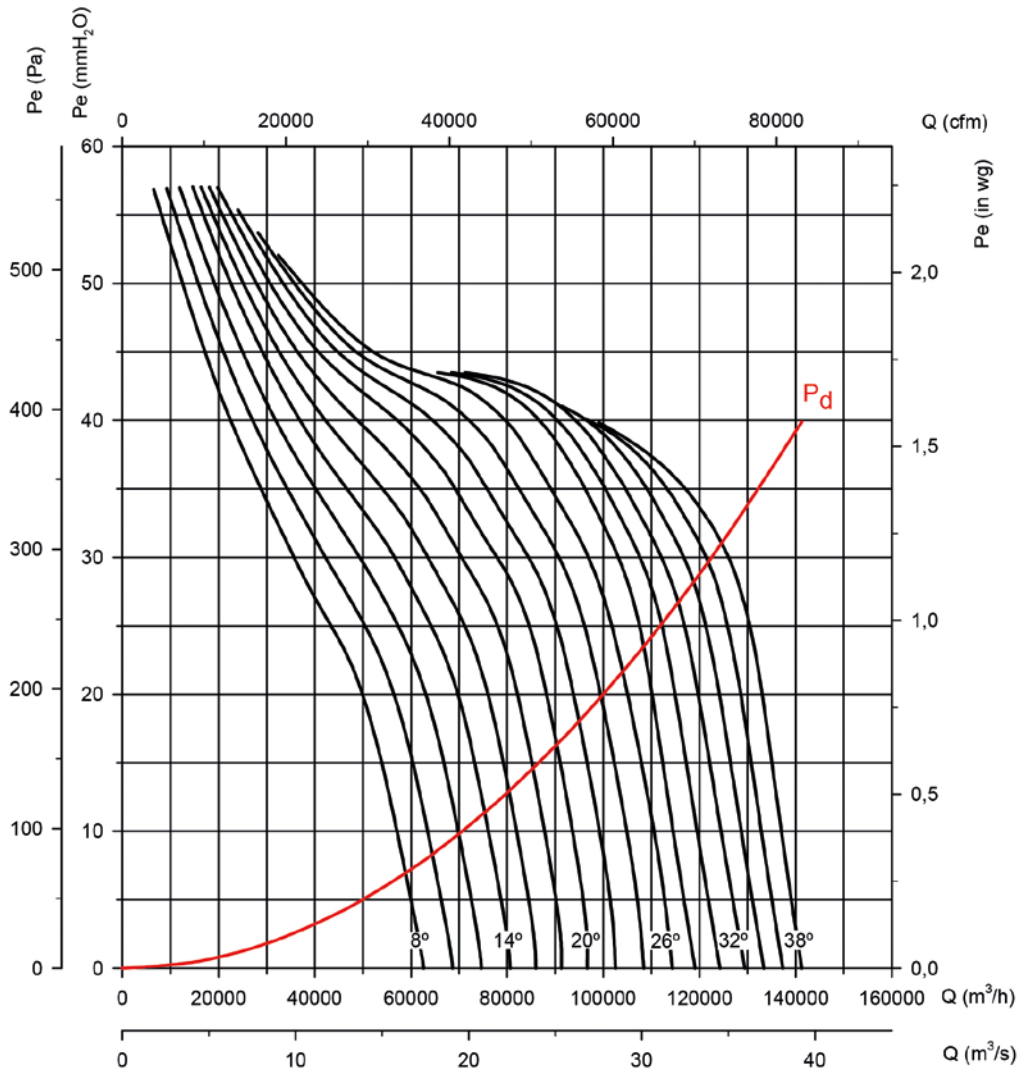

Characteristic curves

Q= Flow rate in m³/h, m³/s and cfm Pe= Static pressure in mm H₂O, Pa and inwg

Impeller diameter in cm: 140

Number of motor poles: 6

Number of blades: 9

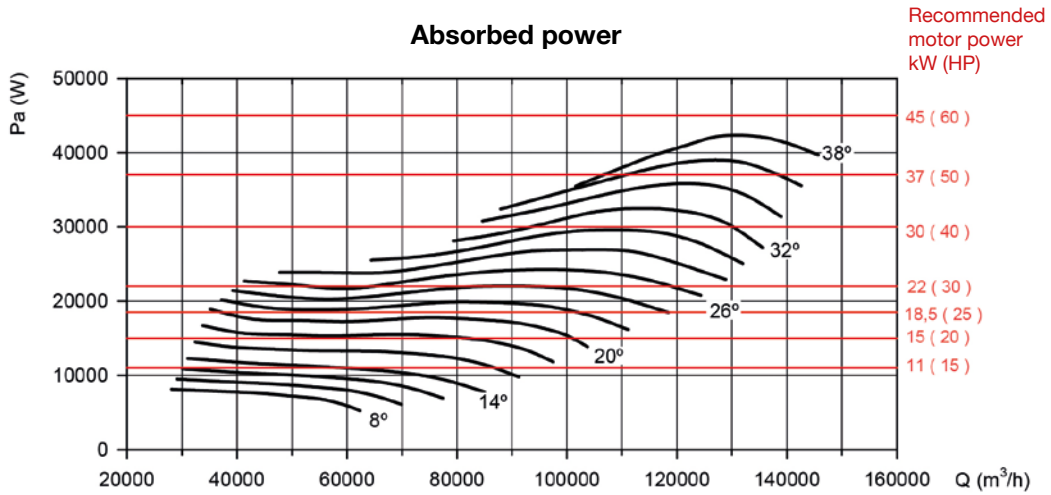
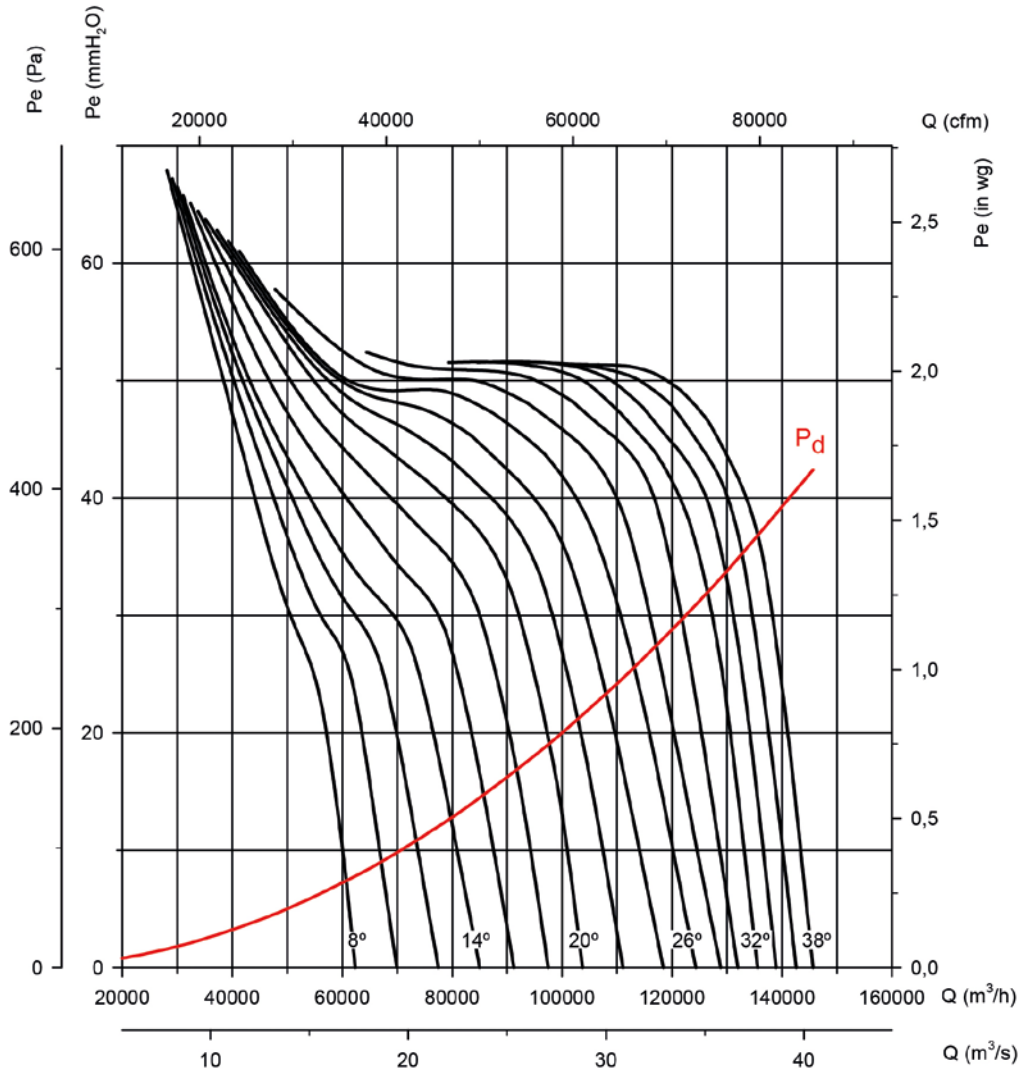

Characteristic curves

Q= Flow rate in m³/h, m³/s and cfm

Pe= Static pressure in mm H₂O, Pa and inwg

Impeller diameter in cm: 140

Number of motor poles: 6

Number of blades: 12

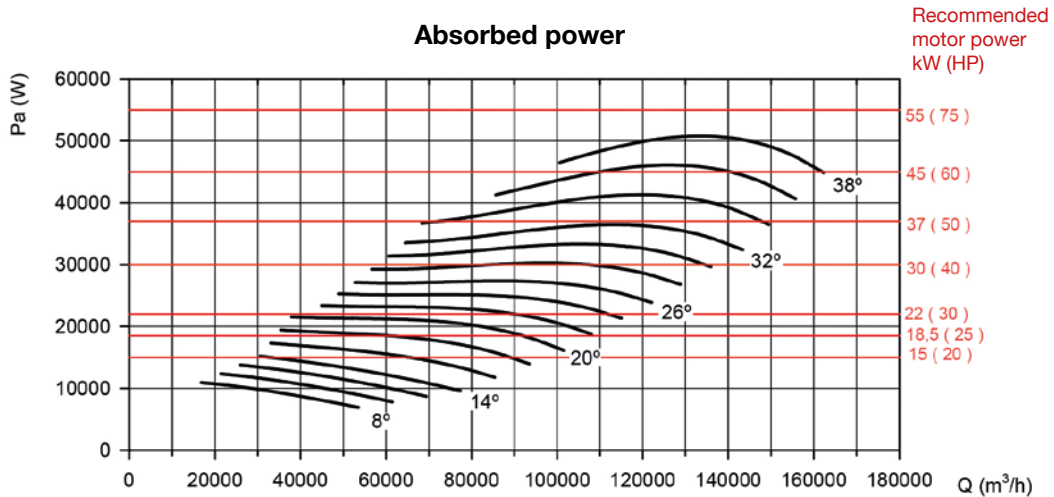
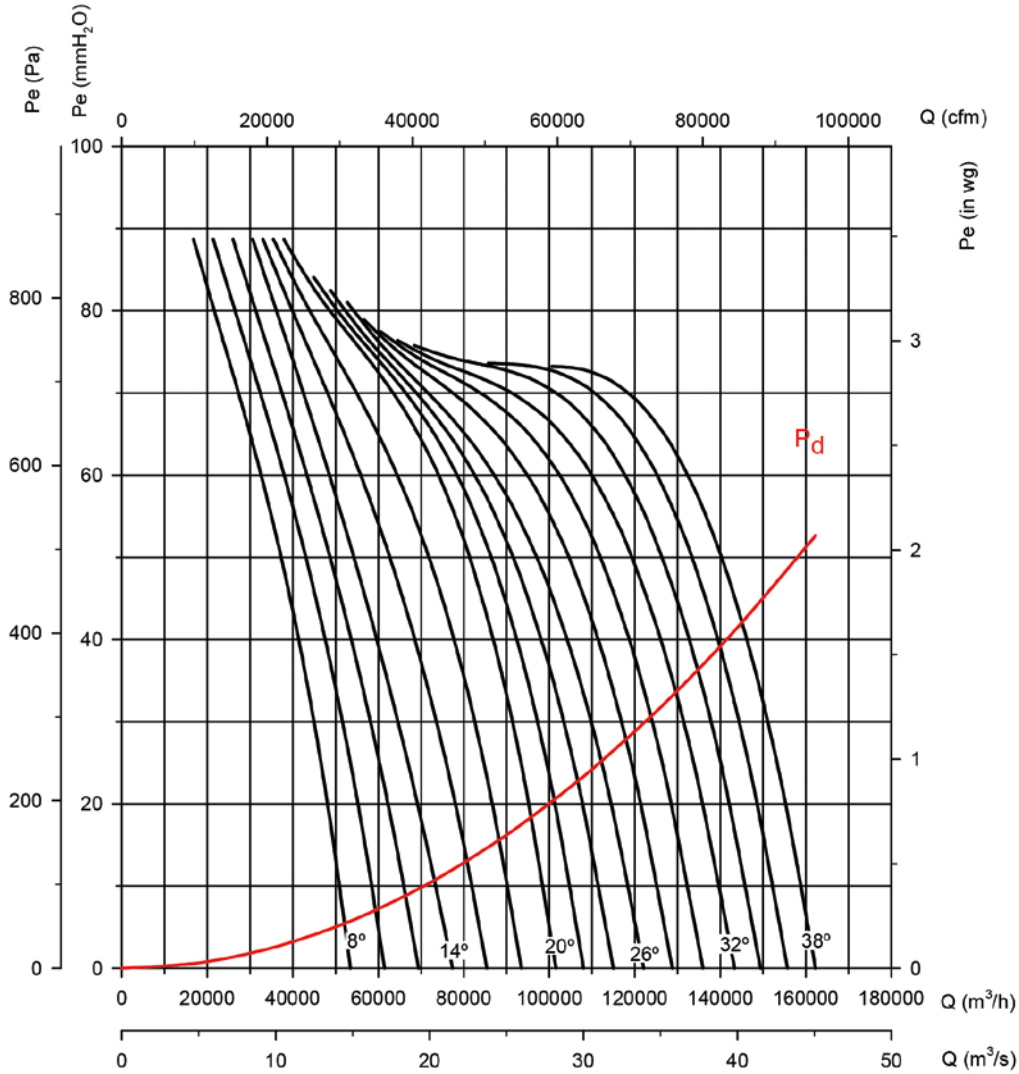

Characteristic curves

Q= Flow rate in m³/h, m³/s and cfm

Pe= Static pressure in mm H₂O, Pa and inwg

Impeller diameter in cm: 160

Number of motor poles: 6

Number of blades: 6

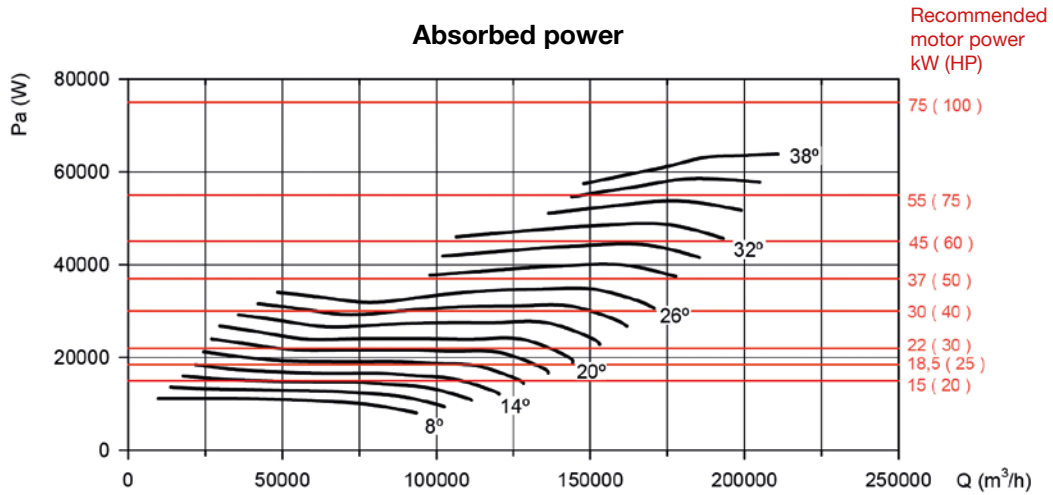
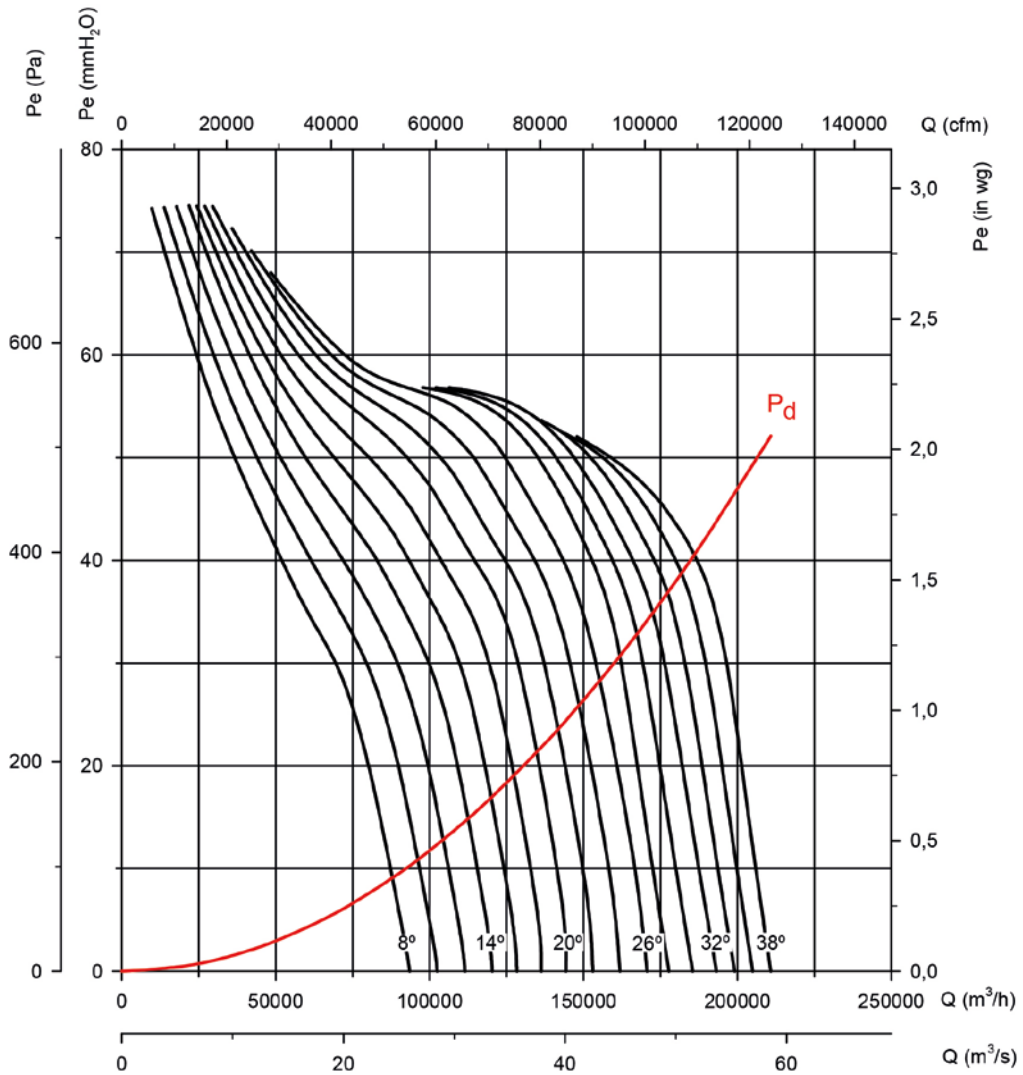

Characteristic curves

Q= Flow rate in m³/h, m³/s and cfm Pe= Static pressure in mm H₂O, Pa and inwg

Impeller diameter in cm: 160

Number of motor poles: 6

Number of blades: 9

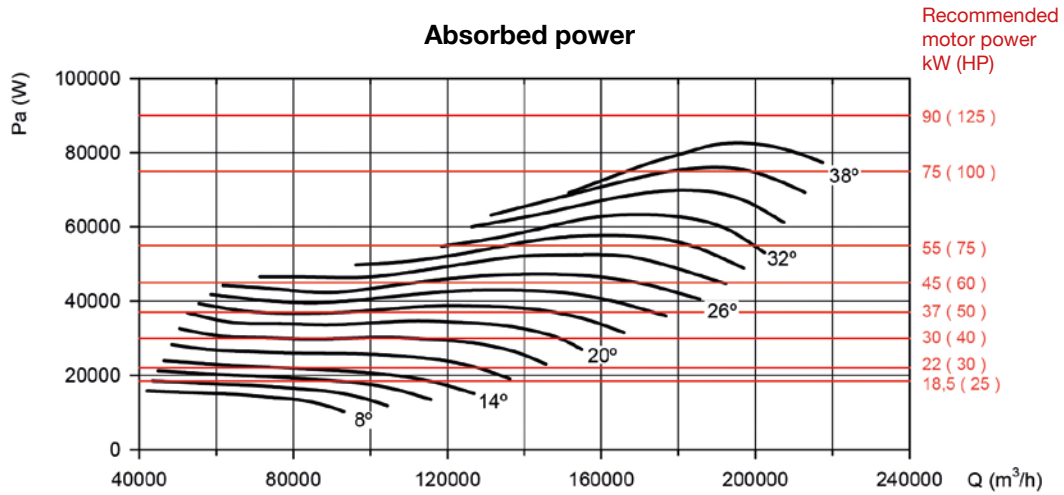
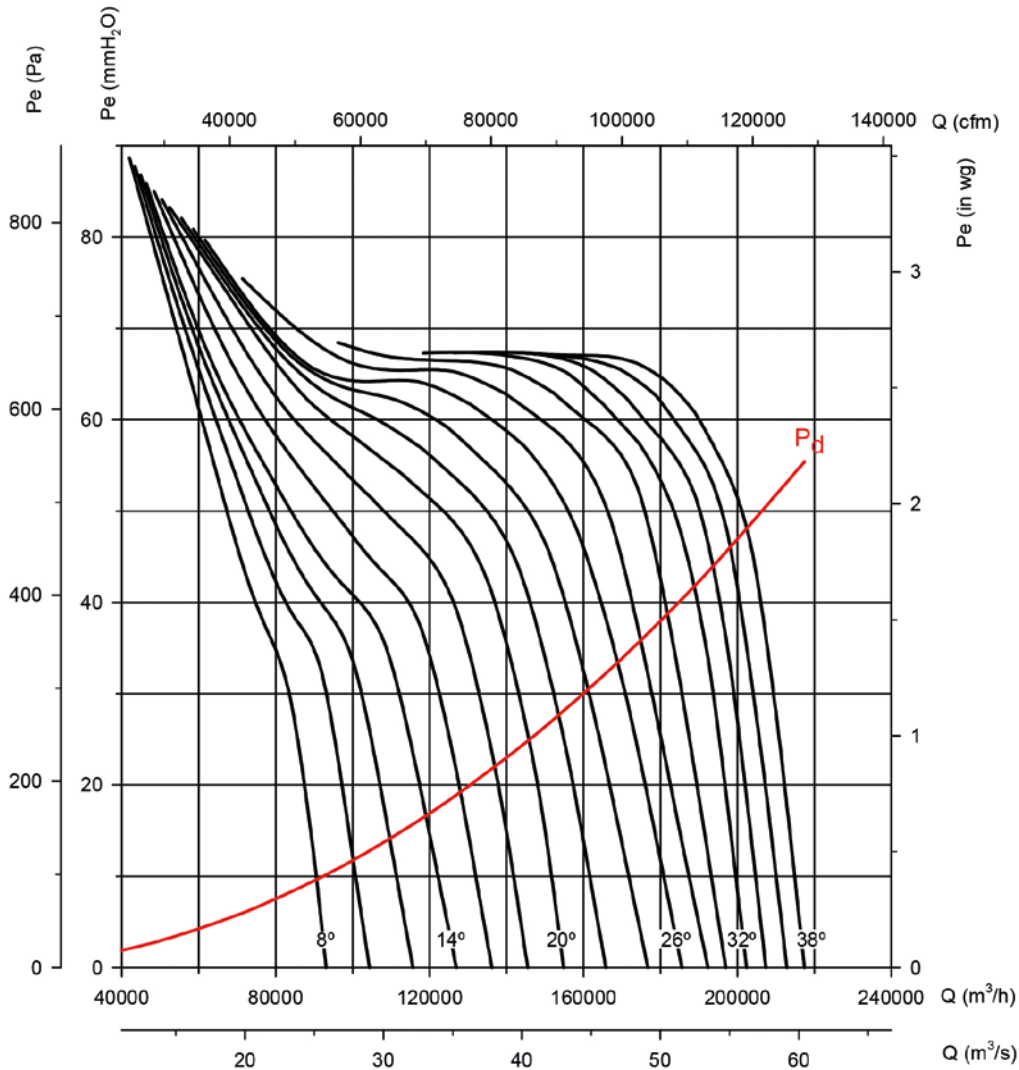

Characteristic curves

Q= Flow rate in m³/h, m³/s and cfm Pe= Static pressure in mm H₂O, Pa and inwg

Impeller diameter in cm: 160

Number of motor poles: 6

Number of blades: 12

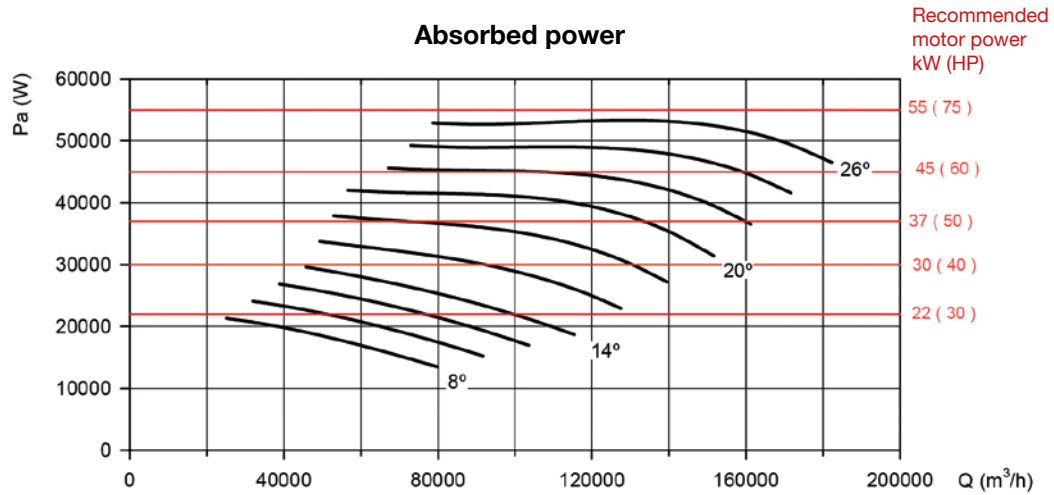
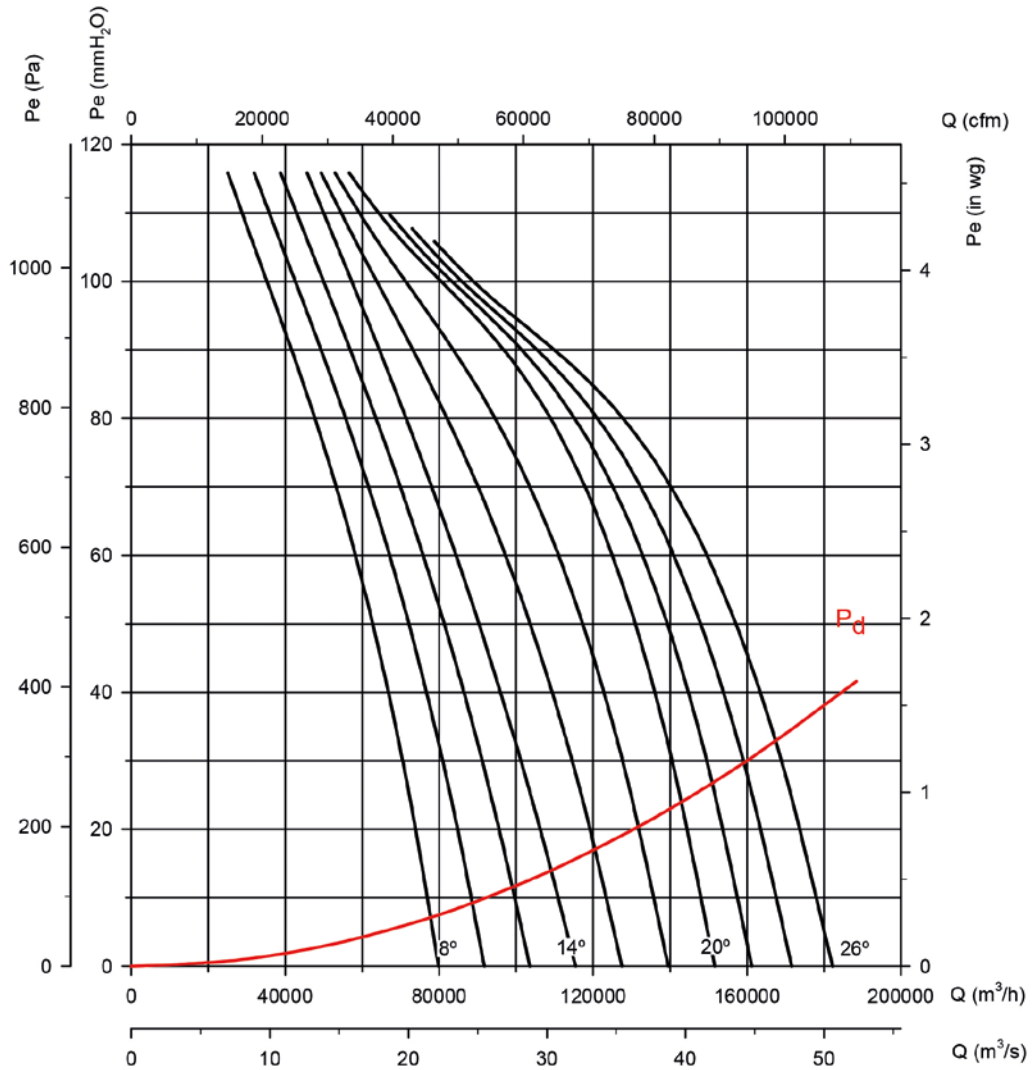

THT/CL

400 °C/2h and 300 °C/2h tubular axial extractor fans with long casing and external terminal boxes



Tubular axial extract fans with long casing for immersed operation in fire risk zones.

Fan:

- Tubular casing in sheet steel with external terminal box (Cable box) and inspection hatch.
- Variable angle impeller made of cast aluminium.
- Approved in accordance with standard EN 12101-3, with certifications no.: 0370-CPR-0305 (F400) and 0370-CPR-0973 (F300).
- Airflow direction from motor to impeller.

Motor:

- Class H motors for S1 continuous operation and S2 emergency use. With ball bearings, IP55 protection and 1 or 2 speeds, depending on model.
- Motors with IE3 efficiency for powers equal to or greater than 0.75 kW, except single-phase, 2-speed and 8-pole.
- Three-phase 230/400 V 50 Hz (up to 3 kW) and 400/690 V 50 Hz (powers greater than 3 kW).

- Maximum temperature of air to be carried: S1 -20 °C +40 °C continuous service, also suitable for warm climates with temperatures up to 50 °C. S2 operation, 300 °C/2h, 400 °C/2h.

Finish:

- Anti-corrosive finish in polyester resin, polymerised at 190 °C, after degreasing with phosphate-free nanotechnology treatment.

Available versions:

- THT: tubular axial fans with short casing.

On request:

- Airflow direction from impeller to motor.
- 100% reversible impellers.

Order code

From size 40 to size 100

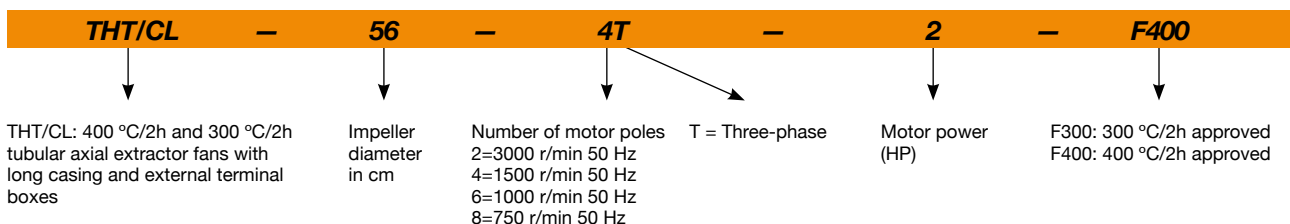

From size 125 to size 160

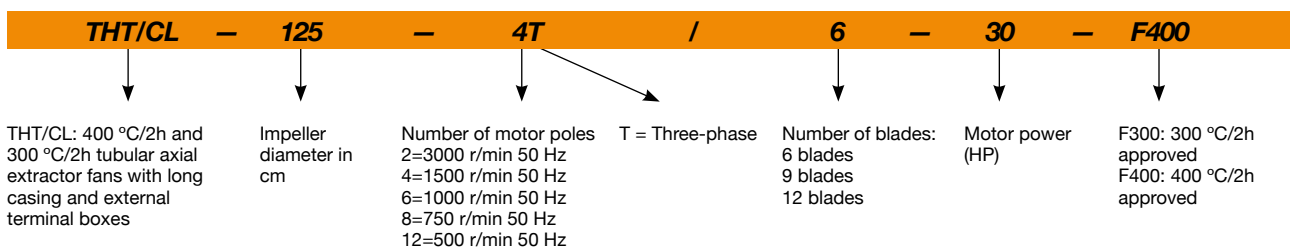

Technical characteristics

Model	Speed (r/min)	Maximum admissible current (A)			Installed power (kW)	Blade tilt angle (°)	Maximum flow rate (m³/h)	Sound pressure level¹ dB (A) Inlet	Approx. weight (Kg)
		230V	400V	690V					
THT/CL-40-2T-1.5 IE3	2880	3.93	2.26		1.10	20	7040	71	33
THT/CL-40-2/4T-1.5	2900 / 1435		2.89 / 1.04		1.10 / 0.25	20	7040 / 3480	71 / 56	34
THT/CL-40-2/4T-2	2940 / 1465		3.58 / 1.19		1.50 / 0.37	24	7950 / 3950	71 / 56	35
THT/CL-40-4T-0.75	1420	2.84	1.64		0.55	32	4800	55	32
THT/CL-40-6T-0.75	930	2.90	1.75		0.55	32	3150	46	37
THT/CL-40-6/12T-0.75	940 / 455		2.35 / 1.15		0.60 / 0.15	32	3150 / 1520	46 / 31	41
THT/CL-45-2T-2 IE3	2880	4.91	2.84		1.50	16	9400	71	38
THT/CL-45-2/4T-2	2940 / 1465		3.58 / 1.19		1.50 / 0.37	16	9400 / 4680	71 / 56	37
THT/CL-45-2T-3 IE3	2900	7.14	4.13		2.20	22	11330	71	39
THT/CL-45-2/4T-3	2930 / 1460		4.79 / 1.54		2.20 / 0.60	22	11330 / 5640	71 / 56	39
THT/CL-45-2T-4 IE3	2855	9.61	5.52		3.00	28	13074	72	49
THT/CL-45-4T-0.75	1420	2.84	1.64		0.55	36	7450	58	34
THT/CL-45-6T-0.75	930	2.90	1.75		0.55	30	4450	48	38
THT/CL-45-6/12T-0.75	940 / 455		2.35 / 1.15		0.60 / 0.15	30	4450 / 2150	48 / 33	42
THT/CL-50-2T-3 IE3	2860	7.14	4.13		2.20	12	11948	76	46
THT/CL-50-2/4T-4	2920 / 1445		6.70 / 2.09		3.00 / 0.80	16	13880 / 6870	76 / 61	51
THT/CL-50-2/4T-6	2930 / 1455		9.50 / 2.80		4.50 / 1.30	20	15900 / 7880	76 / 61	67
THT/CL-50-4T-0.75	1420	2.84	1.64		0.55	22	8390	60	35
THT/CL-50-6T-0.75	930	2.90	1.75		0.55	32	7000	52	40
THT/CL-56-2T-5.5 IE3	2890		7.20	4.17	4.00	16	18800	78	69
THT/CL-56-2/4T-6	2930 / 1455		9.50 / 2.80		4.50 / 1.30	16	18800 / 9320	78 / 63	71
THT/CL-56-2/4T-12	2920 / 1440		18.30 / 5.90		9.00 / 2.50	30	27200 / 13390	79 / 64	137
THT/CL-56-4T-1 IE3	1430	3.08	1.79		0.75	22	11250	63	45
THT/CL-56-4T-1.5 IE3	1440	4.10	2.37		1.10	30	13600	63	44
THT/CL-56-4/8T-1.5	1440 / 705		2.69 / 1.12		1.10 / 0.25	30	13600 / 6640	63 / 48	48
THT/CL-56-4T-2 IE3	1415	5.89	3.38		1.50	36	15030	64	48
THT/CL-56-6T-0.75	930	2.90	1.75		0.55	38	10140	54	44
THT/CL-56-6/12T-0.75	940 / 455		2.35 / 1.15		0.60 / 0.15	38	10140 / 4890	54 / 39	48
THT/CL-63-2T-12 IE3	2950		18.07	10.44	9.20	18	32300	83	161
THT/CL-63-2T-20 IE3	2960		26.50	15.35	15.00	28	39950	82	188
THT/CL-63-4T-1 IE3	1430	3.08	1.79		0.75	14	15190	67	49
THT/CL-63-4T-1.5 IE3	1420	4.10	2.37		1.10	20	17800	66	51
THT/CL-63-4/8T-1.5	1440 / 705		2.69 / 1.12		1.10 / 0.25	20	17800 / 8680	66 / 51	55
THT/CL-63-4T-2 IE3	1425	5.89	3.38		1.50	24	19280	66	55
THT/CL-63-4/8T-2	1415 / 715		3.40 / 1.65		1.50 / 0.30	24	19280 / 9740	66 / 52	70
THT/CL-63-4T-3 IE3	1435	7.86	4.52		2.20	32	22150	68	64
THT/CL-63-4/8T-3	1415 / 700		4.80 / 1.85		2.20 / 0.45	32	22150 / 10920	68 / 53	77
THT/CL-63-4T-4 IE3	1430	11.01	6.33		3.00	38	24240	69	73
THT/CL-63-4/8T-4	1420 / 710		6.45 / 2.28		3.00 / 0.60	38	24240 / 12070	69 / 54	86
THT/CL-63-6T-0.75	930	2.90	1.75		0.55	28	13590	57	51
THT/CL-63-6/12T-0.75	940 / 455		2.35 / 1.15		0.60 / 0.15	28	13590 / 6550	57 / 42	55
THT/CL-63-6T-1 IE3	940	3.36	1.93		0.75	38	15890	58	54
THT/CL-63-6/12T-1	935 / 455		3.75 / 2.76		0.80 / 0.20	38	15890 / 7700	58 / 43	61
THT/CL-71-4T-1.5 IE3	1420	4.10	2.37		1.10	12	19480	71	58
THT/CL-71-4/8T-1.5	1440 / 705		2.69 / 1.12		1.10 / 0.25	12	19480 / 9500	71 / 56	61
THT/CL-71-4T-2 IE3	1425	5.89	3.38		1.50	14	20900	70	61
THT/CL-71-4/8T-2	1415 / 715		3.40 / 1.65		1.50 / 0.30	14	20900 / 10560	70 / 56	76
THT/CL-71-4T-3 IE3	1435	7.86	4.52		2.20	22	25100	70	70
THT/CL-71-4/8T-3	1415 / 700		4.80 / 1.85		2.20 / 0.45	22	25100 / 12370	70 / 55	82
THT/CL-71-4T-4 IE3	1430	11.01	6.33		3.00	28	27480	70	79
THT/CL-71-4/8T-4	1420 / 710		6.45 / 2.28		3.00 / 0.60	28	27480 / 13680	70 / 55	92
THT/CL-71-6T-0.75	930	2.90	1.75		0.55	20	16100	60	57
THT/CL-71-6/12T-0.75	940 / 455		2.35 / 1.15		0.60 / 0.15	20	16100 / 7760	60 / 45	61
THT/CL-71-6T-1 IE3	940	3.36	1.93		0.75	26	17300	60	61
THT/CL-71-6/12T-1	935 / 455		3.75 / 2.76		0.80 / 0.20	26	17300 / 8380	60 / 45	67

Technical characteristics

Model	Speed (r/min)	Maximum admissible current (A)			Installed power (kW)	Blade tilt angle (°)	Maximum flow rate (m³/h)	Sound pressure level¹	Approx. weight (Kg)
		230V	400V	690V				Inlet dB (A)	
THT/CL-71-6T-1.5 IE3	945	4.73	2.72		1.10	34	19930	61	69
THT/CL-71-6/12T-1.5	940 / 460		3.52 / 2.00		1.20 / 0.30	34	19930 / 9760	61 / 46	77
THT/CL-80-4T-3 IE3	1435	7.86	4.52		2.20	12	25450	75	79
THT/CL-80-4/8T-3	1415 / 670		4.80 / 1.85		2.20 / 0.45	12	25450 / 12550	75 / 60	91
THT/CL-80-4T-4 IE3	1430	11.01	6.33		3.00	16	30250	74	88
THT/CL-80-4/8T-4	1420 / 710		6.45 / 2.28		3.00 / 0.60	16	30250 / 15060	74 / 59	101
THT/CL-80-4T-5.5 IE3	1440		7.95	4.61	4.00	18	32750	73	94
THT/CL-80-4/8T-5.5	1450 / 715		7.88 / 2.87		3.80 / 1.00	18	32750 / 16150	73 / 58	127
THT/CL-80-6T-1.5 IE3	945	4.73	2.72		1.10	18	21450	63	78
THT/CL-80-6/12T-1.5	940 / 460		3.52 / 2.00		1.20 / 0.30	18	21450 / 10500	63 / 48	86
THT/CL-80-6T-2 IE3	945	6.25	3.62		1.50	26	25950	64	87
THT/CL-80-6/12T-2	960 / 470		4.46 / 3.43		1.60 / 0.40	26	25950 / 12700	64 / 49	91
THT/CL-80-6T-3 IE3	950	9.78	5.62		2.20	32	29930	65	94
THT/CL-80-6/12T-3	940 / 475		5.62 / 3.32		2.20 / 0.55	32	29930 / 15120	65 / 51	100
THT/CL-80-8T-0.75	700	3.48	2.00		0.55	20	17540	57	71
THT/CL-80-8T-1	710	5.06	2.92		0.75	28	20650	58	78
THT/CL-90-4T-4 IE3	1430	11.01	6.33		3.00	8	33580	79	110
THT/CL-90-4/8T-4	1420 / 710		6.45 / 2.28		3.00 / 0.60	8	33580 / 16720	79 / 64	124
THT/CL-90-4T-5.5 IE3	1440		7.95	4.61	4.00	12	38890	78	117
THT/CL-90-4/8T-5.5	1450 / 715		7.88 / 2.87		3.80 / 1.00	12	38890 / 19170	78 / 63	150
THT/CL-90-4T-7.5 IE3	1430		10.40	6.04	5.50	18	46140	77	143
THT/CL-90-4/8T-7.5	1455 / 725		11.40 / 3.86		5.50 / 1.10	18	46140 / 22910	77 / 62	157
THT/CL-90-4T-10 IE3	1460		14.20	8.17	7.50	22	50140	76	154
THT/CL-90-4/8T-10	1455 / 725		15.10 / 5.16		7.50 / 1.50	22	50140 / 24900	76 / 61	157
THT/CL-90-6T-2 IE3	945	6.25	3.62		1.50	16	28780	66	110
THT/CL-90-6/12T-2	960 / 470		4.46 / 3.43		1.60 / 0.40	16	28780 / 14090	66 / 51	114
THT/CL-90-6T-3 IE3	950	9.78	5.62		2.20	24	34000	66	116
THT/CL-90-6/12T-3	940 / 475		5.62 / 3.32		2.20 / 0.55	24	34000 / 17180	66 / 52	123
THT/CL-90-6T-4 IE3	945	12.80	6.36		3.00	30	38900	69	142
THT/CL-90-6/12T-4	970 / 485		7.37 / 3.53		2.80 / 0.70	30	38900 / 19450	69 / 54	143
THT/CL-90-8T-1	710	5.06	2.92		0.75	18	22900	60	100
THT/CL-90-8T-2	700	7.32	4.21		1.50	30	29490	63	116
THT/CL-90-8T-3	705	9.30	5.35		2.20	32	30850	64	134
THT/CL-100-4T-7.5 IE3	1430		10.40	6.04	5.50	10	46850	82	151
THT/CL-100-4/8T-7.5	1455 / 725		11.40 / 3.86		5.50 / 1.10	10	46850 / 23260	82 / 67	165
THT/CL-100-4T-10 IE3	1460		14.20	8.17	7.50	16	57400	79	162
THT/CL-100-4/8T-10	1455 / 725		15.10 / 5.16		7.50 / 1.50	14	54710 / 27170	80 / 65	165
THT/CL-100-4T-15 IE3	1455		20.70	11.99	11.00	22	66300	79	215
THT/CL-100-4/8T-15	1470 / 730		20.70 / 7.19		11.00 / 3.00	22	66300 / 32880	79 / 64	215
THT/CL-100-4T-20 IE3	1460		27.80	16.03	15.00	28	76150	80	230
THT/CL-100-4/8T-20	1470 / 725		31.72 / 11.75		15.00 / 3.80	28	76150 / 37560	80 / 65	230
THT/CL-100-4T/9-15 IE3	1460		20.70	11.99	11.00	18	55340	80	224
THT/CL-100-4T/9-20 IE3	1460		27.80	16.03	15.00	22	63260	80	239
THT/CL-100-4T/9-25 IE3	1475		35.40	20.39	18.50	26	70625	80	269
THT/CL-100-4T/9-30 IE3	1475		42.20	24.44	22.00	30	74845	82	286
THT/CL-100-6T-3 IE3	950	9.78	5.62		2.20	16	37600	70	124
THT/CL-100-6/12T-3	940 / 475		5.62 / 3.32		2.20 / 0.55	16	37600 / 18990	70 / 56	130
THT/CL-100-6T-4 IE3	945	12.80	6.36		3.00	20	41150	69	150
THT/CL-100-6/12T-4	970 / 485		7.37 / 3.53		2.80 / 0.70	20	41150 / 20580	69 / 54	151
THT/CL-100-6T-5.5 IE3	970		8.37	4.82	4.00	26	47780	70	162
THT/CL-100-6T/9-5.5 IE3	970		11.00	6.35	4.00	20	39020	70	165
THT/CL-100-6T/9-7.5 IE3	970		12.30	7.07	5.50	26	46765	71	173
THT/CL-100-6T/9-10 IE3	970		15.20	8.83	7.50	34	52255	74	213
THT/CL-125-4T/6-20 IE3	1460		27.80	16.03	15.00	10	78600	87	318
THT/CL-125-4/8T/6-20	1470 / 725		31.72 / 11.75		15.00 / 3.80	10	78600 / 38770	87 / 72	318

Technical characteristics

Model	Speed (r/min)	Maximum admissible current (A)			Installed power (kW)	Blade tilt angle (°)	Maximum flow rate (m³/h)	Sound pressure level¹ dB (A) Inlet	Approx. weight (Kg)
		230V	400V	690V					
THT/CL-125-4T/6-25 IE3	1465		35.40	20.39	18.50	14	92550	86	386
THT/CL-125-4/8T/6-27	1470 / 730		39.70 / 14.10		20.00 / 5.00	16	98830 / 48910	85 / 70	400
THT/CL-125-4T/6-30 IE3	1470		42.20	24.44	22.00	16	98830	85	400
THT/CL-125-4/8T/6-37	1475 / 735		54.55 / 18.50		28.00 / 6.50	20	110890 / 55260	85 / 70	481
THT/CL-125-4T/6-40 IE3	1475		53.30	31.02	30.00	22	117450	85	481
THT/CL-125-4T/6-50 IE3	1480		66.80	38.70	37.00	26	131050	85	529
THT/CL-125-4T/6-60 IE3	1475		80.90	46.90	45.00	28	135820	85	599
THT/CL-125-4T/6-75 IE3	1480		98.60	57.20	55.00	34	152100	88	699
THT/CL-125-4T/9-25 IE3	1465		35.40	20.39	18.50	10	79650	87	395
THT/CL-125-4T/9-30 IE3	1470		42.20	24.44	22.00	12	88290	86	409
THT/CL-125-4/8T/9-27	1470 / 730		39.70 / 14.10		20.00 / 5.00	12	88290 / 43690	86 / 71	409
THT/CL-125-4/8T/9-37	1475 / 735		54.55 / 18.50		28.00 / 6.50	16	104040 / 51840	85 / 70	490
THT/CL-125-4T/9-40 IE3	1475		53.30	31.02	30.00	16	104040	85	490
THT/CL-125-4T/9-50 IE3	1480		66.80	38.70	37.00	20	118400	85	538
THT/CL-125-4T/9-60 IE3	1475		80.90	46.90	45.00	24	134970	85	590
THT/CL-125-4T/9-75 IE3	1480		98.60	57.20	55.00	28	146770	86	690
THT/CL-125-4T/9-100 IE3	1480		128.00	74.22	75.00	34	158560	88	829
THT/CL-125-4T/12-50 IE3	1480		66.80	38.70	37.00	18	101660	86	560
THT/CL-125-4T/12-60 IE3	1475		80.90	46.90	45.00	20	109180	86	605
THT/CL-125-4T/12-75 IE3	1480		98.60	57.20	55.00	26	131240	86	705
THT/CL-125-4T/12-100 IE3	1480		128.00	74.22	75.00	32	154100	88	835
THT/CL-125-6T/6-5.5 IE3	970		8.37	4.82	4.00	10	51500	77	251
THT/CL-125-6T/6-7.5 IE3	970		12.30	7.07	5.50	14	60640	75	258
THT/CL-125-6/12T/6-7.5	970 / 480		14.50 / 5.17		5.50 / 1.00	14	60640 / 30010	75 / 60	272
THT/CL-125-6T/6-10 IE3	960		15.20	8.83	7.50	20	72650	74	283
THT/CL-125-6/12T/6-10	970 / 490		13.60 / 5.69		7.20 / 1.80	20	72650 / 36510	74 / 60	303
THT/CL-125-6T/6-15 IE3	955		22.50	13.07	11.00	26	85850	74	313
THT/CL-125-6/12T/6-15	970 / 485		23.10 / 8.41		11.00 / 3.00	26	85850 / 42710	74 / 59	318
THT/CL-125-6T/6-20 IE3	950		29.00	16.78	15.00	30	92850	76	386
THT/CL-125-6/12T/6-24	970 / 480		41.60 / 13.21		17.60 / 2.85	34	99650 / 49320	78 / 63	481
THT/CL-125-6T/9-10 IE3	960		15.20	8.83	7.50	14	63490	77	292
THT/CL-125-6/12T/9-10	970 / 490		13.60 / 5.69		7.20 / 1.80	14	63490 / 31910	77 / 63	312
THT/CL-125-6T/9-15 IE3	955		22.50	13.07	11.00	20	77550	75	322
THT/CL-125-6/12T/9-15	970 / 485		23.10 / 8.41		11.00 / 3.00	20	77550 / 38580	75 / 60	327
THT/CL-125-6T/9-20 IE3	950		29.00	16.78	15.00	26	92950	75	395
THT/CL-125-6/12T/9-24	970 / 480		41.60 / 13.21		17.60 / 2.85	30	98500 / 48750	76 / 61	490
THT/CL-125-6T/9-25 IE3	975		36.10	20.77	18.50	32	101450	77	416
THT/CL-125-6T/9-30 IE3	975		42.30	24.35	22.00	36	106525	80	426
THT/CL-125-6T/12-10 IE3	970		15.20	8.83	7.50	12	49630	79	372
THT/CL-125-6T/12-15 IE3	970		22.50	13.07	11.00	18	67315	77	382
THT/CL-125-6T/12-20 IE3	970		29.00	16.78	15.00	24	81840	76	440
THT/CL-125-6T/12-25 IE3	975		36.10	20.77	18.50	30	96765	77	450
THT/CL-125-6T/12-30 IE3	975		42.30	24.35	22.00	32	102040	78	460
THT/CL-125-6T/12-40 IE3	985		56.00	32.50	30.00	34	106355	79	615
THT/CL-140-6T/6-7.5 IE3	970		12.30	7.07	5.50	8	62800	83	297
THT/CL-140-6T/6-15 IE3	955		22.50	13.07	11.00	16	86640	78	366
THT/CL-140-6T/6-20 IE3	950		29.00	16.78	15.00	22	102950	77	445
THT/CL-140-6T/6-25 IE3	975		36.10	20.77	18.50	24	108750	77	497
THT/CL-140-6T/6-30 IE3	975		42.30	24.35	22.00	28	119050	77	506
THT/CL-140-6T/9-15 IE3	955		22.50	13.07	11.00	12	77400	82	375
THT/CL-140-6T/9-20 IE3	950		29.00	16.78	15.00	16	91200	81	455
THT/CL-140-6T/9-25 IE3	975		36.10	20.77	18.50	20	103800	80	506
THT/CL-140-6T/9-30 IE3	975		42.30	24.35	22.00	22	111000	79	515
THT/CL-140-6T/9-40 IE3	985		56.00	32.50	30.00	28	128800	79	673
THT/CL-140-6T/9-50 IE3	980		67.20	39.00	37.00	32	135750	80	751

Technical characteristics

Model	Speed (r/min)	Maximum admissible current (A)			Installed power (kW)	Blade tilt angle (°)	Maximum flow rate (m³/h)	Sound pressure level¹ dB (A) Inlet	Approx. weight (Kg)
		230V	400V	690V					
THT/CL-140-6T/9-60 IE3	985		84.40	48.90	45.00	38	145610	82	986
THT/CL-140-6T/12-30 IE3	975		42.30	24.35	22.00	20	101570	81	531
THT/CL-140-6T/12-40 IE3	985		56.00	32.50	30.00	28	128800	80	686
THT/CL-140-6T/12-50 IE3	985		67.20	39.00	37.00	32	143360	81	769
THT/CL-140-6T/12-60 IE3	985		84.40	48.90	45.00	36	156705	82	979
THT/CL-140-6T/12-75 IE3	985		103.00	59.70	55.00	38	162890	83	1004
THT/CL-160-6T/6-20 IE3	950		29.00	16.78	15.00	12	111990	85	532
THT/CL-160-6T/6-25 IE3	975		36.10	20.77	18.50	14	121100	84	584
THT/CL-160-6T/6-30 IE3	975		42.30	24.35	22.00	16	129330	83	593
THT/CL-160-6T/6-40 IE3	985		56.00	32.50	30.00	22	153700	82	768
THT/CL-160-6T/6-50 IE3	980		67.20	39.00	37.00	26	170800	81	842
THT/CL-160-6T/6-60 IE3	985		84.40	48.90	45.00	30	185460	82	1064
THT/CL-160-6T/6-75 IE3	985		103.00	59.70	55.00	34	199030	83	1109
THT/CL-160-6T/9-25 IE3	975		36.10	20.77	18.50	10	104250	90	594
THT/CL-160-6T/9-30 IE3	975		42.30	24.35	22.00	14	126800	88	603
THT/CL-160-6T/9-40 IE3	985		56.00	32.50	30.00	18	145500	86	778
THT/CL-160-6T/9-50 IE3	980		67.20	39.00	37.00	20	154940	85	852
THT/CL-160-6T/9-60 IE3	985		84.40	48.90	45.00	24	176750	85	1067
THT/CL-160-6T/9-75 IE3	985		103.00	59.70	55.00	28	192290	84	1112
THT/CL-160-6T/12-60 IE3	985		84.40	48.90	45.00	20	151615	86	1071
THT/CL-160-6T/12-75 IE3	985		103.00	59.70	55.00	26	182250	85	1116

1 The noise level values are pressures in dB(A) measured at a distance of 3 metres in a free field.



Erp. (Energy Related Products)

Information on Directive 2009/125/EC can be downloaded from the SODECA website or the QuickFan selector programme.

Acoustic characteristics

Sound power spectrum Lw(A) in dB(A) per Hz frequency band
Values measured at inlet with maximum flow rate

	63	125	250	500	1000	2000	4000	8000		63	125	250	500	1000	2000	4000	8000
40-2-1.5	47	63	75	83	88	86	82	75	56-4-12 (2V)	39	52	70	78	80	79	74	67
40-4-1.5 (2V)	32	48	60	68	73	71	67	60	56-4-1	51	63	72	78	78	78	72	64
40-2-2	47	63	75	83	88	86	82	75	56-4-1.5	51	63	72	78	78	78	72	64
40-4-2 (2V)	32	48	60	68	73	71	67	60	56-8-1.5 (2V)	35	47	56	62	62	62	56	48
40-4-0.75	37	53	63	70	71	68	67	68	56-4-2	52	64	73	79	79	79	73	65
40-6-0.75	28	44	54	61	62	59	58	59	56-6-0.75	45	55	65	69	70	68	61	53
40-12-0.75 (2V)	12	28	38	45	46	43	42	43	56-12-0.75 (2V)	29	39	49	53	54	52	45	37
45-2-2	47	60	74	86	87	86	82	74	63-2-12	64	81	91	97	98	97	95	97
45-4-2 (2V)	32	45	59	71	72	71	67	59	63-2-20	63	80	90	96	97	96	94	96
45-2-3	47	64	74	81	88	86	83	75	63-4-1	48	64	76	82	84	81	74	66
45-4-3 (2V)	32	49	59	66	73	71	68	60	63-4-1.5	47	63	75	81	83	80	73	65
45-2-4	52	69	78	84	88	88	83	75	63-8-1.5 (2V)	31	47	59	65	67	64	57	49
45-4-0.75	47	59	67	73	73	73	68	60	63-4-2	54	66	75	81	81	81	75	67
45-6-0.75	37	49	57	63	63	63	58	50	63-8-2 (2V)	39	51	60	66	66	66	60	52
45-12-0.75 (2V)	21	33	41	47	47	47	42	34	63-4-3	56	68	77	83	83	83	77	69
50-2-3	58	74	84	91	92	89	88	89	63-8-3 (2V)	41	53	62	68	68	68	62	54
50-2-4	58	74	84	91	92	89	88	89	63-4-4	57	69	78	84	84	84	78	70
50-4-4 (2V)	43	59	69	76	77	74	73	74	63-8-4 (2V)	42	54	63	69	69	69	63	55
50-2-6	58	74	84	91	92	89	88	89	63-6-0.75	48	58	68	72	73	71	64	56
50-4-6 (2V)	43	59	69	76	77	74	73	74	63-12-0.75 (2V)	32	42	52	56	57	55	48	40
50-4-0.75	49	61	69	75	75	75	70	62	63-6-1	49	59	69	73	74	72	65	57
50-6-0.75	41	53	61	67	67	67	62	54	63-12-1 (2V)	32	42	52	56	57	55	48	40
56-2-5.5	53	66	84	92	94	93	88	81	71-4-1.5	57	73	80	86	86	86	82	74
56-2-6	53	66	84	92	94	93	88	81	71-8-1.5 (2V)	41	57	64	70	70	70	66	58
56-4-6 (2V)	38	51	69	77	79	78	73	66	71-4-2	56	72	79	85	85	85	81	73
56-2-12	54	67	85	93	95	94	89	82	71-8-2 (2V)	41	57	64	70	70	70	66	58

Dimensions mm

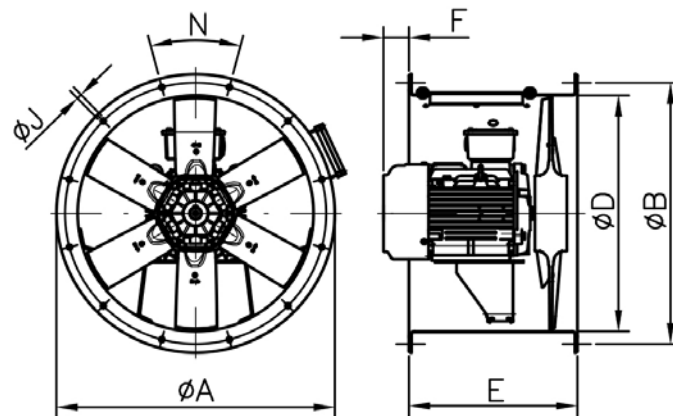

Motor size	ØA	ØB	ØD	E	F*	ØJ	N	
THT/CL-40	80	490	450	410	400	-	12	8x45°
THT/CL-40	90S	490	450	410	400	-	12	8x45°
THT/CL-40	90L	490	450	410	400	29	12	8x45°
THT/CL-45	80	540	500	460	400	-	12	8x45°
THT/CL-45	90S	540	500	460	400	-	12	8x45°
THT/CL-45	90L	540	500	460	400	29	12	8x45°
THT/CL-45	100	540	500	460	400	35	12	8x45°
THT/CL-50	80	600	560	514	400	-	12	12x30°
THT/CL-50	90S	600	560	514	400	-	12	12x30°
THT/CL-50	90L	600	560	514	400	29	12	12x30°
THT/CL-50	100	600	560	514	400	35	12	12x30°
THT/CL-50	112	600	560	514	400	56.5	12	12x30°
THT/CL-56	80	660	620	560	400	-	12	12x30°
THT/CL-56	90S	660	620	560	400	-	12	12x30°
THT/CL-56	90L	660	620	560	400	29	12	12x30°
THT/CL-56	100	660	620	560	500	-	12	12x30°
THT/CL-56	112	660	620	560	500	60.5	12	12x30°
THT/CL-56	132S	660	620	560	500	15	12	12x30°
THT/CL-56	132M	660	620	560	500	53	12	12x30°
THT/CL-63	80	730	690	640	400	-	12	12x30°
THT/CL-63	90S	730	690	640	400	-	12	12x30°
THT/CL-63	90L	730	690	640	400	29	12	12x30°
THT/CL-63	100	730	690	640	500	-	12	12x30°
THT/CL-63	112	730	690	640	500	-	12	12x30°
THT/CL-63	132S	730	690	640	500	43	12	12x30°
THT/CL-63	132M	730	690	640	500	81	12	12x30°
THT/CL-63	160M	730	690	640	650	-	12	12x30°
THT/CL-63	160L	730	690	640	650	29	12	12x30°
THT/CL-71	80	810	770	710	430	-	12	16x22°30'
THT/CL-71	90S	810	770	710	430	-	12	16x22°30'
THT/CL-71	90L	810	770	710	430	19	12	16x22°30'
THT/CL-71	100	810	770	710	430	24	12	16x22°30'
THT/CL-71	112	810	770	710	500	-	12	16x22°30'
THT/CL-80	90L	900	860	800	430	27	12	16x22°30'
THT/CL-80	100	900	860	800	500	-	12	16x22°30'
THT/CL-80	112	900	860	800	500	-	12	16x22°30'
THT/CL-80	132S	900	860	800	600	-	12	16x22°30'

Motor size	ØA	ØB	ØD	E	F*	ØJ	N	
THT/CL-90	100	1015	970	900	600	-	15	16x22°30'
THT/CL-90	112	1015	970	900	600	-	15	16x22°30'
THT/CL-90	132S	1015	970	900	600	-	15	16x22°30'
THT/CL-90	132M	1015	970	900	600	-	15	16x22°30'
THT/CL-100	112	1115	1070	1000	600	-	15	16x22°30'
THT/CL-100	132S	1115	1070	1000	600	-	15	16x22°30'
THT/CL-100	132M	1115	1070	1000	600	-	15	16x22°30'
THT/CL-100	160M	1115	1070	1000	700	-	15	16x22°30'
THT/CL-100	160L	1115	1070	1000	700	2	15	16x22°30'
THT/CL-100	180M	1115	1070	1000	700	11	15	16x22°30'
THT/CL-100	180L	1115	1070	1000	700	49	15	16x22°30'
THT/CL-125	132M	1365	1320	1250	700	-	15	20x18°
THT/CL-125	160M	1365	1320	1250	700	-	15	20x18°
THT/CL-125	160L	1365	1320	1250	700	-	15	20x18°
THT/CL-125	180M	1365	1320	1250	900	-	15	20x18°
THT/CL-125	180L	1365	1320	1250	900	-	15	20x18°
THT/CL-125	200	1365	1320	1250	900	-	15	20x18°
THT/CL-125	225	1365	1320	1250	1000	-	15	20x18°
THT/CL-125	250	1365	1320	1250	1000	25.5	15	20x18°
THT/CL-125	280	1365	1320	1250	1200	-	15	20x18°
THT/CL-140	132S	1515	1470	1400	650	-	15	20x18°
THT/CL-140	132M	1515	1470	1400	650	-	15	20x18°
THT/CL-140	160L	1515	1470	1400	700	5	15	20x18°
THT/CL-140	180L	1515	1470	1400	900	-	15	20x18°
THT/CL-140	200	1515	1470	1400	900	-	15	20x18°
THT/CL-140	225	1515	1470	1400	1000	-	15	20x18°
THT/CL-140	250	1515	1470	1400	1000	5.5	15	20x18°
THT/CL-140	280	1515	1470	1400	1200	5.5	15	20x18°
THT/CL-160	132S	1735	1680	1600	650	-	19	24x15°
THT/CL-160	132M	1735	1680	1600	650	-	19	24x15°
THT/CL-160	160L	1735	1680	1600	700	5	19	24x15°
THT/CL-160	180L	1735	1680	1600	900	-	19	24x15°
THT/CL-160	200	1735	1680	1600	900	-	19	24x15°
THT/CL-160	225	1735	1680	1600	1000	-	19	24x15°
THT/CL-160	250	1735	1680	1600	1000	30.5	19	24x15°
THT/CL-160	280	1735	1680	1600	1200	-	19	24x15°

* Dimension F only applies to F400 models.

Motor build sizes depending on power (1 speed)

	HP											
	0.75	1	1.5	2	3	4	5.5	7.5	10	12	15	20
2T (3000 r/min)	80	80	80	90S	90L	100LB	112M	132S	132S	132MA	160M	160M
4T (1500 r/min)	80	90S	90S	90L	100LA	100LB	112M	132S	132M	-	160ML	160L
6T (1000 r/min)	90S	90S	90L	100L	112M	132S	132MA	132MB	160M	-	160L	180ML
8T (750 r/min)	90L	100LA	100L	112M	132S	132M	160MA	160M	160L	-	180L	200MLA

	HP							
	22	25	30	40	50	60	75	100
2T (3000 r/min)	160L	180M	180L	200L	225S/M	225S/M	250S/M	280S/M
4T (1500 r/min)	-	180M	180L	200L	225S/M	225S/M	250S/M	280S/M
6T (1000 r/min)	-	200MLA	200MLB	225SMB	250S/M	280S/M	280S/M	-
8T (750 r/min)	-	225SMA	225SMB	250SMA	280S/M	280S/M	-	-

Motor build sizes depending on power (2 speeds)

	HP											
	0.75	1	1.5	2	3	4	5.5	6	7.5	8	9	10
2/4 (3000/1500 r/min)	-	-	90S	90S	90L	100L	-	112M	-	-	132M	-
4/8 (1500/750 r/min)	-	-	90S	100L	100LA	100LC	132S	-	132S	132S	132ML	132M
6/12 (1000/500 r/min)	90L	100L	100LB	112M	112M	132MC	160M	160M	160LB	160LB	-	160LB

	HP									
	12	15	18	20	22	24	27	37	38	40
2/4 (3000/1500 r/min)	160MA	-	160M	-	160L	-	-	-	-	-
4/8 (1500/750 r/min)	-	160M	-	160L	180M	180M	180L	200MLA	200L	225S/M
6/12 (1000/500 r/min)	-	200MLC	160L	200M	-	250SMB	225S/M	-	225S/M	-

Characteristic curves

See series characteristic curves: THT

Accessories



Configuration with BOXPARK



Control panels for car park ventilation systems with triple purpose: daily ventilation, CO concentration control and smoke extraction in case of fire

Control panels in metal enclosure with all the necessary elements for the management and control of fans in car park ventilation systems, whether they are based on duct networks or impulse fans, for the control of CO concentration levels and smoke extraction in case of fire. Customised panels for all power ratings and number of fans according to project requirements.

More information see BOXPARK series.

Installation examples with BOXPARK

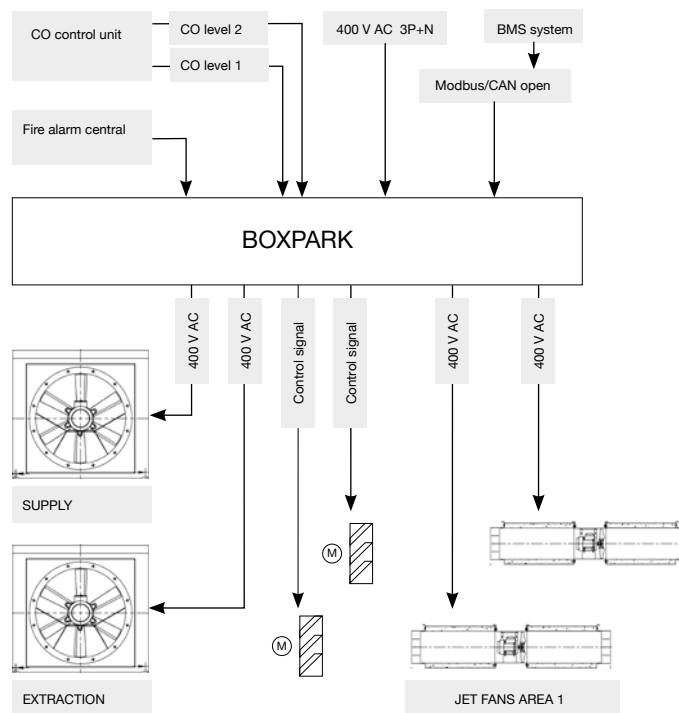

THT/WALL



Dynamic wall mounted extractor fans with motorised hatch, for smoke exhaust in case of fires, 400 °C/2h and 300 °C/2h



Dynamic wall-mount extractor fans with motorised opening system for connection to extract duct. Specially designed for the fast, effective exhaust of harmful smoke and gases in the event of fire. Suitable for installation in industrial buildings, stores or in any other type of building. Approved as a whole in accordance with standard EN 12101-3, with F400 and F300 certificate. Can be used for ambient ventilation.

Fan:

- Helicoidal casing support and fixing flange to allow easy wall anchorage and installation.
- With F400 certificate number 0370-CPR-2823 and F300 certificate number 0370-CPR-0973.
- Tubular casing in sheet steel with polyester resin anti-corrosive treatment.
- Variable angle impeller made of cast aluminium.
- Shielded power cable with EMC protection.
- Airflow direction from motor to impeller.

Extruded aluminum hatch:

- An extremely robust structure that is able to withstand severe weather changes.
- Designed to ensure watertightness.
- Aluminum profile with thermal bridge break.
- Central ceiling and structure equipped with high performance thermal insulation.

- Thermal resistance of the assembly less than 0.89 W/m²·K.
- Limit switches in both positions (open and closed).
- Manual opening system.

Motor:

- Class H motors for S1 continuous operation and S2 emergency use. With ball bearings, IP55 protection and 1 or 2 speeds, depending on model.
- IE3 efficiency motors.
- Three-phase 230/400 V 50 Hz (up to 3 kW) and 400/690 V 50 Hz (powers greater than 3 kW).
- Maximum temperature of air to be carried: S1 -25 °C +40 °C continuous service, also suitable for warm climates with temperatures up to 50 °C. S2 operation, 300 °C/2h, 400 °C/2h.

Actuator:

- Reliability greater than 11,000 dual cycles.
- Supply voltage at 230 V AC 50/60 Hz.
- Working temperature: -25 °C +60 °C.

Flap finish:

- Anti-corrosive in extruded aluminum.
- RAL 7016 supplied as standard. Any other RAL can be supplied on demand.

Order code

From size 40 to size 100

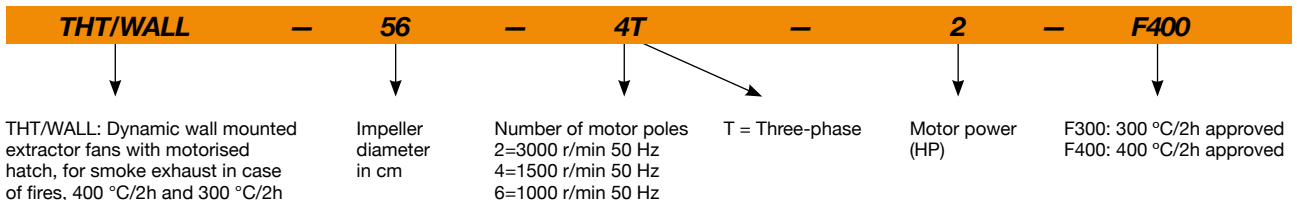

Size 125

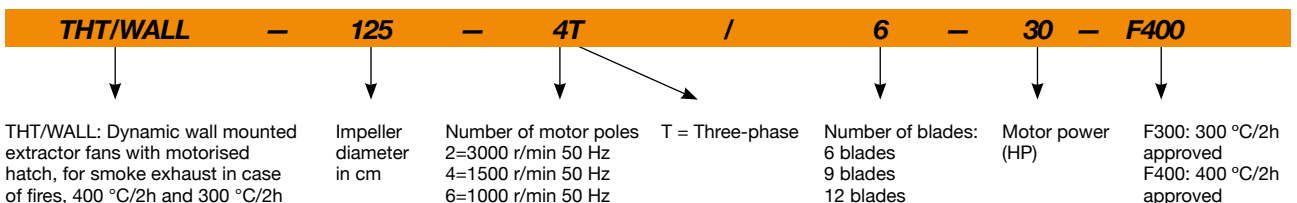

Technical characteristics

Model	Speed (r/min)	Maximum admissible current (A)			Installed power (kW)	Blade tilt angle (°)	Maximum flow rate (m³/h)	Sound pressure level ¹ dB (A)		Approx. weight (Kg)
		230V	400V	690V				Inlet	Exhaust	
THT/WALL-40-2T-1 IE3	2850	2.76	1.59		0.75	16	6100	62	62	62
THT/WALL-40-2T-1.5 IE3	2880	3.93	2.26		1.10	20	7040	61	61	63
THT/WALL-45-2T-2 IE3	2880	4.91	2.84		1.50	16	9400	61	61	67
THT/WALL-45-2T-3 IE3	2840	7.14	4.13		2.20	22	11325	61	61	68
THT/WALL-50-2T-4 IE3	2880	9.61	5.52		3.00	16	13860	66	66	84
THT/WALL-50-2T-5.5 IE3	2870		7.20	4.17	4.00	20	15900	66	66	100
THT/WALL-56-2T-5.5 IE3	2870		7.20	4.17	4.00	16	18820	68	68	105
THT/WALL-56-2T-7.5 IE3	2910		10.10	5.80	5.50	22	22510	68	68	107
THT/WALL-56-4T-2 IE3	1440	5.89	3.38		1.50	36	15020	54	54	84
THT/WALL-63-4T-3 IE3	1425	7.86	4.52		2.20	32	22170	58	58	131
THT/WALL-63-4T-4 IE3	1430	11.01	6.33		3.00	38	24240	59	59	132
THT/WALL-63-6T-1 IE3	940	3.36	1.93		0.75	38	15890	48	48	121
THT/WALL-71-4T-3 IE3	1425	7.86	4.52		2.20	22	25100	60	60	124
THT/WALL-71-4T-4 IE3	1430	11.01	6.33		3.00	28	27480	60	60	133
THT/WALL-71-4T-5.5 IE3	1440		7.95	4.61	4.00	38	32250	61	61	143
THT/WALL-71-6T-1.5 IE3	945	4.73	2.72		1.10	34	19930	51	51	123
THT/WALL-80-4T-3 IE3	1425	7.86	4.52		2.20	12	25460	65	65	138
THT/WALL-80-4T-4 IE3	1430	11.01	6.33		3.00	16	30270	64	64	147
THT/WALL-80-4T-5.5 IE3	1440		7.95	4.61	4.00	18	32770	63	63	153
THT/WALL-80-4T-7.5 IE3	1460		10.40	6.04	5.50	26	39640	63	63	154
THT/WALL-80-6T-1.5 IE3	945	4.73	2.72		1.10	18	21470	53	53	137
THT/WALL-80-6T-2 IE3	945	6.25	3.62		1.50	26	25970	54	54	146
THT/WALL-90-4T-7.5 IE3	1460		10.40	6.04	5.50	18	46140	67	67	222
THT/WALL-90-4T-10 IE3	1460		14.20	8.17	7.50	22	50140	66	66	233
THT/WALL-90-4T-15 IE3	1460		20.70	11.99	11.00	30	59390	68	68	242
THT/WALL-90-6T-3 IE3	950	9.78	5.62		2.20	24	34000	56	56	195
THT/WALL-90-6T-4 IE3	970	12.80	6.36		3.00	30	38910	59	59	221
THT/WALL-100-4T-10 IE3	1460		14.20	8.17	7.50	16	57420	69	69	239
THT/WALL-100-4T-15 IE3	1460		20.70	11.99	11.00	22	66300	69	69	292
THT/WALL-100-4T-20 IE3	1460		27.80	16.03	15.00	28	76160	70	70	307
THT/WALL-100-6T-5.5 IE3	970		8.37	4.82	4.00	26	47780	60	60	239
THT/WALL-100-6T-7.5 IE3	970		12.30	7.07	5.50	32	53520	62	62	276
THT/WALL-125-4T/6-20 IE3	1460		27.80	16.03	15.00	10	78600	77	77	462
THT/WALL-125-4T/6-25 IE3	1465		35.40	20.39	18.50	14	92550	76	76	530
THT/WALL-125-4T/6-30 IE3	1470		42.20	24.44	22.00	16	98830	75	75	544
THT/WALL-125-4T/6-40 IE3	1475		53.30	31.02	30.00	22	117450	75	75	625
THT/WALL-125-4T/6-50 IE3	1480		66.40	38.26	37.00	26	131050	75	75	673
THT/WALL-125-4T/9-25 IE3	1465		35.40	20.39	18.50	10	79650	77	77	539
THT/WALL-125-4T/9-30 IE3	1470		42.20	24.44	22.00	12	88290	76	76	553
THT/WALL-125-4T/9-40 IE3	1475		53.30	31.02	30.00	16	104040	75	75	634
THT/WALL-125-4T/9-50 IE3	1480		66.40	38.26	37.00	20	118400	75	75	682
THT/WALL-125-4T/12-30 IE3	1475		42.20	24.44	22.00	10	62900	78	78	569
THT/WALL-125-4T/12-40 IE3	1470		53.30	31.02	30.00	14	79180	77	77	650
THT/WALL-125-4T/12-50 IE3	1480		66.40	38.26	37.00	18	95715	76	76	693
THT/WALL-125-6T/6-5.5 IE3	970		8.37	4.82	4.00	10	51500	67	67	395
THT/WALL-125-6T/6-7.5 IE3	970		12.30	7.07	5.50	14	60640	65	65	402
THT/WALL-125-6T/6-10 IE3	960		15.20	8.83	7.50	20	72650	64	64	427
THT/WALL-125-6T/6-15 IE3	955		22.50	13.07	11.00	26	85850	64	64	457
THT/WALL-125-6T/6-20 IE3	950		29.00	16.78	15.00	30	92850	66	66	530
THT/WALL-125-6T/9-10 IE3	960		15.20	8.83	7.50	14	63490	67	67	436
THT/WALL-125-6T/9-15 IE3	955		22.50	13.07	11.00	20	77550	65	65	466
THT/WALL-125-6T/9-20 IE3	950		29.00	16.78	15.00	26	92950	65	65	539
THT/WALL-125-6T/9-25 IE3	975		36.10	20.77	18.50	32	96500	67	67	569
THT/WALL-125-6T/12-25 IE3	975		36.10	20.77	18.50	28	91680	67	67	579
THT/WALL-125-6T/12-30 IE3	975		42.30	24.35	22.00	32	102050	68	68	621
THT/WALL-125-6T/12-40 IE3	980		55.80	32.13	30.00	38	115950	72	72	739

¹ The noise level values are pressures in dB(A) measured at a distance of 10 metres in a free field.

Technical characteristics of the dynamic exhaust system based on standards EN-12101-3

Model	Approval	Motor insulation class	Durability	Temperature room temperature	Wind load
	(°C)			(°C)	
THT/WALL	F300 and F400	Class H	RE 11000	-25	WL 200



Erp. (Energy Related Products)

Information on Directive 2009/125/EC can be downloaded from the SODECA website or the QuickFan selector programme.

Acoustic characteristics

Sound power spectrum Lw(A) in dB(A) per Hz frequency band

Values measured at inlet with maximum flow rate

	63	125	250	500	1000	2000	4000	8000
40-2-1	48	64	76	84	89	87	83	76
40-2-1.5	47	63	75	83	88	86	82	75
45-2-2	47	60	74	86	87	86	82	74
45-2-3	47	64	74	81	88	86	83	75
50-2-4	58	74	84	91	92	89	88	89
50-2-5.5	58	74	84	91	92	89	88	89
56-2-5.5	53	66	84	92	94	93	88	81
56-2-7.5	53	66	84	92	94	93	88	81
56-4-2	52	64	73	79	79	79	73	65
63-4-3	56	68	77	83	83	83	77	69
63-4-4	57	69	78	84	84	84	78	70
63-6-1	49	59	69	73	74	72	65	57
71-4-3	56	72	79	85	85	85	81	73
71-4-4	63	75	79	85	85	86	83	75
71-4-5.5	64	76	80	86	86	87	84	76
71-6-1.5	47	65	74	77	77	72	65	56
80-4-3	55	71	84	91	91	88	82	74
80-4-4	54	70	83	90	90	87	81	73
80-4-5.5	53	69	82	89	89	86	80	72
80-4-7.5	53	69	82	89	89	86	80	72
80-6-1.5	53	68	75	78	79	76	70	62
80-6-2	59	69	75	79	80	78	73	65
90-4-7.5	59	75	86	92	93	91	86	78
90-4-10	58	74	85	91	92	90	85	77
90-4-15	60	76	87	93	94	92	87	79
90-6-3	52	67	78	82	82	78	71	63
90-6-4	60	70	80	85	85	82	76	68
100-4-10	64	80	87	94	95	93	89	81
100-4-15	71	83	87	93	94	94	91	83
100-4-20	72	84	88	94	95	95	92	84
100-6-5.5	57	72	82	85	86	83	75	67
100-6-7.5	59	74	84	87	88	85	77	69
125-4/6-20	69	85	96	103	104	102	95	87
125-4/6-25	68	84	95	102	103	101	94	86
125-4/6-30	67	83	94	101	102	100	93	85
125-4/6-40	67	83	94	101	102	100	93	85
125-4/6-50	67	83	94	101	102	100	93	85
125-4/9-25	67	81	94	102	104	101	96	88
125-4/9-30	66	80	93	101	103	100	95	87
125-4/9-40	65	79	92	100	102	99	94	86
125-4/9-50	65	79	92	100	102	99	94	86
125-6/6-5.5	64	79	89	92	93	90	85	77
125-6/6-7.5	62	77	87	90	91	88	83	75
125-6/6-10	61	76	86	89	90	87	82	74
125-6/6-15	61	76	86	89	90	87	82	74
125-6/6-20	63	78	88	91	92	89	84	76
125-6/9-10	61	76	87	93	94	88	84	77
125-6/9-15	59	74	85	91	92	86	82	75
125-6/9-20	59	74	85	91	92	86	82	75
125-6/9-25	61	76	87	93	94	88	84	77
125-4/12-30	68	82	95	103	105	102	97	89
125-4/12-40	67	81	94	102	104	101	96	88
125-4/12-50	66	80	93	101	103	100	95	87
125-6/12-25	61	76	87	93	94	88	84	77
125-6/12-30	62	77	88	94	95	89	85	78
125-6/12-40	66	81	92	98	99	93	89	82

Values measured at exhaust with maximum flow rate

	63	125	250	500	1000	2000	4000	8000
40-2-1	48	64	76	84	89	87	83	76
40-2-1.5	47	63	75	83	88	86	82	75
45-2-2	47	60	74	86	87	86	82	74
45-2-3	47	64	74	81	88	86	83	75
50-2-4	58	74	84	91	92	89	88	89
50-2-5.5	58	74	84	91	92	89	88	89
56-2-5.5	53	66	84	92	94	93	88	81
56-2-7.5	53	66	84	92	94	93	88	81
56-4-2	52	64	73	79	79	79	73	65
63-4-3	56	68	77	83	83	83	77	69
63-4-4	57	69	78	84	84	84	78	70
63-6-1	49	59	69	73	74	72	65	57
71-4-3	56	72	79	85	85	85	81	73
71-4-4	63	75	79	85	85	86	83	75
71-4-5.5	64	76	80	86	86	87	84	76
71-6-1.5	47	65	74	77	77	72	65	56
80-4-3	55	71	84	91	91	88	82	74
80-4-4	54	70	83	90	90	87	81	73
80-4-5.5	53	69	82	89	89	86	80	72
80-4-7.5	53	69	82	89	89	86	80	72
80-6-1.5	53	68	75	78	79	76	70	62
80-6-2	59	69	75	79	80	78	73	65
90-4-7.5	59	75	86	92	93	91	86	78
90-4-10	58	74	85	91	92	90	85	77
90-4-15	60	76	87	93	94	92	87	79
90-6-3	52	67	78	82	82	78	71	63
90-6-4	60	70	80	85	85	82	76	68
100-4-10	64	80	87	94	95	93	89	81
100-4-15	71	83	87	93	94	94	91	83
100-4-20	72	84	88	94	95	95	92	84
100-6-5.5	57	72	82	85	86	83	75	67
100-6-7.5	59	74	84	87	88	85	77	69
125-4/6-20	69	85	96	103	104	102	95	87
125-4/6-25	68	84	95	102	103	101	94	86
125-4/6-30	67	83	94	101	102	100	93	85
125-4/6-40	67	83	94	101	102	100	93	85
125-4/6-50	67	83	94	101	102	100	93	85
125-4/9-25	67	81	94	102	104	101	96	88
125-4/9-30	66	80	93	101	103	100	95	87
125-4/9-40	65	79	92	100	102	99	94	86
125-4/9-50	65	79	92	100	102	99	94	86
125-6/6-5.5	64	79	89	92	93	90	85	77
125-6/6-7.5	62	77	87	90	91	88	83	75
125-6/6-10	61	76	86	89	90	87	82	74
125-6/6-15	61	76	86	89	90	87	82	74
125-6/6-20	63	78	88	91	92	89	84	76
125-6/9-10	61	76	87	93	94	88	84	77
125-6/9-15	59	74	85	91	92	86	82	75
125-6/9-20	59	74	85	91	92	86	82	75
125-6/9-25	61	76	87	93	94	88	84	77
125-4/12-30	68	82	95	103	105	102	97	89
125-4/12-40	67	81	94	102	104	101	96	88
125-4/12-50	66	80	93	101	103	100	95	87
125-6/12-25	61	76	87	93	94	88	84	77
125-6/12-30	62	77	88	94	95	89	85	78
125-6/12-40	66	81	92	98	99	93	89	82

Dimensions mm

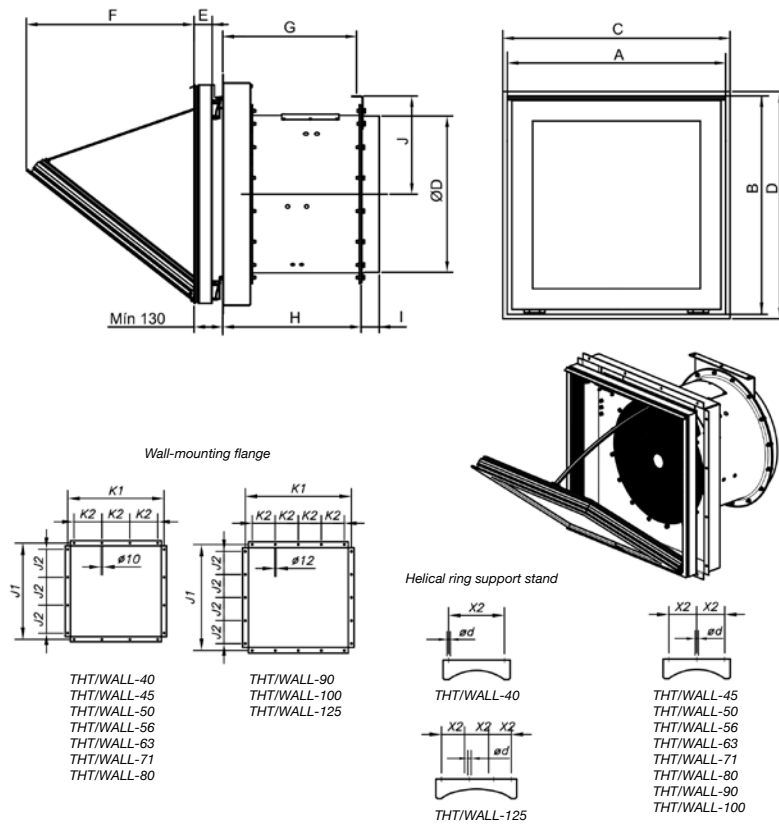

	A	B	C	D	ØD*	I	J	H	G	E	F	J1	J2	K1	K2	X2	ød
THT/WALL-40	640	590	650	600	400	80	255	530	510	82	430	700	200	700	200	200	10
THT/WALL-45	640	590	650	600	450	80	280	530	510	82	430	700	200	700	200	200	12
THT/WALL-50	690	690	700	700	500	80	305	530	510	82	560	790	220	790	220	200	12
THT/WALL-56	690	690	700	700	560	80	340	530	510	82	560	790	220	790	220	215	13
THT/WALL-56-2T-7.5	690	690	700	700	560	80	340	630	610	82	560	790	220	790	220	215	13
THT/WALL-63	990	990	1000	1000	630	80	385	630	605	82	760	1050	300	1050	300	215	13
THT/WALL-63-6T-1	990	990	1000	1000	630	80	385	530	505	82	760	1050	300	1050	300	215	13
THT/WALL-71	990	990	1000	1000	710	80	445	630	605	82	760	1050	300	1050	300	225	13
THT/WALL-80	990	990	1000	1000	800	100	490	630	605	82	760	1050	300	1050	300	280	13
THT/WALL-90	1190	1190	1200	1200	900	100	550	730	705	82	790	1250	250	1250	250	280	18
THT/WALL-90-4T-15	1190	1190	1200	1200	900	100	550	830	805	82	790	1250	250	1250	250	280	18
THT/WALL-100	1190	1190	1200	1200	1000	100	600	730	705	82	790	1250	250	1250	250	280	18
THT/WALL-100-4T-15	1190	1190	1200	1200	1000	100	600	830	805	82	790	1250	250	1250	250	280	18
THT/WALL-100-4T-20	1190	1190	1200	1200	1000	100	600	830	805	82	790	1250	250	1250	250	280	18
THT/WALL-125	1490	1490	1500	1500	1250	100	725	1050	1025	82	1240	1600	300	1600	300	300	18
THT/WALL-125-4T/6-20	1490	1490	1500	1500	1250	100	725	850	825	82	1240	1600	300	1600	300	300	18
THT/WALL-125-6T/6-5.5	1490	1490	1500	1500	1250	100	725	850	825	82	1240	1600	300	1600	300	300	18
THT/WALL-125-6T/6-7.5	1490	1490	1500	1500	1250	100	725	850	825	82	1240	1600	300	1600	300	300	18
THT/WALL-125-6T/6-10	1490	1490	1500	1500	1250	100	725	850	825	82	1240	1600	300	1600	300	300	18
THT/WALL-125-6T/6-15	1490	1490	1500	1500	1250	100	725	850	825	82	1240	1600	300	1600	300	300	18
THT/WALL-125-6T/9-10	1490	1490	1500	1500	1250	100	725	850	825	82	1240	1600	300	1600	300	300	18
THT/WALL-125-6T/9-15	1490	1490	1500	1500	1250	100	725	850	825	82	1240	1600	300	1600	300	300	18
THT/WALL-125-4T/6-50	1490	1490	1500	1500	1250	100	725	1150	1125	82	1240	1600	300	1600	300	300	18
THT/WALL-125-4T/9-50	1490	1490	1500	1500	1250	100	725	1150	1125	82	1240	1600	300	1600	300	300	18
THT/WALL-125-4T/12-50	1490	1490	1500	1500	1250	100	725	1150	1125	82	1240	1600	300	1600	300	300	18

* Recommended nominal tube diameter
(C x D) Nominal size of the wall opening.

Characteristic curves

Q= Flow rate in m³/h, m³/s and cfm

Pe= Static pressure in mm H₂O, Pa and in wg

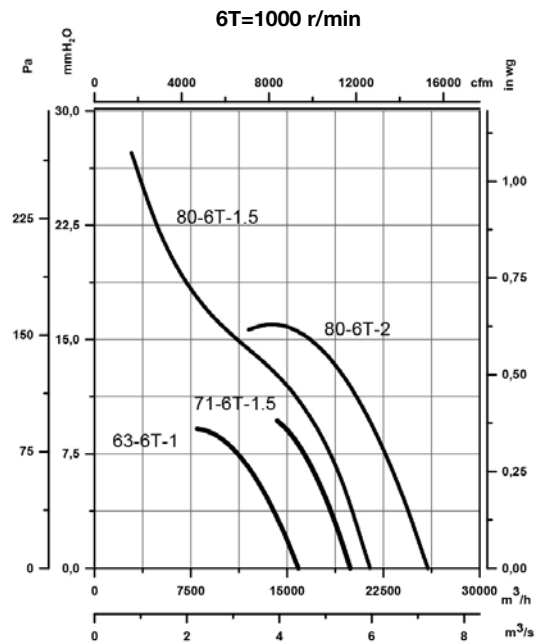
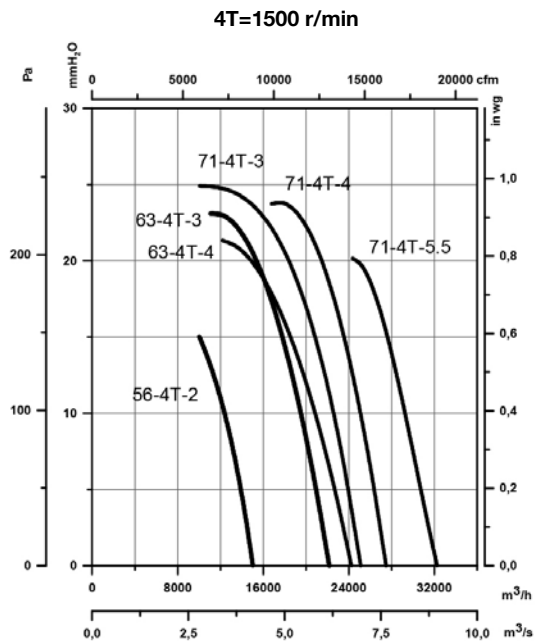
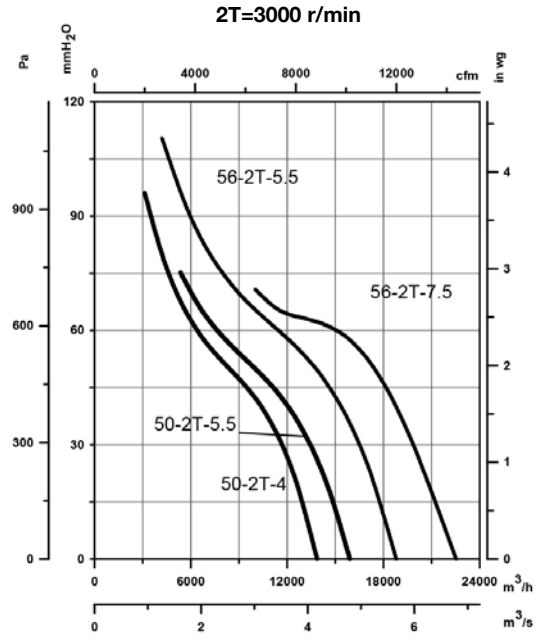
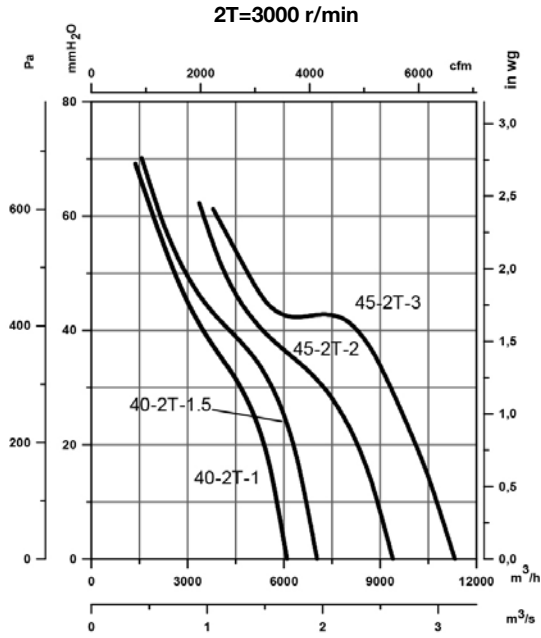

Characteristic curves

Q= Flow rate in m³/h, m³/s and cfm

Pe= Static pressure in mm H₂O, Pa and inwg

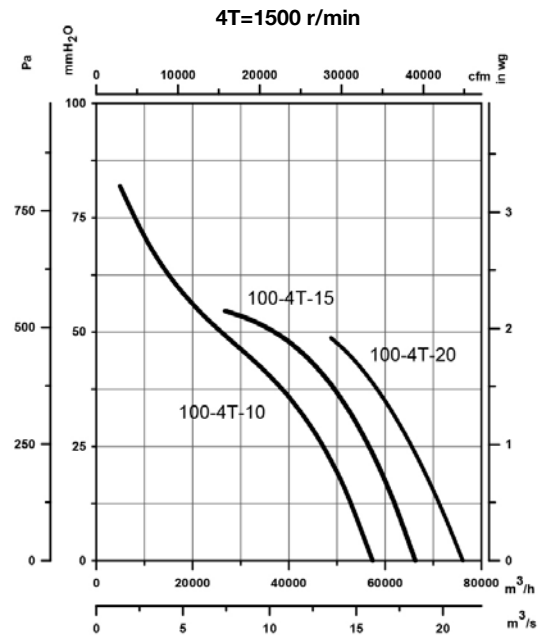
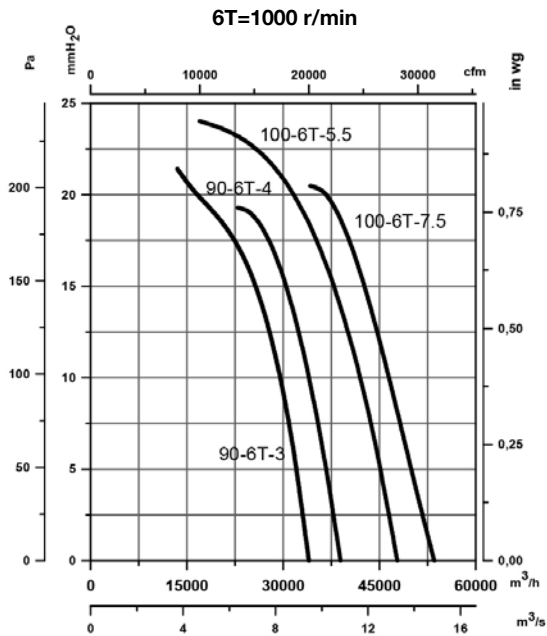
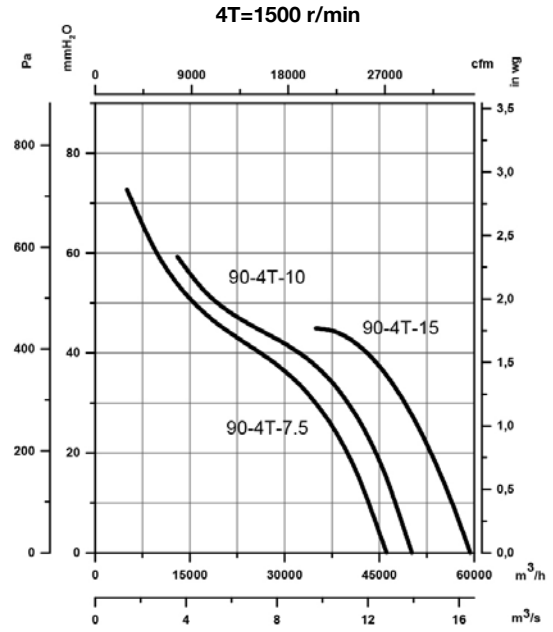
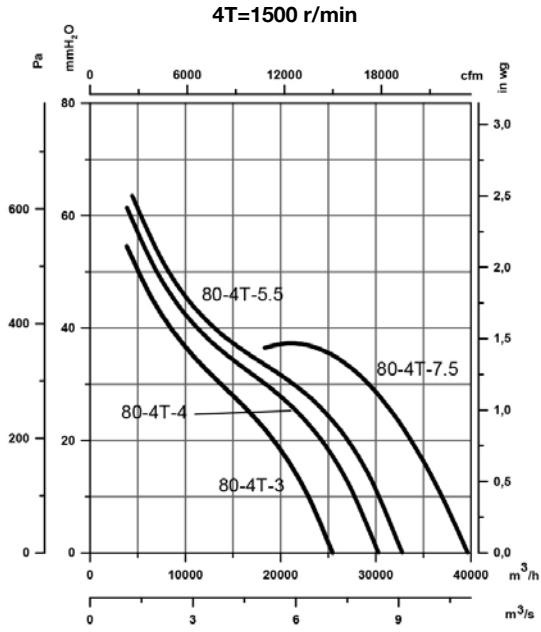

Characteristic curves

Q= Flow rate in m³/h, m³/s and cfm

Pe= Static pressure in mm H₂O, Pa and inwg

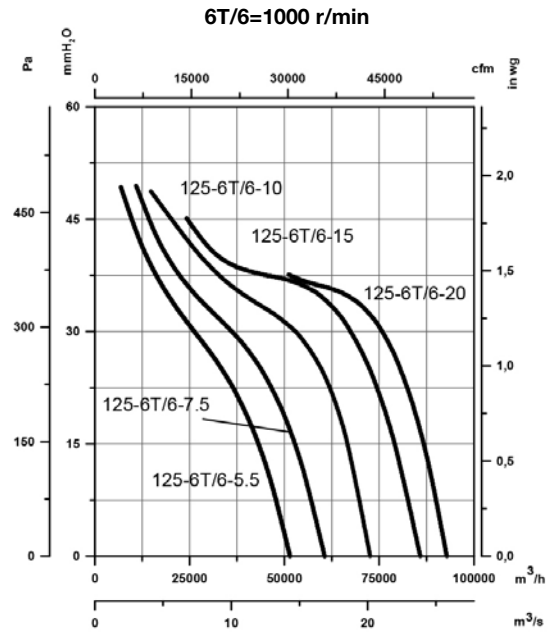
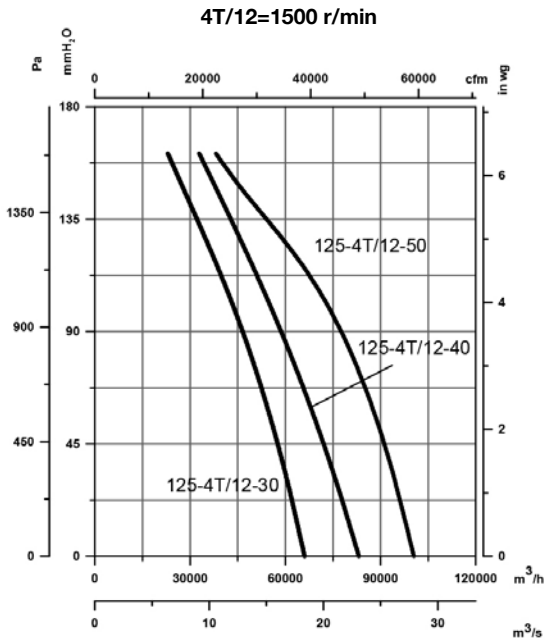
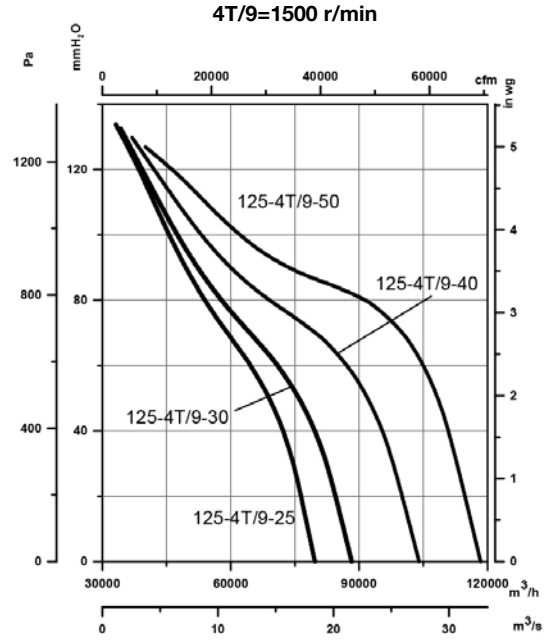
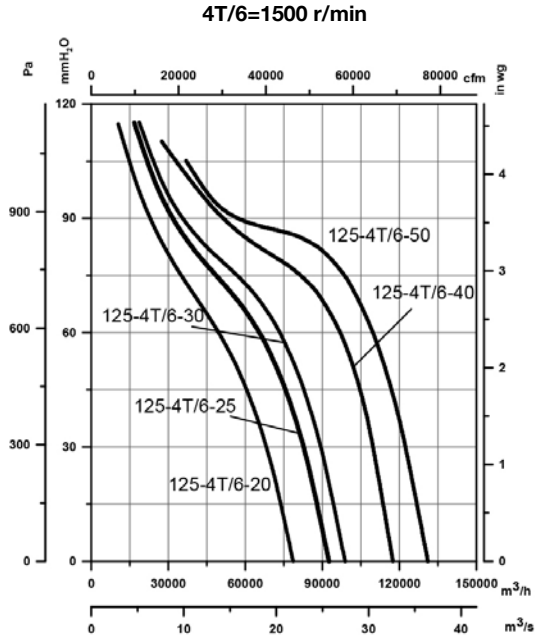

Characteristic curves

Q= Flow rate in m³/h, m³/s and cfm

Pe= Static pressure in mm H₂O, Pa and inwg

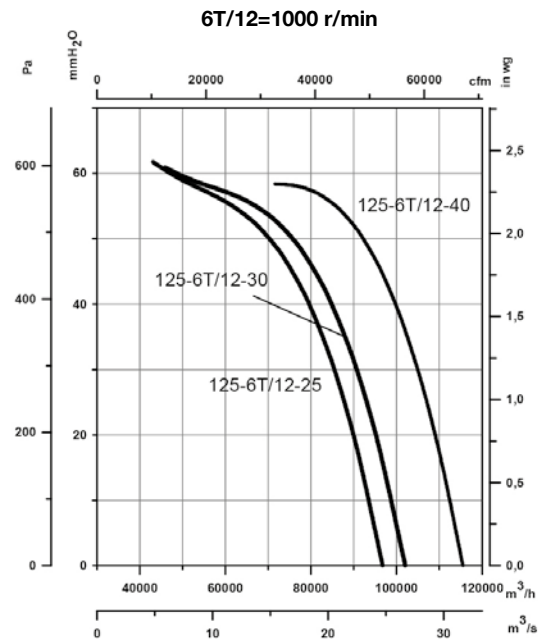
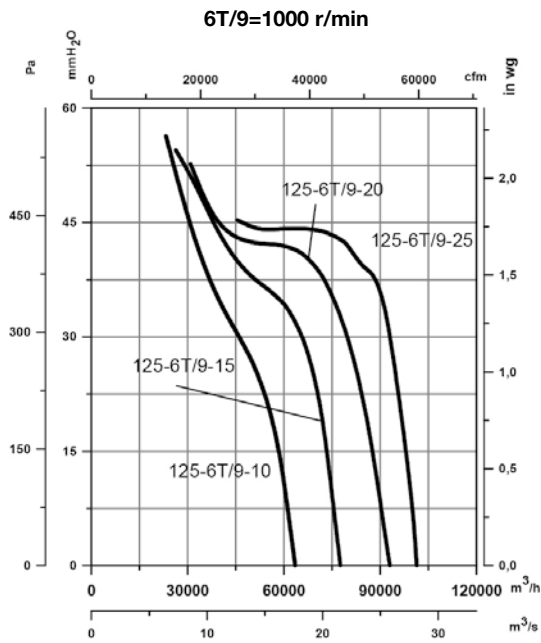

Accessories



INT



IAT



CABLE BOX



C2V



VSD3/A-RFT
- VSD1/A-RFM



CENTRAL CO



AET



P-400

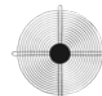

RT



R/THT



BAC



PS



ACE ACE/400



S

THT/WALL-F



Dynamic wall mounted extractor fans with motorised hatch, for smoke exhaust in case of fires, 400 °C/2h and 300 °C/2h



Dynamic wall extractor fans with motorised opening system and protective grating for use without extract duct. Specially designed for the fast, effective exhaust of harmful smoke and gases in the event of fire. Suitable for installation in industrial buildings, stores or in any other type of building. Approved as a whole in accordance with standard EN 12101-3, with F400 and F300 certificate. Can be used for ambient ventilation.

Fan:

- Wall fixing flange for correct and easy installation.
- Support frame in galvanized sheet steel.
- With F400 certificate number 0370-CPR-2823 and F300 certificate number 0370-CPR-0973.
- Variable angle impeller made of cast aluminium.
- Shielded power cable with EMC protection.
- Airflow direction from motor to impeller.
- Protection grid against contacts according to UNE-EN ISO 12499.

Extruded aluminum hatch:

- An extremely robust structure that is able to withstand severe weather changes.
- Designed to ensure watertightness.
- Aluminum profile with thermal bridge break.

- Central ceiling and structure equipped with high performance thermal insulation.
- Thermal resistance of the assembly less than 0.89 W/m²·K.
- Limit switches in both positions (open and closed).
- Manual opening system.

Motor:

- Class H motors for S1 continuous operation and S2 emergency use. With ball bearings, IP55 protection and 1 or 2 speeds, depending on model.
- IE3 efficiency motors.
- Three-phase 230/400 V 50 Hz (up to 3 kW) and 400/690 V 50 Hz (powers greater than 3 kW).
- Maximum temperature of air to be carried: S1 -25 °C +40 °C continuous service, also suitable for warm climates with temperatures up to 50 °C. S2 operation, 300 °C/2h, 400 °C/2h.

Actuator:

- Reliability greater than 11,000 dual cycles.
- Supply voltage at 230 V AC 50/60 Hz.
- Working temperature: -25 °C +60 °C.

Flap finish:

- Anti-corrosive in extruded aluminum.
- RAL 7016 supplied as standard. Any other RAL can be supplied on demand.

Order code

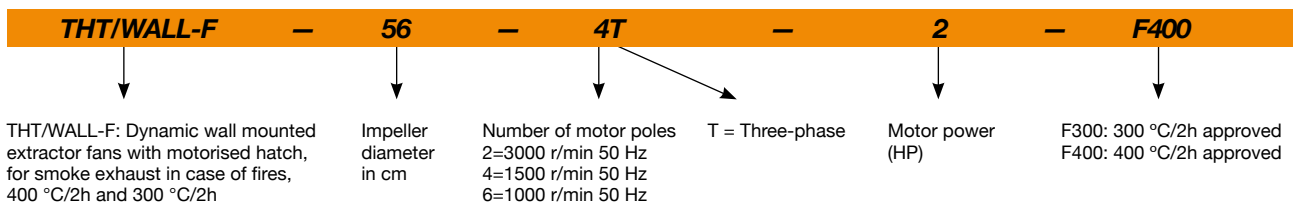

Technical characteristics

Model	Speed (r/min)	Maximum admissible current (A)			Installed power (kW)	Blade tilt angle (°)	Maximum flow rate (m³/h)	Sound pressure level ¹ dB (A)		Approx. weight (Kg)
		230V	400V	690V				Inlet	Exhaust	
THT/WALL-F-40-2T-1.5 IE3	2880	3.93	2.26		1.10	20	7040	61	61	55
THT/WALL-F-45-2T-2 IE3	2880	4.91	2.84		1.50	16	9400	61	61	63
THT/WALL-F-45-2T-3 IE3	2840	7.14	4.13		2.20	22	11325	61	61	67
THT/WALL-F-56-4T-2 IE3	1440	5.89	3.38		1.50	36	15020	54	54	69
THT/WALL-F-63-4T-3 IE3	1425	7.86	4.52		2.20	32	22170	58	58	97
THT/WALL-F-63-4T-4 IE3	1430	11.01	6.33		3.00	38	24240	59	59	103
THT/WALL-F-71-4T-3 IE3	1425	7.86	4.52		2.20	22	25100	60	60	100
THT/WALL-F-71-4T-4 IE3	1430	11.01	6.33		3.00	28	27480	60	60	106
THT/WALL-F-71-6T-1.5 IE3	945	4.73	2.72		1.10	34	19930	51	51	98
THT/WALL-F-80-4T-3 IE3	1425	7.86	4.52		2.20	12	25460	65	65	114
THT/WALL-F-80-4T-4 IE3	1430	11.01	6.33		3.00	16	30270	64	64	120
THT/WALL-F-80-4T-5.5 IE3	1440		7.95	4.61	4.00	18	32770	63	63	122
THT/WALL-F-80-4T-7.5 IE3	1460		10.4	6.04	5.50	26	39640	63	63	152
THT/WALL-F-80-6T-1.5 IE3	945	4.73	2.72		1.10	18	21470	53	53	112
THT/WALL-F-80-6T-2 IE3	945	6.25	3.62		1.50	26	25970	54	54	116
THT/WALL-F-90-4T-7.5 IE3	1460		10.4	6.04	5.50	18	46140	67	67	183
THT/WALL-F-90-4T-10 IE3	1460		14.2	8.17	7.50	22	50140	66	66	187
THT/WALL-F-90-6T-3 IE3	950	9.78	5.62		2.20	24	34000	56	56	145
THT/WALL-F-90-6T-4 IE3	970	12.8	6.36		3.00	30	38910	59	59	165
THT/WALL-F-100-4T-10 IE3	1460		14.2	8.17	7.50	16	57420	69	69	194
THT/WALL-F-100-4T-15 IE3	1460		20.7	11.99	11.00	22	66300	69	69	226
THT/WALL-F-100-4T-20 IE3	1460		27.8	16.03	15.00	28	76160	70	70	237
THT/WALL-F-100-6T-5.5 IE3	970		8.37	4.82	4.00	26	47780	60	60	178

¹ The noise level values are pressures in dB(A) measured at a distance of 10 metres in a free field.

Technical characteristics of the dynamic exhaust system based on standards EN-12101-3

Model	Approval (°C)	Motor insulation class	Durability	Temperature room temperature (°C)	Wind load (Pa)
THT/WALL-F	F300 and F400	Class H	RE 11000	-25	WL 200



Erp. (Energy Related Products)

Information on Directive 2009/125/EC can be downloaded from the SODECA website or the QuickFan selector programme.

Acoustic characteristics

Sound power spectrum Lw(A) in dB(A) per Hz frequency band

Values measured at inlet with maximum flow rate

	63	125	250	500	1000	2000	4000	8000
40-2-1.5	47	63	75	83	88	86	82	75
45-2-2	47	60	74	86	87	86	82	74
45-2-3	47	64	74	81	88	86	83	75
56-4-2	52	64	73	79	79	79	73	65
63-4-3	56	68	77	83	83	83	77	69
63-4-4	57	69	78	84	84	84	78	70
71-4-3	56	72	79	85	85	85	81	73
71-4-4	63	75	79	85	85	86	83	75
71-6-1.5	47	65	74	77	77	72	65	56
80-4-3	55	71	84	91	91	88	82	74

Values measured at exhaust with maximum flow rate

	63	125	250	500	1000	2000	4000	8000
40-2-1.5	47	63	75	83	88	86	82	75
45-2-2	47	60	74	86	87	86	82	74
45-2-3	47	64	74	81	88	86	83	75
56-4-2	52	64	73	79	79	79	73	65
63-4-3	56	68	77	83	83	83	77	69
63-4-4	57	69	78	84	84	84	78	70
71-4-3	56	72	79	85	85	85	81	73
71-4-4	63	75	79	85	85	86	83	75
71-6-1.5	47	65	74	77	77	72	65	56
80-4-3	55	71	84	91	91	88	82	74

Acoustic characteristics

Sound power spectrum Lw(A) in dB(A) per Hz frequency band

Values measured at inlet with maximum flow rate

	63	125	250	500	1000	2000	4000	8000
80-4-4	54	70	83	90	90	87	81	73
80-4-5.5	53	69	82	89	89	86	80	72
80-4-7.5	53	69	82	89	89	86	80	72
80-6-1.5	53	68	75	78	79	76	70	62
80-6-2	59	69	75	79	80	78	73	65
90-4-7.5	59	75	86	92	93	91	86	78
90-4-10	58	74	85	91	92	90	85	77
90-6-3	52	67	78	82	82	78	71	63
90-6-4	60	70	80	85	85	82	76	68
100-4-10	64	80	87	94	95	93	89	81
100-4-15	71	83	87	93	94	94	91	83
100-4-20	72	84	88	94	95	95	92	84
100-6-5.5	57	72	82	85	86	83	75	67

Values measured at exhaust with maximum flow rate

	63	125	250	500	1000	2000	4000	8000
80-4-4	54	70	83	90	90	87	81	73
80-4-5.5	53	69	82	89	89	86	80	72
80-4-7.5	53	69	82	89	89	86	80	72
80-6-1.5	53	68	75	78	79	76	70	62
80-6-2	59	69	75	79	80	78	73	65
90-4-7.5	59	75	86	92	93	91	86	78
90-4-10	58	74	85	91	92	90	85	77
90-6-3	52	67	78	82	82	78	71	63
90-6-4	60	70	80	85	85	82	76	68
100-4-10	64	80	87	94	95	93	89	81
100-4-15	71	83	87	93	94	94	91	83
100-4-20	72	84	88	94	95	95	92	84
100-6-5.5	57	72	82	85	86	83	75	67

Dimensions mm

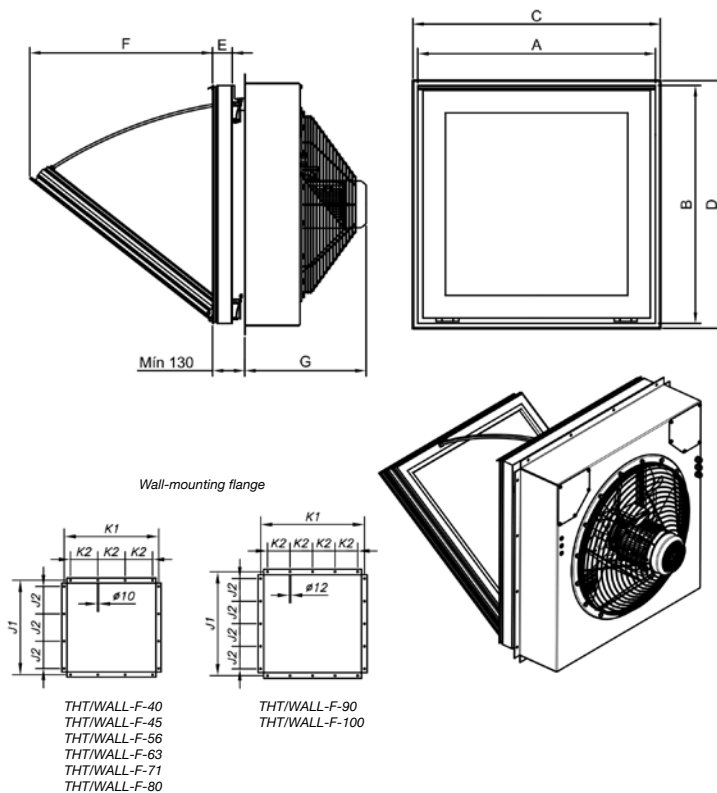

	A	B	C	D	E	F	G	J1	J2	K1	K2
THT/WALL-F-40	640	590	650	600	82	430	375	700	200	700	200
THT/WALL-F-45	640	590	650	600	82	430	400	700	200	700	200
THT/WALL-F-56	690	690	700	700	82	560	415	790	220	790	220
THT/WALL-F-63	990	990	1000	1000	82	760	475	1050	300	1050	300
THT/WALL-F-71	990	990	1000	1000	82	760	500	1050	300	1050	300
THT/WALL-F-80	990	990	1000	1000	82	760	500	1050	300	1050	300
THT/WALL-F-90	1190	1190	1200	1200	82	790	525	1250	250	1250	250
THT/WALL-F-100	1190	1190	1200	1200	82	790	550	1250	250	1250	250

(C x D) Nominal size of the wall opening.

Characteristic curves

Q= Flow rate in m³/h, m³/s and cfm

Pe= Static pressure in mm H₂O, Pa and in wg

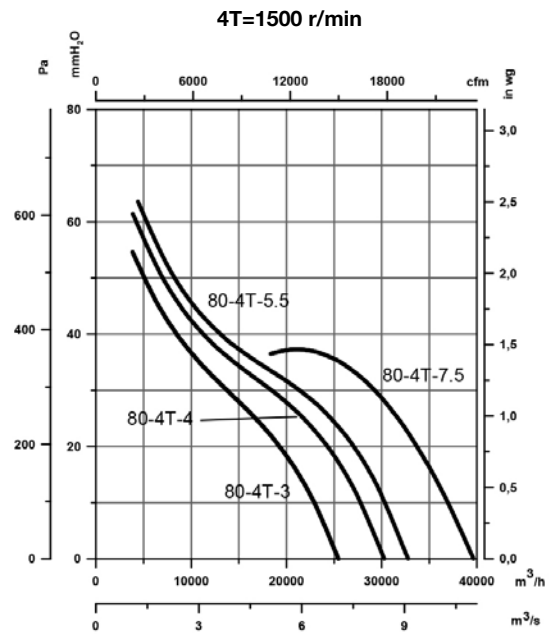
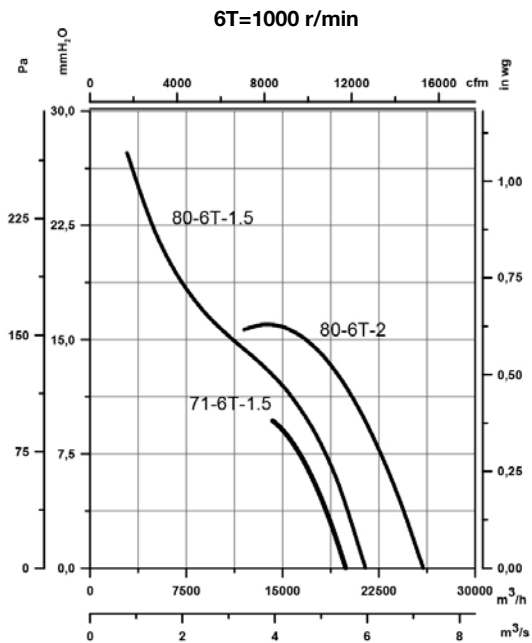
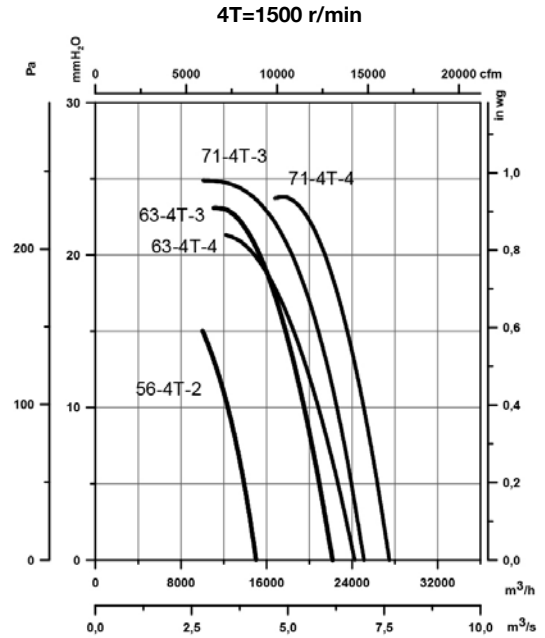
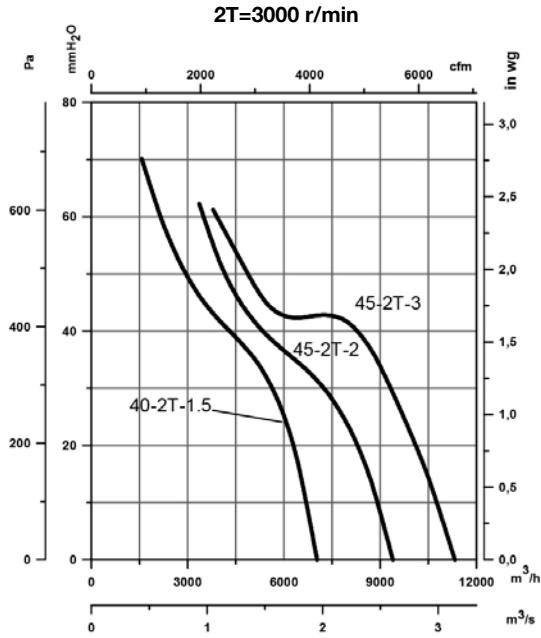

Characteristic curves

Q= Flow rate in m³/h, m³/s and cfm

Pe= Static pressure in mm H₂O, Pa and inwg

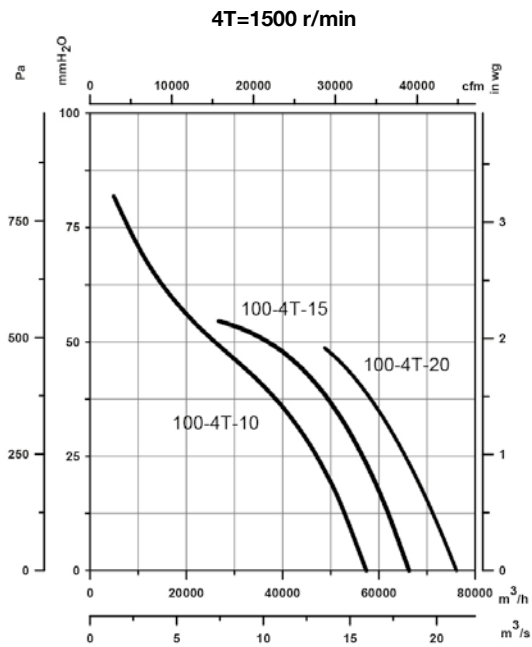
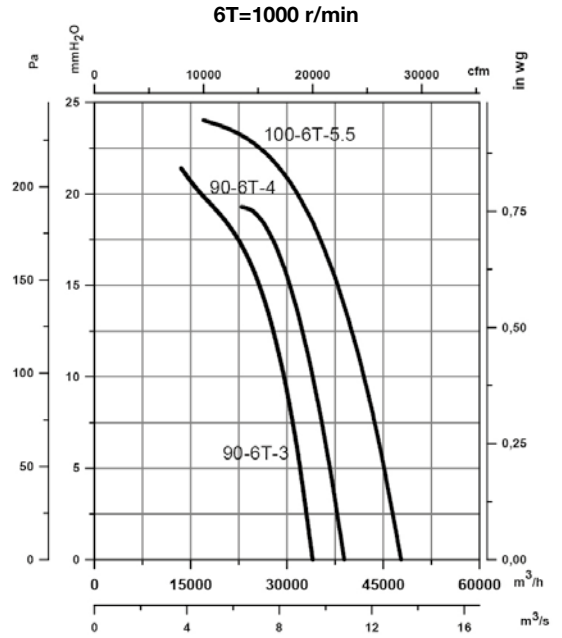
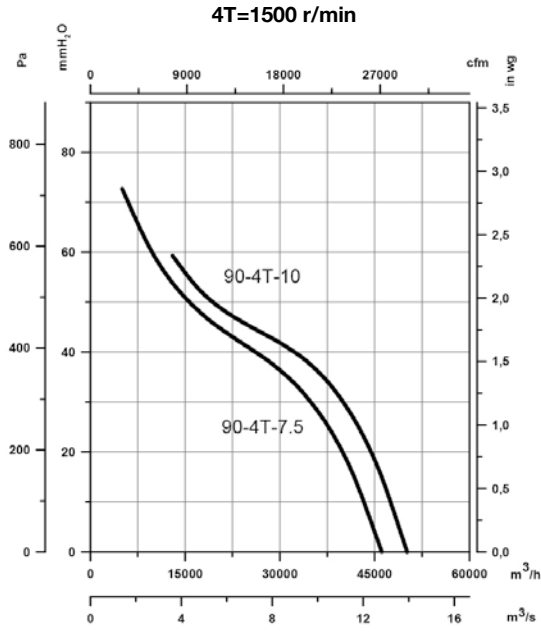

Accessories



INT



IAT



CABLE BOX



C2V



VSD3/A-RFT
- VSD1/A-RFM



CENTRAL CO



AET



P-400



RT



R/THT



BAC



PS



ACE ACE/400



S

THT/HATCH



400°C/2h and 300°C/2h rated dynamic discharge system with motorised opening function, fitted with roof mounted extractor, for smoke exhaust in the event of fire



Dynamic discharge systems with roof-mounted extract fans and motorised opening function. Specially designed for the fast, effective exhaust of harmful smoke and gases in the event of fire. Suitable for installation in industrial or commercial buildings. Approved in accordance with standard EN 12101-3, with F400 and F300 certificate. The rapid smoke extract permits the efficient intervention of fire fighters, fast evacuation of people and prevents new sources of fire and greater structural damage to the building. Can also be used for ambient ventilation in the buildings in which it is installed.

Fan:

- An extremely robust structure that is able to withstand severe weather changes.
- Equipment structure made of anti-corrosive galvanised sheet steel.
- Designed to ensure watertightness.
- 100 mm thick thermal insulation for the hatch and 60 mm for the sides.
- Adaptable skirting for correct, easy installation on the roof.
- Maintenance switches for actuator and fan disconnection with auxiliary contacts.
- Roof mounted extract fans with F400 certificate no. 0370-CPR-1827 and F300 certificate no. 0370-CPR-0973.
- Tubular casing in sheet steel with polyester resin anti-corrosive treatment.
- Adjustable cast aluminum impeller.

Opening system:

- Motorised opening arm, with encapsulated IP65 mechanism.
- Supply voltage at 230 V AC 50/60 Hz.
- System reinforced and guaranteed with more than 11,000 cycles.
- Snow load SL 1000.
- Automatic opening by external signal from the control system (fire control panel, smoke detector ...). Control systems not included in the supply.
- Limit switches in both positions (open and closed).

Motor:

- Class H motors for S1 continuous operation and S2 emergency use. With ball bearings and IP55 protection.
- IE3 efficiency motors.
- Three-phase 230/400 V 50 Hz (up to 3 kW) and 400/690 V 50 Hz (powers greater than 3 kW).
- Maximum temperature of air to be carried: S1 -25 °C +40 °C continuous service, also suitable for warm climates with temperatures up to 50 °C. S2 operation, 300 °C/2h, 400 °C/2h.

Finish:

- Anti-corrosive in galvanized steel sheet.

On request:

- Polyester resin anti-corrosive paint finish.
- Motorised opening arms with supply voltage of 24 V DC.
- Protection grille against contact according to UNE-EN ISO 12499 for inlet and/or outlet.

Order code

From size 40 to size 100

THT/HATCH	—	63	—	4T	—	3	—	F400
↓		↓		↓	↘	↓		↓
THT/HATCH: 400°C/2h and 300°C/2h rated dynamic discharge system with motorised opening function, fitted with roof mounted extractor, for smoke exhaust in the event of fire		Impeller diameter in cm		Number of motor poles 2=3000 r/min 50 Hz 4=1500 r/min 50 Hz 6=1000 r/min 50 Hz	T = Three-phase	Motor power (HP)		F300: 300 °C/2h approved F400: 400 °C/2h approved

Order code

Size 125

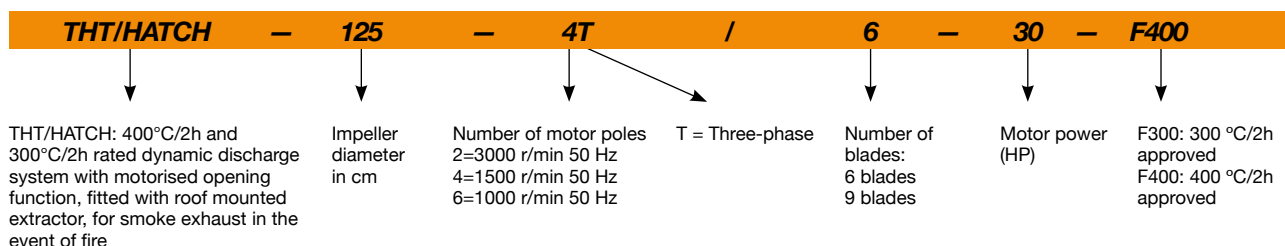

Technical characteristics

Model	Speed (r/min)	Maximum admissible current (A)			Installed power (kW)	Blade tilt angle (°)	Maximum flow rate (m³/h)	Sound pressure level ¹ dB (A)		Approx. weight (Kg)
		230V	400V	690V				Inlet	Exhaust	
THT/HATCH-40-2T-1 IE3	2850	2.76	1.59		0.75	16	6100	62	62	184
THT/HATCH-40-2T-1.5 IE3	2880	3.93	2.26		1.10	20	7040	61	61	188
THT/HATCH-45-2T-2 IE3	2880	4.91	2.84		1.50	16	9400	61	61	193
THT/HATCH-45-2T-3 IE3	2840	7.14	4.13		2.20	22	11325	61	61	194
THT/HATCH-50-2T-4 IE3	2880	9.61	5.52		3.00	16	13860	66	66	206
THT/HATCH-56-2T-5.5 IE3	2870		7.20	4.17	4.00	16	18820	68	68	226
THT/HATCH-56-2T-7.5 IE3	2910		10.10	5.80	5.50	22	22510	68	68	237
THT/HATCH-63-4T-3 IE3	1425	7.86	4.52		2.20	32	22170	58	58	262
THT/HATCH-63-4T-4 IE3	1430	11.01	6.33		3.00	38	24240	59	59	271
THT/HATCH-63-6T-1 IE3	940	3.36	1.93		0.75	38	15890	48	48	252
THT/HATCH-80-4T-3 IE3	1425	7.86	4.52		2.20	12	25460	65	65	280
THT/HATCH-80-4T-4 IE3	1430	11.01	6.33		3.00	16	30270	64	64	289
THT/HATCH-80-4T-5.5 IE3	1440		7.95	4.61	4.00	18	32770	63	63	295
THT/HATCH-80-4T-7.5 IE3	1460		10.40	6.04	5.50	26	39640	63	63	311
THT/HATCH-80-6T-1.5 IE3	945	4.73	2.72		1.10	18	21470	53	53	279
THT/HATCH-80-6T-2 IE3	945	6.25	3.62		1.50	26	25970	54	54	288
THT/HATCH-90-4T-7.5 IE3	1460		10.40	6.04	5.50	18	46140	67	67	392
THT/HATCH-90-4T-10 IE3	1460		14.20	8.17	7.50	22	50140	66	66	403
THT/HATCH-90-4T-15 IE3	1460		20.70	11.99	11.00	30	59390	68	68	456
THT/HATCH-90-6T-3 IE3	950	9.78	5.62		2.20	24	34000	56	56	365
THT/HATCH-90-6T-4 IE3	970	12.80	6.36		3.00	30	38910	59	59	391
THT/HATCH-100-4T-10 IE3	1460		14.20	8.17	7.50	16	57420	69	69	413
THT/HATCH-100-4T-15 IE3	1460		20.70	11.99	11.00	22	66300	69	69	466
THT/HATCH-100-4T-20 IE3	1460		27.80	16.03	15.00	28	76160	70	70	481
THT/HATCH-100-4T/9-25 IE3	1475		35.40	20.39	18.50	26	70620	69	69	535
THT/HATCH-100-4T/9-30 IE3	1475		42.20	24.44	22.00	30	74840	71	71	552
THT/HATCH-100-6T-5.5 IE3	970		8.37	4.82	4.00	26	47780	60	60	413
THT/HATCH-100-6T-7.5 IE3	970		12.30	7.07	5.50	32	53520	62	62	420
THT/HATCH-125-4T/6-25 IE3	1465		35.40	20.39	18.50	14	92550	76	76	746
THT/HATCH-125-4T/6-30 IE3	1470		42.20	24.44	22.00	16	98830	75	75	760
THT/HATCH-125-4T/6-40 IE3	1475		53.30	31.02	30.00	22	117450	75	75	841
THT/HATCH-125-4T/6-50 IE3	1480		66.80	38.70	37.00	26	131050	75	75	889
THT/HATCH-125-4T/9-25 IE3	1465		35.40	20.39	18.50	10	79650	77	77	755
THT/HATCH-125-4T/9-30 IE3	1470		42.20	24.44	22.00	12	88290	76	76	769
THT/HATCH-125-4T/9-40 IE3	1475		53.30	31.02	30.00	16	104040	75	75	850
THT/HATCH-125-4T/9-50 IE3	1480		66.80	38.70	37.00	20	118400	75	75	898
THT/HATCH-125-6T/6-5.5 IE3	970		8.37	4.82	4.00	10	51500	67	67	611
THT/HATCH-125-6T/6-7.5 IE3	970		12.30	7.07	5.50	14	60640	65	65	618
THT/HATCH-125-6T/6-10 IE3	960		15.20	8.83	7.50	20	72650	64	64	643
THT/HATCH-125-6T/6-15 IE3	955		22.50	13.07	11.00	26	85850	64	64	673

Technical characteristics

Model	Speed (r/min)	Maximum admissible current (A)			Installed power (kW)	Blade tilt angle (°)	Maximum flow rate (m³/h)	Sound pressure level ¹ dB (A)		Approx. weight (Kg)
		230V	400V	690V				Inlet	Exhaust	
THT/HATCH-125-6T/6-20 IE3	950		29.00	16.78	15.00	30	92850	66	66	746
THT/HATCH-125-6T/9-10 IE3	960		15.20	8.83	7.50	14	63490	67	67	652
THT/HATCH-125-6T/9-15 IE3	955		22.50	13.07	11.00	20	77550	65	65	682
THT/HATCH-125-6T/9-20 IE3	950		29.00	16.78	15.00	26	92950	65	65	755

¹ The noise level values are pressures in dB(A) measured at a distance of 10 metres in a free field.

Technical characteristics of the dynamic exhaust system based on standards EN-12101-3 and EN-12101-2

Model	Approval (°C)	Motor insulation class	Durability	Temperature room temperature (°C)	Wind load (Pa)	Snow load (Pa)
THT/HATCH	F300 and F400	Class H	RE 11000	-25	WL 200	SL 1000



Erp. (Energy Related Products)

Information on Directive 2009/125/EC can be downloaded from the SODECA website or the QuickFan selector programme.

Acoustic characteristics

Sound power spectrum Lw(A) in dB(A) per Hz frequency band

Values measured at inlet with maximum flow rate

	63	125	250	500	1000	2000	4000	8000
40-2-1	48	64	76	84	89	87	83	76
40-2-1.5	47	63	75	83	88	86	82	75
45-2-2	47	60	74	86	87	86	82	74
45-2-3	47	64	74	81	88	86	83	75
50-2-4	58	74	84	91	92	89	88	89
56-2-5.5	53	66	84	92	94	93	88	81
56-2-7.5	53	66	84	92	94	93	88	81
63-4-3	56	68	77	83	83	83	77	69
63-4-4	57	69	78	84	84	84	78	70
63-6-1	49	59	69	73	74	72	65	57
80-4-3	55	71	84	91	91	88	82	74
80-4-4	54	70	83	90	90	87	81	73
80-4-5.5	53	69	82	89	89	86	80	72
80-4-7.5	53	69	82	89	89	86	80	72
80-6-1.5	53	68	75	78	79	76	70	62
80-6-2	59	69	75	79	80	78	73	65
90-4-7.5	59	75	86	92	93	91	86	78
90-4-10	58	74	85	91	92	90	85	77
90-4-15	60	76	87	93	94	92	87	79
90-6-3	52	67	78	82	82	78	71	63
90-6-4	60	70	80	85	85	82	76	68
100-4-10	64	80	87	94	95	93	89	81
100-4-15	71	83	87	93	94	94	91	83
100-4-20	72	84	88	94	95	95	92	84
100-4/9-25	71	83	87	93	94	94	91	83
100-4/9-30	73	85	89	95	96	96	93	85
100-6-5.5	57	72	82	85	86	83	75	67
100-6-7.5	59	74	84	87	88	85	77	69
125-4/6-25	68	84	95	102	103	101	94	86
125-4/6-30	67	83	94	101	102	100	93	85
125-4/6-40	67	83	94	101	102	100	93	85
125-4/6-50	67	83	94	101	102	100	93	85
125-4/9-25	67	81	94	102	104	101	96	88
125-4/9-30	66	80	93	101	103	100	95	87
125-4/9-40	65	79	92	100	102	99	94	86
125-4/9-50	65	79	92	100	102	99	94	86

Values measured at exhaust with maximum flow rate

	63	125	250	500	1000	2000	4000	8000
40-2-1	48	64	76	84	89	87	83	76
40-2-1.5	47	63	75	83	88	86	82	75
45-2-2	47	60	74	86	87	86	82	74
45-2-3	47	64	74	81	88	86	83	75
50-2-4	58	74	84	91	92	89	88	89
56-2-5.5	53	66	84	92	94	93	88	81
56-2-7.5	53	66	84	92	94	93	88	81
63-4-3	56	68	77	83	83	83	77	69
63-4-4	57	69	78	84	84	84	78	70
63-6-1	49	59	69	73	74	72	65	57
80-4-3	55	71	84	91	91	88	82	74
80-4-4	54	70	83	90	90	87	81	73
80-4-5.5	53	69	82	89	89	86	80	72
80-4-7.5	53	69	82	89	89	86	80	72
80-6-1.5	53	68	75	78	79	76	70	62
80-6-2	59	69	75	79	80	78	73	65
90-4-7.5	59	75	86	92	93	91	86	78
90-4-10	58	74	85	91	92	90	85	77
90-4-15	60	76	87	93	94	92	87	79
90-6-3	52	67	78	82	82	78	71	63
90-6-4	60	70	80	85	85	82	76	68
100-4-10	64	80	87	94	95	93	89	81
100-4-15	71	83	87	93	94	94	91	83
100-4-20	72	84	88	94	95	95	92	84
100-4/9-25	71	83	87	93	94	94	91	83
100-4/9-30	73	85	89	95	96	96	93	85
100-6-5.5	57	72	82	85	86	83	75	67
100-6-7.5	59	74	84	87	88	85	77	69
125-4/6-25	68	84	95	102	103	101	94	86
125-4/6-30	67	83	94	101	102	100	93	85
125-4/6-40	67	83	94	101	102	100	93	85
125-4/6-50	67	83	94	101	102	100	93	85
125-4/9-25	67	81	94	102	104	101	96	88
125-4/9-30	66	80	93	101	103	100	95	87
125-4/9-40	65	79	92	100	102	99	94	86
125-4/9-50	65	79	92	100	102	99	94	86

Acoustic characteristics

Sound power spectrum Lw(A) in dB(A) per Hz frequency band

Values measured at inlet with maximum flow rate

	63	125	250	500	1000	2000	4000	8000
125-6/6-5.5	64	79	89	92	93	90	85	77
125-6/6-7.5	62	77	87	90	91	88	83	75
125-6/6-10	61	76	86	89	90	87	82	74
125-6/6-15	61	76	86	89	90	87	82	74
125-6/6-20	63	78	88	91	92	89	84	76
125-6/9-10	61	76	87	93	94	88	84	77
125-6/9-15	59	74	85	91	92	86	82	75
125-6/9-20	59	74	85	91	92	86	82	75

Values measured at exhaust with maximum flow rate

	63	125	250	500	1000	2000	4000	8000
125-6/6-5.5	64	79	89	92	93	90	85	77
125-6/6-7.5	62	77	87	90	91	88	83	75
125-6/6-10	61	76	86	89	90	87	82	74
125-6/6-15	61	76	86	89	90	87	82	74
125-6/6-20	63	78	88	91	92	89	84	76
125-6/9-10	61	76	87	93	94	88	84	77
125-6/9-15	59	74	85	91	92	86	82	75
125-6/9-20	59	74	85	91	92	86	82	75

Dimensions mm

THT/HATCH-40...100

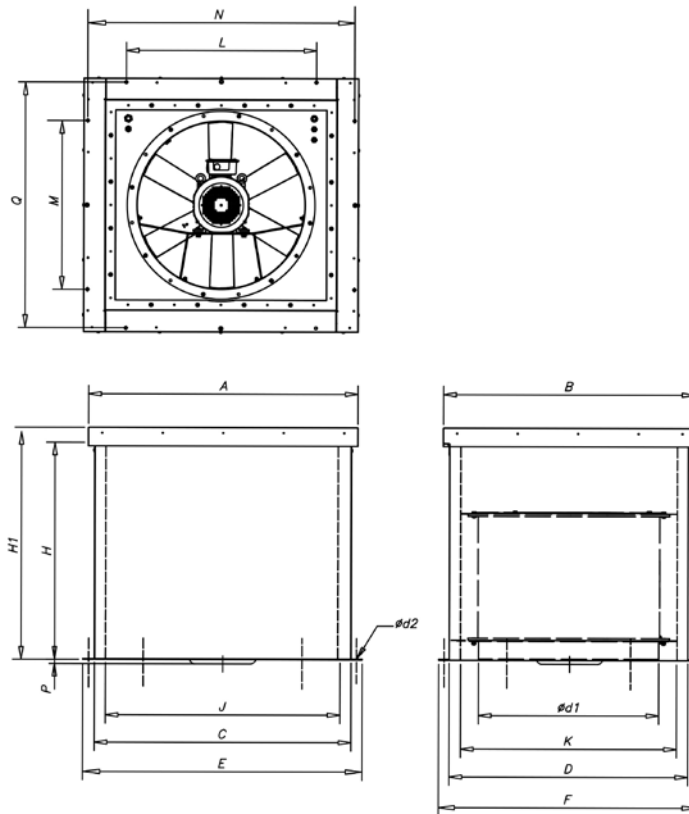

	A	B	C	D	ød1	ød2	E	F	H	H1	J	K	L	M	N	P	Q
THT/HATCH-40	1100	1000	1020	920	400	13	1100	1000	900	1000	900	800	700	600	1065	-	965
THT/HATCH-45	1100	1000	1020	920	450	13	1100	1000	900	1000	900	800	700	600	1065	-	965
THT/HATCH-50	1100	1000	1020	920	500	13	1100	1000	900	1000	900	800	700	600	1065	-	965
THT/HATCH-56	1100	1000	1020	920	560	13	1100	1000	900	1000	900	800	700	600	1065	-	965
THT/HATCH-63	1300	1200	1220	1120	630	13	1300	1200	900	1000	1100	1000	900	800	1265	-	1165
THT/HATCH-80	1300	1200	1220	1120	800	13	1300	1200	900	1000	1100	1000	900	800	1265	-	1165
THT/HATCH-90	1500	1400	1420	1320	900	13	1500	1400	900	1000	1300	1200	1100	1000	1465	-	1365
THT/HATCH-90-4T-15	1500	1400	1420	1320	900	13	1500	1400	900	1000	1300	1200	1100	1000	1465	38	1365
THT/HATCH-100	1500	1400	1420	1320	1000	13	1500	1400	900	1000	1300	1200	1100	1000	1465	-	1365
THT/HATCH-100-4T-15	1500	1400	1420	1320	1000	13	1500	1400	900	1000	1300	1200	1100	1000	1465	80	1365
THT/HATCH-100-4T-20	1500	1400	1420	1320	1000	13	1500	1400	900	1000	1300	1200	1100	1000	1465	80	1365
THT/HATCH-100-4T/9-25	1500	1400	1420	1320	1000	13	1500	1400	900	1000	1300	1200	1100	1000	1465	125	1365
THT/HATCH-100-4T/9-30	1500	1400	1420	1320	1000	13	1500	1400	900	1000	1300	1200	1100	1000	1465	125	1365

Dimensions mm

THT/HATCH-125

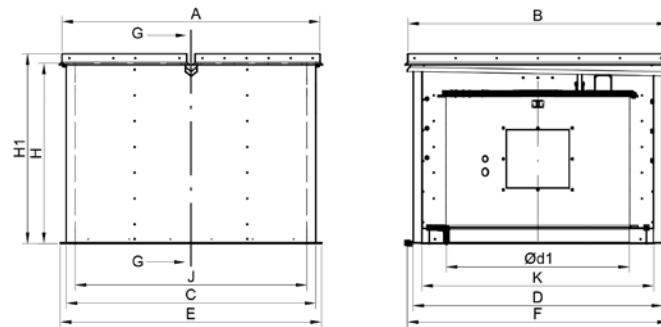

	A	B	C	D	ød1	E	F	H	H1	J	K
THT/HATCH-125	1750	1775	1700	1700	1245	1780	1780	1230	1330	1580	1580

Installation diagram

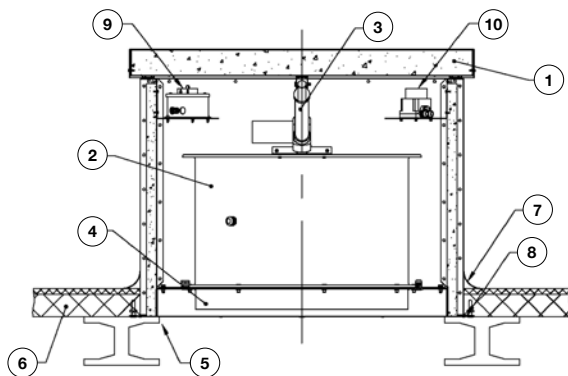

1. THT/HATCH box
2. THT fan
3. Motorised arm (230 V AC or 24 V DC x2)
4. Connection flange in inlet conduit
5. Roof opening
6. Roof
7. Protection against water entry
8. Direct assembly using the adjustable baseboard
9. Motor safety switch
10. Actuator safety switch

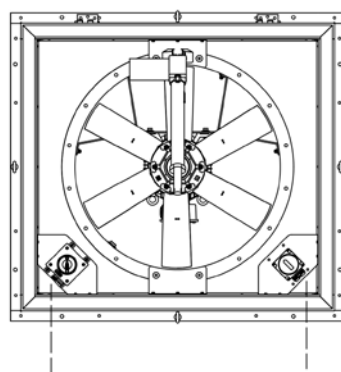

--- Pre-installed by the manufacturer

Note: For motors with powers greater than 5.5 kW it is advisable to use an electronic starter.

Motor power supply
3x400 V 50 Hz

Actuator power supply
1x230 V 50 Hz or 24 V DC

Characteristic curves

Q= Flow rate in m³/h, m³/s and cfm

Pe= Static pressure in mm H₂O, Pa and in wg

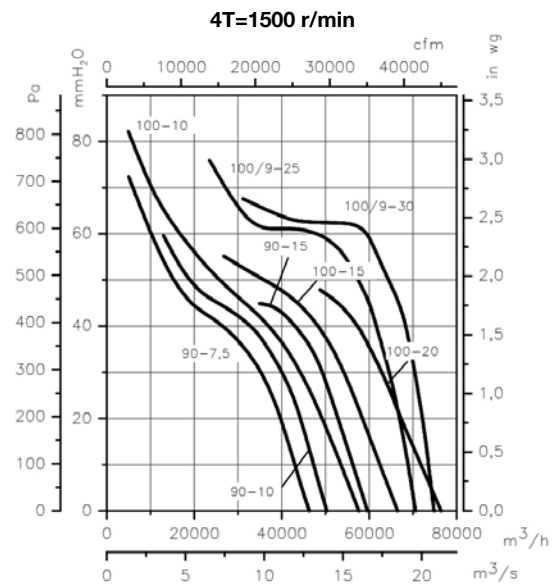
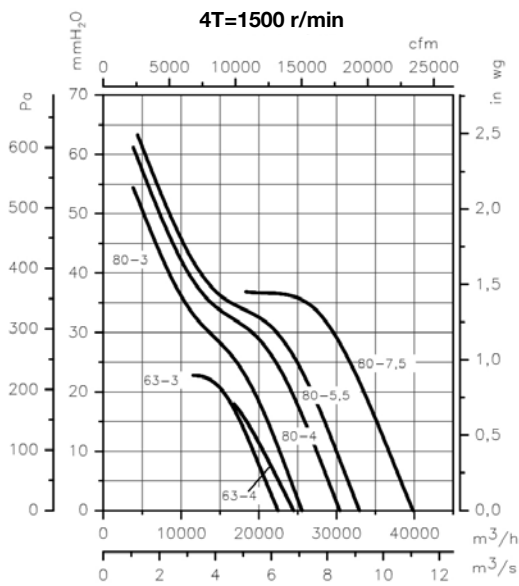
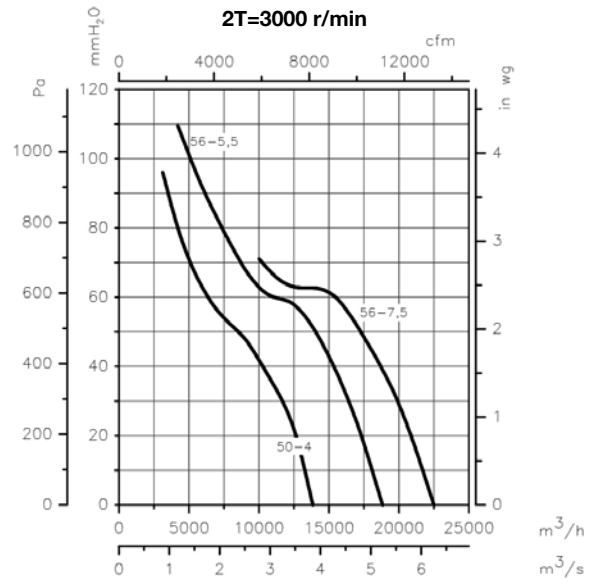
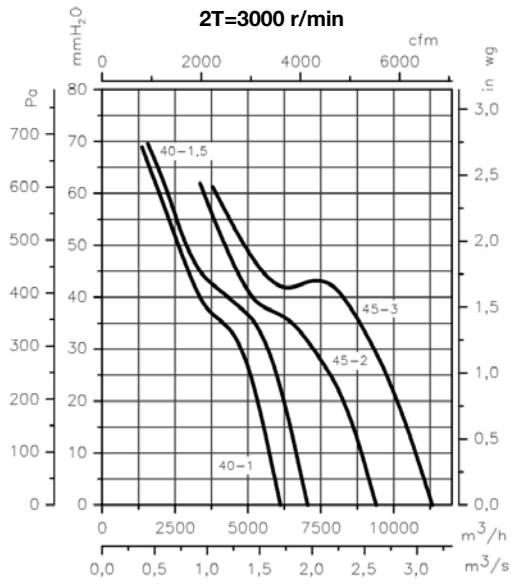

Characteristic curves

Q= Flow rate in m³/h, m³/s and cfm

Pe= Static pressure in mm H₂O, Pa and inwg

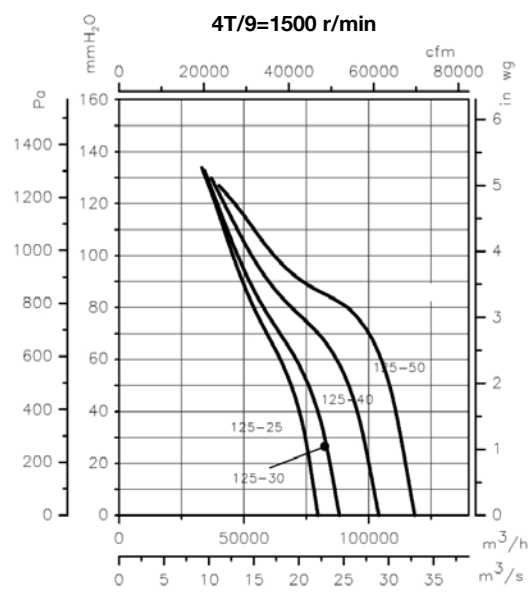
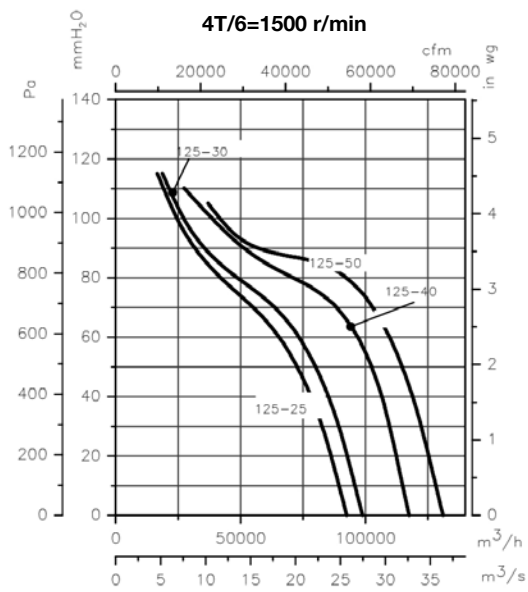
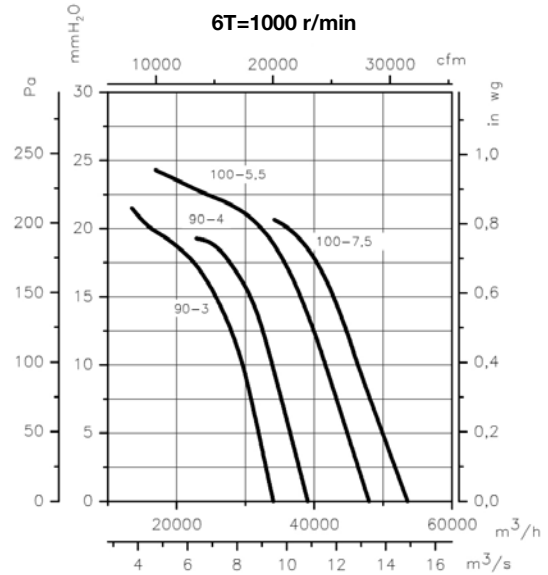
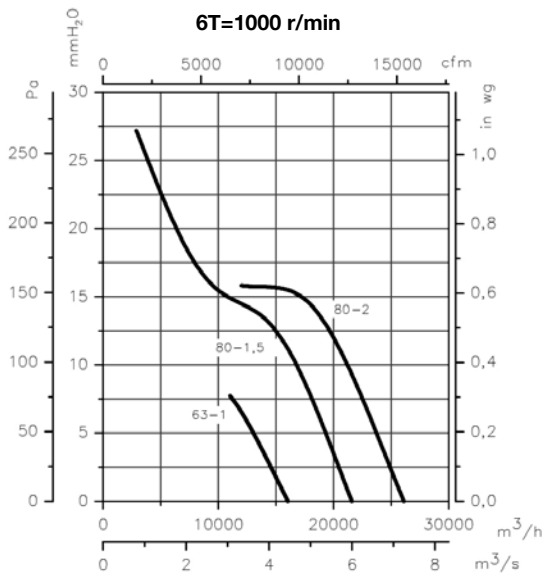

Characteristic curves

Q= Flow rate in m³/h, m³/s and cfm

Pe= Static pressure in mm H₂O, Pa and inwg

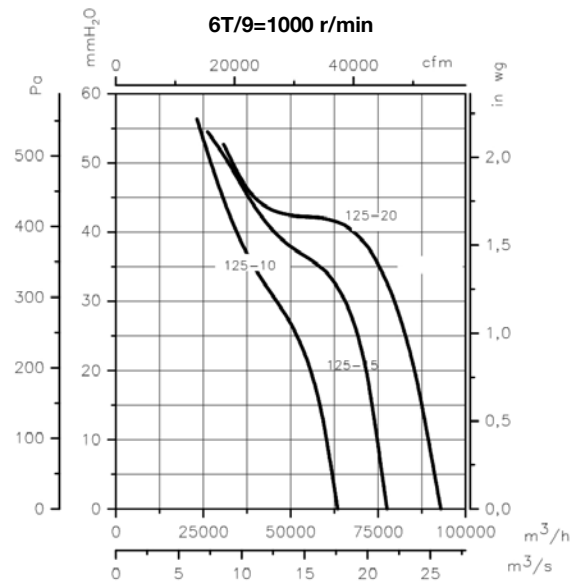
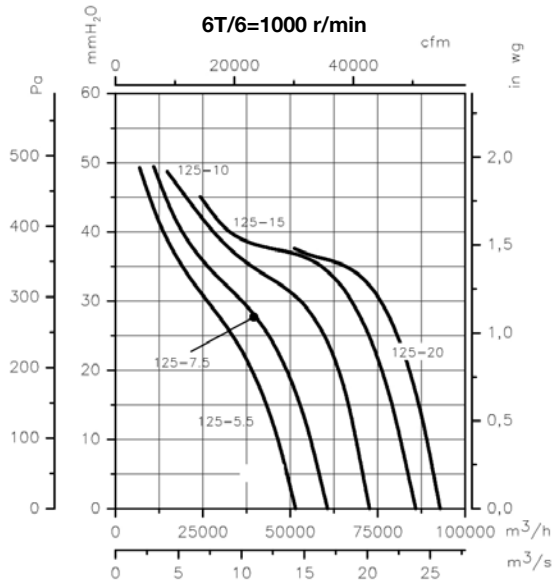

CJTHT/PLUS

400 °C/2h and 300 °C/2h axial exhaust fan units with built-in acoustic attenuator



Extraction units with axial fans to work immersed in fire risk areas.

Fan:

- Fan with tubular sheet steel casing.
- Galvanised sheet steel structure with thermal insulation and acoustic insulation.
- Variable angle impeller made of cast aluminium.
- Approved in accordance with standard EN 12101-3, with certifications no.: 0370- CPR-0312 (F400) and 0370-CPR-0974 (F300).

Motor:

- Class H motors for S1 continuous operation and S2 emergency use. With ball bearings, IP55 protection and 1 or 2 speeds, depending on model.
- Motors with IE3 efficiency for powers equal to or greater than 0.75 kW, except single-phase, 2-speed and 8-pole.
- Three-phase 230/400 V 50 Hz (up to 3 kW) and 400/690 V 50 Hz (powers greater than 3 kW).

- Maximum temperature of air to be carried: S1 -20 °C +40 °C continuous service, also suitable for warm climates with temperatures up to 50 °C. S2 operation, 300 °C/2h, 400 °C/2h.

Finish:

- Fan: anti-corrosive in polyester resin polymerized at 190 °C, after degreasing with phosphate-free nanotechnological treatment.
- Box: anti-corrosive in galvanised sheet steel.

Available versions:

- CJTHT: axial fans with acoustically insulated boxes.
- CJTHT/ATEX: axial fans with acoustically insulated boxes and ATEX certification, category 3 Ex II3G for zone 2 (only 400 °C/2h and 300 °C/2h).
- CJTHT/PLUS Axial fans with acoustic attenuators.

On request:

- Airflow direction from impeller to motor.
- 100% reversible impellers.

Order code

CJTHT/PLUS – 56 – 4T – 2 – F400

CJTHT/PLUS: 400 °C/2h and 300 °C/2h axial exhaust fan units with built-in acoustic attenuator

Impeller diameter in cm

Number of motor poles
2=3000 r/min 50 Hz
4=1500 r/min 50 Hz
6=1000 r/min 50 Hz
8=750 r/min 50 Hz
12=500 r/min 50 Hz

T = Three-phase

Motor power (HP)

F300: 300 °C/2h approved
F400: 400 °C/2h approved

Technical characteristics

Model	Speed (r/min)	Maximum admissible current (A)			Installed power (kW)	Blade tilt angle (°)	Maximum flow rate (m³/h)	Sound pressure level ¹ dB (A)	Approx. weight (Kg)
		230V	400V	690V					
CJTHT/PLUS-40-2/4T-1.5	2900 / 1435		2.89 / 1.04		1.10 / 0.25	20	7040 / 3480	71 / 56	53
CJTHT/PLUS-40-4T-0.75	1420	2.84	1.64		0.55	32	4800	55	47
CJTHT/PLUS-40-6T-0.75	930	2.90	1.75		0.55	32	3150	46	52
CJTHT/PLUS-40-6/12T-0.75	940 / 455		2.35 / 1.15		0.60 / 0.15	32	3150 / 1520	46 / 31	56
CJTHT/PLUS-45-2/4T-2	2940 / 1465		3.58 / 1.19		1.50 / 0.37	16	9400 / 4680	71 / 56	56
CJTHT/PLUS-45-4T-0.75	1420	2.84	1.64		0.55	36	7450	58	49
CJTHT/PLUS-45-6T-0.75	930	2.90	1.75		0.55	30	4450	48	53
CJTHT/PLUS-45-6/12T-0.75	940 / 455		2.35 / 1.15		0.60 / 0.15	30	4450 / 2150	48 / 33	58
CJTHT/PLUS-50-4T-0.75	1420	2.84	1.64		0.55	22	8392	60	50

Technical characteristics

Model	Speed (r/min)	Maximum admissible current (A)			Installed power (kW)	Blade tilt angle (°)	Maximum flow rate (m³/h)	Sound pressure level¹ dB (A) Inlet	Approx. weight (Kg)
		230V	400V	690V					
CJTHT/PLUS-50-6T-0.75	930	2.90	1.75		0.55	32	7000	52	55
CJTHT/PLUS-56-4T-1 IE3	1430	3.08	1.79		0.75	22	11250	63	62
CJTHT/PLUS-56-4T-1.5 IE3	1420	4.10	2.37		1.10	30	13600	63	64
CJTHT/PLUS-56-4/8T-1.5	1440 / 705		2.69 / 1.12		1.10 / 0.25	30	13600 / 6640	63 / 48	68
CJTHT/PLUS-56-4T-2 IE3	1425	5.89	3.38		1.50	36	15030	64	68
CJTHT/PLUS-56-6T-0.75	930	2.90	1.75		0.55	38	10140	54	64
CJTHT/PLUS-56-6/12T-0.75	940 / 455		2.35 / 1.15		0.60 / 0.15	38	10140 / 4890	54 / 39	68
CJTHT/PLUS-63-4T-1 IE3	1430	3.08	1.79		0.75	14	15190	67	66
CJTHT/PLUS-63-4T-1.5 IE3	1420	4.10	2.37		1.10	20	17800	66	69
CJTHT/PLUS-63-4/8T-1.5	1440 / 705		2.69 / 1.12		1.10 / 0.25	20	17800 / 8680	66 / 51	72
CJTHT/PLUS-63-4T-2 IE3	1425	5.89	3.38		1.50	24	19280	66	72
CJTHT/PLUS-63-4/8T-2	1415 / 715		3.40 / 1.65		1.50 / 0.30	24	19280 / 9740	66 / 52	84
CJTHT/PLUS-63-4T-3 IE3	1435	7.86	4.52		2.20	32	22150	68	78
CJTHT/PLUS-63-4/8T-3	1415 / 700		4.80 / 1.85		2.20 / 0.45	32	22150 / 10920	68 / 53	90
CJTHT/PLUS-63-4T-4 IE3	1430	11.01	6.33		3.00	38	24240	69	87
CJTHT/PLUS-63-4/8T-4	1420 / 710		6.45 / 2.28		3.00 / 0.60	38	24240 / 12070	69 / 54	101
CJTHT/PLUS-63-6T-0.75	930	2.90	1.75		0.55	28	13590	57	68
CJTHT/PLUS-63-6/12T-0.75	940 / 455		2.35 / 1.15		0.60 / 0.15	28	13590 / 6550	57 / 42	72
CJTHT/PLUS-63-6T-1 IE3	940	3.36	1.93		0.75	38	15890	58	72
CJTHT/PLUS-63-6/12T-1	935 / 455		3.75 / 2.76		0.80 / 0.20	38	15890 / 7700	58 / 43	78
CJTHT/PLUS-71-4T-1.5 IE3	1420	4.10	2.37		1.10	12	19480	71	85
CJTHT/PLUS-71-4/8T-1.5	1440 / 705		2.69 / 1.12		1.10 / 0.25	12	19480 / 9500	71 / 56	89
CJTHT/PLUS-71-4T-2 IE3	1425	5.89	3.38		1.50	14	20900	70	89
CJTHT/PLUS-71-4/8T-2	1415 / 715		3.40 / 1.65		1.50 / 0.30	14	20900 / 10560	70 / 56	101
CJTHT/PLUS-71-4T-3 IE3	1435	7.86	4.52		2.20	22	25100	70	95
CJTHT/PLUS-71-4/8T-3	1415 / 700		4.80 / 1.85		2.20 / 0.45	22	25100 / 12370	70 / 55	107
CJTHT/PLUS-71-4T-4 IE3	1430	11.01	6.33		3.00	28	27480	70	104
CJTHT/PLUS-71-4/8T-4	1420 / 710		6.45 / 2.28		3.00 / 0.60	28	27480 / 13680	70 / 55	118
CJTHT/PLUS-71-6T-0.75	930	2.90	1.75		0.55	20	16100	60	85
CJTHT/PLUS-71-6/12T-0.75	940 / 455		2.35 / 1.15		0.60 / 0.15	20	16100 / 7760	60 / 45	89
CJTHT/PLUS-71-6T-1 IE3	940	3.36	1.93		0.75	26	17300	60	88
CJTHT/PLUS-71-6/12T-1	935 / 455		3.75 / 2.76		0.80 / 0.20	26	17300 / 8380	60 / 45	95
CJTHT/PLUS-71-6T-1.5 IE3	945	4.73	2.72		1.10	34	19930	61	94
CJTHT/PLUS-71-6/12T-1.5	940 / 460		3.52 / 2.00		1.20 / 0.30	34	19930 / 9760	61 / 46	102
CJTHT/PLUS-80-4T-3 IE3	1435	7.86	4.52		2.20	12	25450	75	103
CJTHT/PLUS-80-4/8T-3	1415 / 700		4.80 / 1.85		2.20 / 0.45	12	25450 / 12550	75 / 60	115
CJTHT/PLUS-80-4T-4 IE3	1430	11.01	6.33		3.00	16	30250	74	112
CJTHT/PLUS-80-4/8T-4	1420 / 710		6.45 / 2.28		3.00 / 0.60	16	30250 / 15060	74 / 59	125
CJTHT/PLUS-80-4T-5.5 IE3	1440		7.95	4.61	4.00	18	32750	73	118
CJTHT/PLUS-80-4/8T-5.5	1450 / 715		7.88 / 2.87		3.80 / 1.00	18	32750 / 16150	73 / 58	153
CJTHT/PLUS-80-6T-1.5 IE3	945	4.73	2.72		1.10	18	21450	63	102
CJTHT/PLUS-80-6/12T-1.5	940 / 460		3.52 / 2.00		1.20 / 0.30	18	21450 / 10500	63 / 48	110
CJTHT/PLUS-80-6T-2 IE3	945	6.25	3.62		1.50	26	25950	64	111
CJTHT/PLUS-80-6/12T-2	960 / 470		4.46 / 3.43		1.60 / 0.40	26	25950 / 12700	64 / 49	115
CJTHT/PLUS-80-6T-3 IE3	950	9.78	5.62		2.20	32	29930	65	118
CJTHT/PLUS-80-6/12T-3	940 / 475		5.62 / 3.32		2.20 / 0.55	32	29930 / 15120	65 / 51	124
CJTHT/PLUS-80-8T-0.75	700	3.48	2.00		0.55	20	17540	57	95
CJTHT/PLUS-80-8T-1	710	5.06	2.92		0.75	28	20650	58	102
CJTHT/PLUS-90-4T-4 IE3	1430	11.01	6.33		3.00	8	33580	79	136
CJTHT/PLUS-90-4/8T-4	1420 / 710		6.45 / 2.28		3.00 / 0.60	8	33580 / 16720	79 / 64	149
CJTHT/PLUS-90-4T-5.5 IE3	1440		7.95	4.61	4.00	12	38890	78	142
CJTHT/PLUS-90-4/8T-5.5	1450 / 715		7.88 / 2.87		3.80 / 1.00	12	38890 / 19170	78 / 63	177
CJTHT/PLUS-90-4T-7.5 IE3	1430		10.40	6.04	5.50	18	46140	77	168
CJTHT/PLUS-90-4/8T-7.5	1455 / 725		11.40 / 3.86		5.50 / 1.10	18	46140 / 22910	77 / 62	182
CJTHT/PLUS-90-4T-10 IE3	1460		14.20	8.17	7.50	22	50140	76	179

Technical characteristics

Model	Speed (r/min)	Maximum admissible current (A)			Installed power (kW)	Blade tilt angle (°)	Maximum flow rate (m³/h)	Sound pressure level¹ dB (A)		Approx. weight (Kg)
		230V	400V	690V				Inlet		
CJTHT/PLUS-90-4/8T-10	1455 / 725		15.10 / 5.16		7.50 / 1.50	22	50140 / 24900	76 / 61	182	
CJTHT/PLUS-90-6T-2 IE3	945	6.25	3.62		1.50	16	28780	66	135	
CJTHT/PLUS-90-6/12T-2	960 / 470		4.46 / 3.43		1.60 / 0.40	16	28780 / 14090	66 / 51	139	
CJTHT/PLUS-90-6T-3 IE3	950	9.78	5.62		2.20	24	34000	66	142	
CJTHT/PLUS-90-6/12T-3	940 / 475		5.62 / 3.32		2.20 / 0.55	24	34000 / 17180	66 / 52	148	
CJTHT/PLUS-90-6T-4 IE3	945	12.80	6.36		3.00	30	38900	69	166	
CJTHT/PLUS-90-6/12T-4	970 / 485		7.37 / 3.53		2.80 / 0.70	30	38900 / 19450	69 / 54	168	
CJTHT/PLUS-90-8T-1	710	5.06	2.92		0.75	18	22900	60	126	
CJTHT/PLUS-90-8T-2	700	7.32	4.21		1.50	30	29490	63	142	
CJTHT/PLUS-90-8T-3	705	9.30	5.35		2.20	32	30850	64	158	
CJTHT/PLUS-100-4T-7.5 IE3	1430		10.40	6.04	5.50	10	46850	82	176	
CJTHT/PLUS-100-4/8T-7.5	1455 / 725		11.40 / 3.86		5.50 / 1.10	10	46850 / 23260	82 / 67	190	
CJTHT/PLUS-100-4T-10 IE3	1460		14.20	8.17	7.50	16	57400	79	187	
CJTHT/PLUS-100-4/8T-10	1455 / 725		15.10 / 5.16		7.50 / 1.50	14	54710 / 27170	80 / 65	190	
CJTHT/PLUS-100-4T-15 IE3	1455		20.70	11.99	11.00	22	66300	79	231	
CJTHT/PLUS-100-4/8T-15	1470 / 730		20.70 / 7.19		11.00 / 3.00	22	66300 / 32880	79 / 64	231	
CJTHT/PLUS-100-4T-20 IE3	1460		27.80	16.03	15.00	28	76150	80	246	
CJTHT/PLUS-100-4/8T-20	1470 / 725		31.72 / 11.75		15.00 / 3.80	28	76150 / 37560	80 / 65	246	
CJTHT/PLUS-100-4T/9-15 IE3	1460		20.70	11.99	11.00	18	55340	80	231	
CJTHT/PLUS-100-4T/9-20 IE3	1460		27.80	16.03	15.00	22	63260	80	240	
CJTHT/PLUS-100-4T/9-25 IE3	1475		35.40	20.39	18.50	26	70625	80	280	
CJTHT/PLUS-100-4T/9-30 IE3	1475		42.20	24.44	22.00	30	74845	82	288	
CJTHT/PLUS-100-6T-3 IE3	950	9.78	5.62		2.20	16	37600	70	150	
CJTHT/PLUS-100-6/12T-3	940 / 475		5.62 / 3.32		2.20 / 0.55	16	37600 / 18990	70 / 56	156	
CJTHT/PLUS-100-6T-4 IE3	945	12.80	6.36		3.00	20	41150	69	175	
CJTHT/PLUS-100-6/12T-4	970 / 485		7.37 / 3.53		2.80 / 0.70	20	41150 / 20580	69 / 54	176	
CJTHT/PLUS-100-6T-5.5 IE3	970		8.37	4.82	4.00	26	47780	70	187	
CJTHT/PLUS-100-6T/9-5.5 IE3	970		11.00	6.35	4.00	20	39020	70	201	
CJTHT/PLUS-100-6T/9-7.5 IE3	970		12.30	7.07	5.50	26	46765	71	205	
CJTHT/PLUS-100-6T/9-10 IE3	970		15.20	8.83	7.50	34	52255	74	230	

1 The noise level values are pressures in dB(A) measured at a distance of 3 metres in a free field.



Erp. (Energy Related Products)

Information on Directive 2009/125/EC can be downloaded from the SODECA website or the QuickFan selector programme.

Acoustic characteristics

Sound power spectrum Lw(A) in dB(A) per Hz frequency band
Values measured at inlet with maximum flow rate

	63	125	250	500	1000	2000	4000	8000		63	125	250	500	1000	2000	4000	8000
40-2-1.5	47	63	75	83	88	86	82	75	56-4-1.5	51	63	72	78	78	78	72	64
40-4-1.5 (2V)	32	48	60	68	73	71	67	60	56-8-1.5 (2V)	35	47	56	62	62	62	56	48
40-4-0.75	37	53	63	70	71	68	67	68	56-4-2	52	64	73	79	79	79	73	65
40-6-0.75	28	44	54	61	62	59	58	59	56-6-0.75	45	55	65	69	70	68	61	53
40-12-0.75 (2V)	12	28	38	45	46	43	42	43	56-12-0.75 (2V)	29	39	49	53	54	52	45	37
45-2-2	47	60	74	86	87	86	82	74	63-4-1	48	64	76	82	84	81	74	66
45-4-2 (2V)	32	45	59	71	72	71	67	59	63-4-1.5	47	63	75	81	83	80	73	65
45-4-0.75	47	59	67	73	73	73	68	60	63-8-1.5 (2V)	31	47	59	65	67	64	57	49
45-6-0.75	37	49	57	63	63	63	58	50	63-4-2	54	66	75	81	81	81	75	67
45-12-0.75 (2V)	21	33	41	47	47	47	42	34	63-8-2 (2V)	39	51	60	66	66	66	60	52
50-4-0.75	49	61	69	75	75	75	70	62	63-4-3	56	68	77	83	83	83	77	69
50-6-0.75	41	53	61	67	67	67	62	54	63-8-3 (2V)	41	53	62	68	68	68	62	54
56-4-1	51	63	72	78	78	78	72	64	63-4-4	57	69	78	84	84	84	78	70

Acoustic characteristics

Sound power spectrum Lw(A) in dB(A) per Hz frequency band
Values measured at inlet with maximum flow rate

	63	125	250	500	1000	2000	4000	8000		63	125	250	500	1000	2000	4000	8000
63-8-4 (2V)	42	54	63	69	69	69	63	55	90-4-5.5	60	76	87	93	94	92	87	79
63-6-0.75	48	58	68	72	73	71	64	56	90-8-5.5 (2V)	45	61	72	78	79	77	72	64
63-12-0.75 (2V)	32	42	52	56	57	55	48	40	90-4-7.5	59	75	86	92	93	91	86	78
63-6-1	49	59	69	73	74	72	65	57	90-8-7.5 (2V)	44	60	71	77	78	76	71	63
63-12-1 (2V)	32	42	52	56	57	55	48	40	90-4-10	58	74	85	91	92	90	85	77
71-4-1.5	57	73	80	86	86	86	82	74	90-8-10 (2V)	43	59	70	76	77	75	70	62
71-8-1.5 (2V)	41	57	64	70	70	70	66	58	90-6-2	52	67	78	82	82	78	71	63
71-4-2	56	72	79	85	85	85	81	73	90-12-2 (2V)	36	51	62	66	66	62	55	47
71-8-2 (2V)	41	57	64	70	70	70	66	58	90-6-3	52	67	78	82	82	78	71	63
71-4-3	56	72	79	85	85	85	81	73	90-12-3 (2V)	37	52	63	67	67	63	56	48
71-8-3 (2V)	41	57	64	70	70	70	66	58	90-6-4	60	70	80	85	85	82	76	68
71-4-4	63	75	79	85	85	86	83	75	90-12-4 (2V)	45	55	65	70	70	67	61	53
71-8-4 (2V)	48	60	64	70	70	71	68	60	90-8-1	42	63	70	75	78	74	67	56
71-6-0.75	46	53	73	76	76	71	63	55	90-8-2	51	66	73	78	81	77	70	59
71-12-0.75 (2V)	30	37	57	60	60	55	47	39	90-8-3	53	67	74	79	82	78	71	60
71-6-1	46	64	73	76	76	71	64	55	100-4-7.5	67	83	90	97	98	96	92	84
71-12-1 (2V)	29	47	56	59	59	54	47	38	100-8-7.5 (2V)	52	68	75	82	83	81	77	69
71-6-1.5	47	65	74	77	77	72	65	56	100-4-10	65	81	88	95	96	94	90	82
71-12-1.5 (2V)	32	50	59	62	62	57	50	41	100-8-10 (2V)	50	66	73	80	81	79	75	67
80-4-3	55	71	84	91	91	88	82	74	100-4-15	71	83	87	93	94	94	91	83
80-8-3 (2V)	40	56	69	76	76	73	67	59	100-8-15 (2V)	56	68	72	78	79	79	76	68
80-4-4	54	70	83	90	90	87	81	73	100-4-20	72	84	88	94	95	95	92	84
80-8-4 (2V)	39	55	68	75	75	72	66	58	100-8-20 (2V)	57	69	73	79	80	80	77	69
80-4-5.5	53	69	82	89	89	86	80	72	100-4-9-15	65	81	88	95	96	94	90	82
80-8-5.5 (2V)	38	54	67	74	74	71	65	57	100-4-9-20	72	84	88	94	95	95	92	84
80-6-1.5	53	68	75	78	79	76	70	62	100-4-9-25	72	84	88	94	95	95	92	84
80-12-1.5 (2V)	38	53	60	63	64	61	55	47	100-4-9-30	74	86	90	96	97	97	94	86
80-6-2	59	69	75	79	80	78	73	65	100-6-3	57	72	82	85	86	83	75	67
80-12-2 (2V)	43	53	59	63	64	62	57	49	100-12-3 (2V)	42	57	67	70	71	68	60	52
80-6-3	60	70	76	80	81	79	74	66	100-6-4	56	71	81	84	85	82	74	66
80-12-3 (2V)	45	55	61	65	66	64	59	51	100-12-4 (2V)	41	56	66	69	70	67	59	51
80-8-0.75	46	59	67	72	74	71	64	53	100-6-5.5	57	72	82	85	86	83	75	67
80-8-1	47	60	68	73	75	72	65	54	100-6/9-5.5	57	72	82	85	86	83	75	67
90-4-4	61	77	88	94	95	93	88	80	100-6/9-7.5	57	72	82	85	86	83	75	67
90-8-4 (2V)	46	62	73	79	80	78	73	65	100-6/9-10	58	73	83	86	87	84	76	68

Dimensions mm

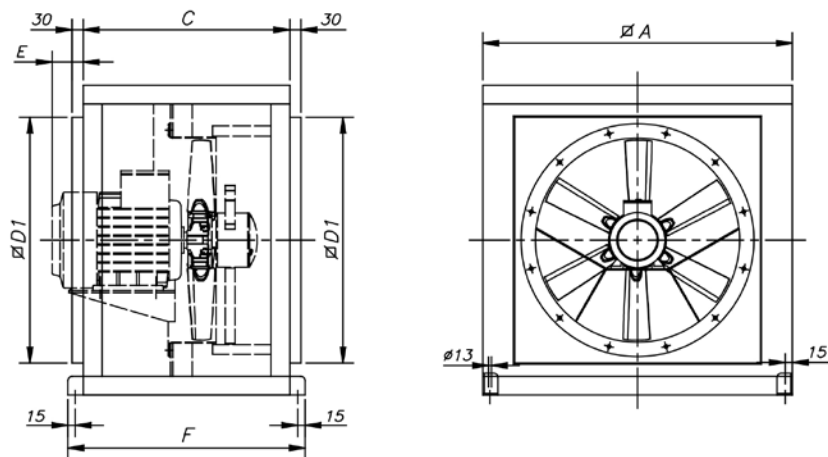

	A	C	øD1	E	F
CJTH/PLUS-40/45/50	700	550	565	-	630
CJTH/PLUS-56/63	825	550	690	140	630
CJTH/PLUS-71/80	1000	650	850	-	730
CJTH/PLUS-90/100	1200	750	1050	-	830

Characteristic curves

See series characteristic curves: THT

Accessories



Configuration with BOXPARK



Control panels for car park ventilation systems with triple purpose: daily ventilation, CO concentration control and smoke extraction in case of fire

Control panels in metal enclosure with all the necessary elements for the management and control of fans in car park ventilation systems, whether they are based on duct networks or impulse fans, for the control of CO concentration levels and smoke extraction in case of fire. Customised panels for all power ratings and number of fans according to project requirements.

More information see BOXPARK series.

Installation examples with BOXPARK

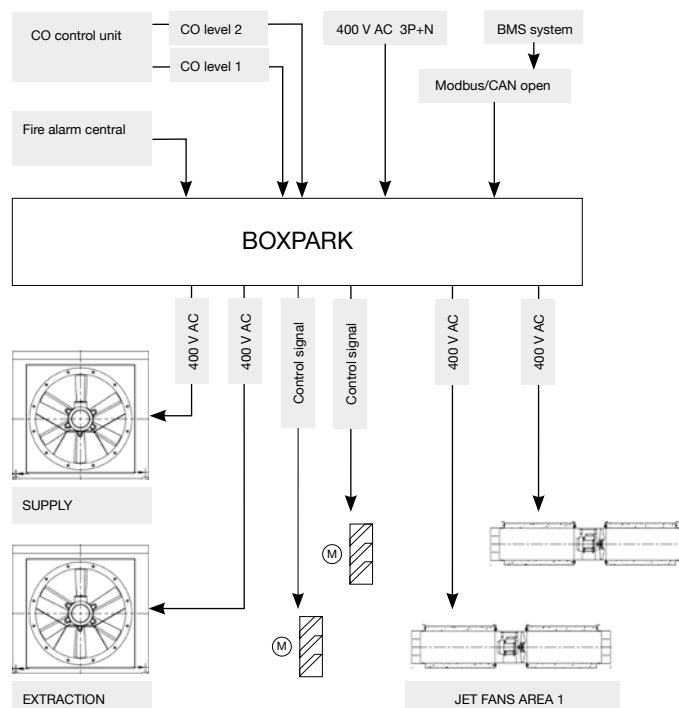

CJTHT

400 °C/2h and 300 °C/2h axial fans with acoustically insulated box



Extraction units with axial fans to work immersed in fire risk areas.

Fan:

- Fan with tubular sheet steel casing.
- Galvanised sheet steel structure with thermal insulation and acoustic insulation.
- Variable angle impeller made of cast aluminium.
- Approved in accordance with standard EN 12101-3, with certifications no.: 0370- CPR-0312 (F400) and 0370-CPR-0974 (F300).

Motor:

- Class H motors for S1 continuous operation and S2 emergency use. With ball bearings, IP55 protection and 1 or 2 speeds, depending on model.
- Motors with IE3 efficiency for powers equal to or greater than 0.75 kW, except single-phase, 2-speed and 8-pole.
- Three-phase 230/400 V 50 Hz (up to 3 kW) and 400/690 V 50 Hz (powers greater than 3 kW).
- Maximum temperature of air to be carried: S1 -20 °C +40 °C continuous service, also suitable for warm climates with temperatures up to 50 °C. S2 operation, 300 °C/2h, 400 °C/2h.

Finish:

- Fan: anti-corrosive in polyester resin polymerized at 190 °C, after degreasing with phosphate-free nanotechnological treatment.
- Box: anti-corrosive in galvanised sheet steel.

Available versions:

- CJTHT: axial fans with acoustically insulated boxes.
- CJTHT/ATEX: axial fans with acoustically insulated boxes and ATEX certification, category 3 Ex II3G for zone 2 (only 400 °C/2h and 300 °C/2h).
- CJTHT/PLUS Axial fans with acoustic attenuators.

On request:

- Airflow direction from impeller to motor.
- 100% reversible impellers.

Order code

From size 40 to size 100

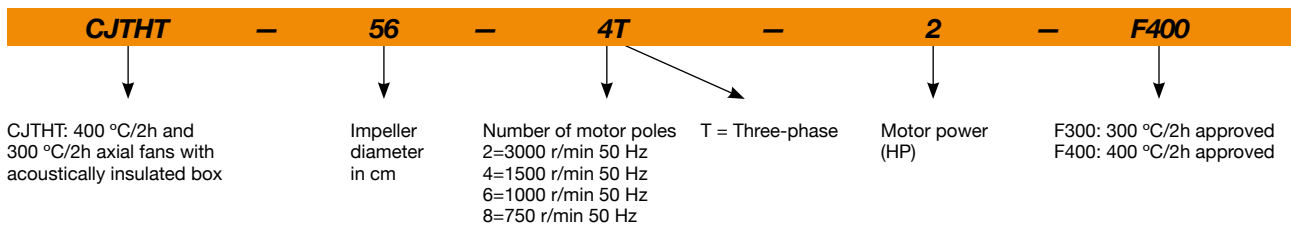

Size 125

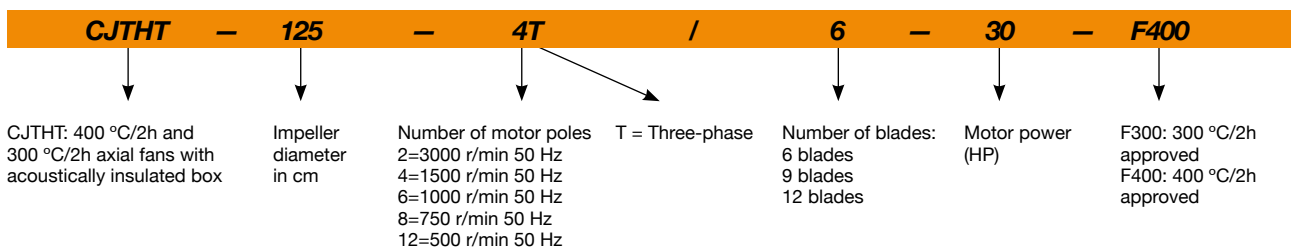

Technical characteristics

Model	Speed (r/min)	Maximum admissible current (A)			Installed power (kW)	Blade tilt angle (°)	Maximum flow rate (m³/h)	Sound pressure level ¹ dB (A)	Approx. weight (Kg)
		230V	400V	690V					
CJTHT-40-2/4T-1.5	2900 / 1435		2.89 / 1.04		1.10 / 0.25	20	7040 / 3480	71 / 56	50
CJTHT-40-4T-0.75	1420	2.84	1.64		0.55	32	4800	55	41
CJTHT-40-6T-0.75	930	2.90	1.75		0.55	32	3150	46	49
CJTHT-40-6/12T-0.75	940 / 455		2.35 / 1.15		0.60 / 0.15	32	3150 / 1520	46 / 31	53
CJTHT-45-2/4T-2	2940 / 1465		3.58 / 1.19		1.50 / 0.37	16	9400 / 4680	71 / 56	53
CJTHT-45-4T-0.75	1420	2.84	1.64		0.55	36	7450	58	43
CJTHT-45-6T-0.75	930	2.90	1.75		0.55	30	4450	48	51
CJTHT-45-6/12T-0.75	940 / 455		2.35 / 1.15		0.60 / 0.15	30	4450 / 2150	48 / 33	55
CJTHT-50-4T-0.75	1420	2.84	1.64		0.55	22	8390	60	48
CJTHT-50-6T-0.75	930	2.90	1.75		0.55	32	7000	52	52
CJTHT-56-4T-1 IE3	1430	3.08	1.79		0.75	22	11250	63	59
CJTHT-56-4T-1.5 IE3	1420	4.10	2.37		1.10	30	13600	63	61
CJTHT-56-4/8T-1.5	1440 / 705		2.69 / 1.12		1.10 / 0.25	30	13600 / 6640	63 / 48	65
CJTHT-56-4T-2 IE3	1425	5.89	3.38		1.50	36	15030	64	63
CJTHT-56-6T-0.75	930	2.90	1.75		0.55	38	10140	54	61
CJTHT-56-6/12T-0.75	940 / 455		2.35 / 1.15		0.60 / 0.15	38	10140 / 4890	54 / 39	65
CJTHT-63-4T-1 IE3	1430	3.08	1.79		0.75	14	15190	67	63
CJTHT-63-4T-1.5 IE3	1420	4.10	2.37		1.10	20	17800	66	66
CJTHT-63-4/8T-1.5	1440 / 705		2.69 / 1.12		1.10 / 0.25	20	17800 / 8680	66 / 51	69
CJTHT-63-4T-2 IE3	1425	5.89	3.38		1.50	24	19280	66	67
CJTHT-63-4/8T-2	1415 / 715		3.40 / 1.65		1.50 / 0.30	24	19280 / 9740	66 / 52	74
CJTHT-63-4T-3 IE3	1435	7.86	4.52		2.20	32	22150	68	73
CJTHT-63-4/8T-3	1415 / 700		4.80 / 1.85		2.20 / 0.45	32	22150 / 10920	68 / 53	87
CJTHT-63-4T-4 IE3	1430	11.01	6.33		3.00	38	24240	69	78
CJTHT-63-4/8T-4	1420 / 710		6.45 / 2.28		3.00 / 0.60	38	24240 / 12070	69 / 54	91
CJTHT-63-6T-0.75	930	2.90	1.75		0.55	28	13590	57	66
CJTHT-63-6/12T-0.75	940 / 455		2.35 / 1.15		0.60 / 0.15	28	13590 / 6550	57 / 42	69
CJTHT-63-6T-1 IE3	940	3.36	1.93		0.75	38	15890	58	67
CJTHT-63-6/12T-1	935 / 455		3.75 / 2.76		0.80 / 0.20	38	15890 / 7700	58 / 43	71
CJTHT-71-4T-1.5 IE3	1420	4.10	2.37		1.10	12	19480	71	82
CJTHT-71-4/8T-1.5	1440 / 705		2.69 / 1.12		1.10 / 0.25	12	19480 / 9500	71 / 56	86
CJTHT-71-4T-2 IE3	1425	5.89	3.38		1.50	14	20900	70	84
CJTHT-71-4/8T-2	1415 / 715		3.40 / 1.65		1.50 / 0.30	14	20900 / 10560	70 / 56	91
CJTHT-71-4T-3 IE3	1435	7.86	4.52		2.20	22	25100	70	90
CJTHT-71-4/8T-3	1415 / 700		4.80 / 1.85		2.20 / 0.45	22	25100 / 12370	70 / 55	103
CJTHT-71-4T-4 IE3	1430	11.01	6.33		3.00	28	27480	70	95
CJTHT-71-4/8T-4	1420 / 710		6.45 / 2.28		3.00 / 0.60	28	27480 / 13680	70 / 55	108
CJTHT-71-6T-0.75	930	2.90	1.75		0.55	20	16100	60	82
CJTHT-71-6/12T-0.75	940 / 455		2.35 / 1.15		0.60 / 0.15	20	16100 / 7760	60 / 45	86
CJTHT-71-6T-1 IE3	940	3.36	1.93		0.75	26	17300	60	84
CJTHT-71-6/12T-1	935 / 455		3.75 / 2.76		0.80 / 0.20	26	17300 / 8380	60 / 45	87
CJTHT-71-6T-1.5 IE3	945	4.73	2.72		1.10	34	19930	61	86
CJTHT-71-6/12T-1.5	940 / 460		3.52 / 2.00		1.20 / 0.30	34	19930 / 9760	61 / 46	97
CJTHT-80-4T-3 IE3	1435	7.86	4.52		2.20	12	25450	75	98
CJTHT-80-4/8T-3	1415 / 700		4.80 / 1.85		2.20 / 0.45	12	25450 / 12550	75 / 60	111
CJTHT-80-4T-4 IE3	1430	11.01	6.33		3.00	16	30250	74	103
CJTHT-80-4/8T-4	1420 / 710		6.45 / 2.28		3.00 / 0.60	16	30250 / 15060	74 / 59	115
CJTHT-80-4T-5.5 IE3	1440		7.95	4.61	4.00	18	32750	73	113
CJTHT-80-4/8T-5.5	1450 / 715		7.88 / 2.87		3.80 / 1.00	18	32750 / 16150	73 / 58	147
CJTHT-80-6T-1.5 IE3	945	4.73	2.72		1.10	18	21450	63	95
CJTHT-80-6/12T-1.5	940 / 460		3.52 / 2.00		1.20 / 0.30	18	21450 / 10500	63 / 48	105
CJTHT-80-6T-2 IE3	945	6.25	3.62		1.50	26	25950	64	99
CJTHT-80-6/12T-2	960 / 470		4.46 / 3.43		1.60 / 0.40	26	25950 / 12700	64 / 49	113
CJTHT-80-6T-3 IE3	950	9.78	5.62		2.20	32	29930	65	113

Technical characteristics

Model	Speed (r/min)	Maximum admissible current (A)			Installed power (kW)	Blade tilt angle (°)	Maximum flow rate (m³/h)	Sound pressure level¹ dB (A)	Approx. weight (Kg)
		230V	400V	690V					
CJTHT-80-6/12T-3	940 / 475		5.62 / 3.32		2.20 / 0.55	32	29930 / 15120	65 / 51	118
CJTHT-80-8T-0.75	700	3.48	2.00		0.55	20	17540	57	99
CJTHT-80-8T-1	710	5.06	2.92		0.75	28	20650	58	111
CJTHT-90-4T-4 IE3	1430	11.01	6.33		3.00	8	33580	79	127
CJTHT-90-4/8T-4	1420 / 710		6.45 / 2.28		3.00 / 0.60	8	33580 / 16720	79 / 64	139
CJTHT-90-4T-5.5 IE3	1440		7.95	4.61	4.00	12	38890	78	137
CJTHT-90-4/8T-5.5	1450 / 715		7.88 / 2.87		3.80 / 1.00	12	38890 / 19170	78 / 63	171
CJTHT-90-4T-7.5 IE3	1430		10.40	6.04	5.50	18	46140	77	171
CJTHT-90-4/8T-7.5	1455 / 725		11.40 / 3.86		5.50 / 1.10	18	46140 / 22910	77 / 62	190
CJTHT-90-4T-10 IE3	1460		14.20	8.17	7.50	22	50140	76	208
CJTHT-90-4/8T-10	1455 / 725		15.10 / 5.16		7.50 / 1.50	22	50140 / 24900	76 / 61	198
CJTHT-90-6T-2 IE3	945	6.25	3.62		1.50	16	28780	66	123
CJTHT-90-6/12T-2	960 / 470		4.46 / 3.43		1.60 / 0.40	16	28780 / 14090	66 / 51	137
CJTHT-90-6T-3 IE3	950	9.78	5.62		2.20	24	34000	66	137
CJTHT-90-6/12T-3	940 / 475		5.62 / 3.32		2.20 / 0.55	24	34000 / 17180	66 / 52	142
CJTHT-90-6T-4 IE3	945	12.80	6.36		3.00	30	38900	69	171
CJTHT-90-6/12T-4	970 / 485		7.37 / 3.53		2.80 / 0.70	30	38900 / 19450	69 / 54	171
CJTHT-90-8T-1	710	5.06	2.92		0.75	18	22900	60	135
CJTHT-90-8T-2	700	7.32	4.21		1.50	30	29490	63	139
CJTHT-90-8T-3	705	9.30	5.35		2.20	32	30850	64	171
CJTHT-100-4T-7.5 IE3	1430		10.40	6.04	5.50	10	46850	82	179
CJTHT-100-4/8T-7.5	1455 / 725		11.40 / 3.86		5.50 / 1.10	10	46850 / 23260	82 / 67	198
CJTHT-100-4T-10 IE3	1460		14.20	8.17	7.50	16	57400	79	216
CJTHT-100-4/8T-10	1455 / 725		15.10 / 5.16		7.50 / 1.50	14	54710 / 27170	80 / 65	206
CJTHT-100-4T-15 IE3	1455		20.70	11.99	11.00	22	66300	79	251
CJTHT-100-4/8T-15	1470 / 730		20.70 / 7.19		11.00 / 3.00	22	66300 / 32880	79 / 64	251
CJTHT-100-4T-20 IE3	1460		27.80	16.03	15.00	28	76150	80	258
CJTHT-100-4/8T-20	1470 / 725		31.72 / 11.75		15.00 / 3.80	28	76150 / 37560	80 / 65	258
CJTHT-100-4T/9-15 IE3	1460		20.70	11.99	11.00	18	55340	80	260
CJTHT-100-4T/9-20 IE3	1460		27.80	16.03	15.00	22	63260	80	268
CJTHT-100-4T/9-25 IE3	1475		35.40	20.39	18.50	26	70620	80	308
CJTHT-100-4T/9-30 IE3	1475		42.20	24.44	22.00	30	74840	82	316
CJTHT-100-6T-3 IE3	950	9.78	5.62		2.20	16	37600	70	145
CJTHT-100-6/12T-3	940 / 475		5.62 / 3.32		2.20 / 0.55	16	37600 / 18990	70 / 56	150
CJTHT-100-6T-4 IE3	945	12.80	6.36		3.00	20	41150	69	179
CJTHT-100-6/12T-4	970 / 485		7.37 / 3.53		2.80 / 0.70	20	41150 / 20580	69 / 54	179
CJTHT-100-6T-5.5 IE3	970		8.37	4.82	4.00	26	47780	70	187
CJTHT-100-6T/9-5.5 IE3	970		11.00	6.35	4.00	20	39020	70	196
CJTHT-100-6T/9-7.5 IE3	970		12.30	7.07	5.50	26	46770	71	200
CJTHT-100-6T/9-10 IE3	970		15.20	8.83	7.50	34	52260	74	225
CJTHT-125-4T/6-20 IE3	1460		27.80	16.03	15.00	10	78600	87	466
CJTHT-125-4/8T/6-20	1470 / 725		31.72 / 11.75		15.00 / 3.80	10	78600 / 38770	87 / 72	485
CJTHT-125-4T/6-25 IE3	1465		35.40	20.39	18.50	14	92550	86	549
CJTHT-125-4/8T/6-27	1470 / 730		39.70 / 14.10		20.00 / 5.00	16	98830 / 48910	85 / 70	557
CJTHT-125-4T/6-30 IE3	1470		42.20	24.44	22.00	16	98830	85	554
CJTHT-125-4/8T/6-37	1475 / 735		54.55 / 18.50		28.00 / 6.50	20	110890 / 55260	85 / 70	633
CJTHT-125-4T/6-40 IE3	1475		53.30	31.02	30.00	22	117450	85	606
CJTHT-125-4T/6-50 IE3	1480		66.80	38.70	37.00	26	131050	85	734
CJTHT-125-4T/6-60 IE3	1475		80.90	46.90	45.00	28	135820	85	767
CJTHT-125-4T/6-75 IE3	1480		98.60	57.20	55.00	34	152100	88	848
CJTHT-125-4T/9-25 IE3	1465		35.40	20.39	18.50	10	79650	87	558
CJTHT-125-4T/9-30 IE3	1470		42.20	24.44	22.00	12	88290	86	563
CJTHT-125-4/8T/9-27	1470 / 730		39.70 / 14.10		20.00 / 5.00	12	88290 / 43690	86 / 71	566
CJTHT-125-4/8T/9-37	1475 / 735		54.55 / 18.50		28.00 / 6.50	16	104040 / 51840	85 / 70	642

Technical characteristics

Model	Speed (r/min)	Maximum admissible current (A)			Installed power (kW)	Blade tilt angle (°)	Maximum flow rate (m³/h)	Sound pressure level¹ dB (A)		Approx. weight (Kg)
		230V	400V	690V				Inlet		
CJTHT-125-4T/9-40 IE3	1475		53.30	31.02	30.00	16	104040	85	615	
CJTHT-125-4T/9-50 IE3	1480		66.80	38.70	37.00	20	118400	85	743	
CJTHT-125-4T/9-60 IE3	1475		80.90	46.90	45.00	24	134970	85	776	
CJTHT-125-4T/9-75 IE3	1480		98.60	57.20	55.00	28	146770	86	857	
CJTHT-125-4T/9-100 IE3	1480		128.00	74.22	75.00	34	158560	88	1018	
CJTHT-125-4T/12-50 IE3	1480		66.80	38.70	37.00	18	101660	86	772	
CJTHT-125-4T/12-60 IE3	1475		80.90	46.90	45.00	20	109180	86	785	
CJTHT-125-4T/12-75 IE3	1480		98.60	57.20	55.00	26	131240	86	866	
CJTHT-125-4T/12-100 IE3	1480		128.00	74.22	75.00	32	154100	88	1036	
CJTHT-125-6T/6-5.5 IE3	970		8.37	4.82	4.00	10	51500	77	402	
CJTHT-125-6T/6-7.5 IE3	970		12.30	7.07	5.50	14	60640	75	410	
CJTHT-125-6/12T/6-7.5	970 / 480		14.50 / 5.17		5.50 / 1.00	14	60640 / 30010	75 / 60	454	
CJTHT-125-6T/6-10 IE3	960		15.20	8.83	7.50	20	72650	74	458	
CJTHT-125-6/12T/6-10	970 / 490		13.60 / 5.69		7.20 / 1.80	20	72650 / 36510	74 / 60	466	
CJTHT-125-6T/6-15 IE3	955		22.50	13.07	11.00	26	85850	74	475	
CJTHT-125-6/12T/6-15	970 / 485		23.10 / 8.41		11.00 / 3.00	26	85850 / 42710	74 / 59	566	
CJTHT-125-6T/6-20 IE3	950		29.00	16.78	15.00	30	92850	76	542	
CJTHT-125-6/12T/6-24	970 / 480		41.60 / 13.21		17.60 / 2.85	34	99650 / 49320	78 / 63	631	
CJTHT-125-6T/9-10 IE3	960		15.20	8.83	7.50	14	63490	77	467	
CJTHT-125-6/12T/9-10	970 / 490		13.60 / 5.69		7.20 / 1.80	14	63490 / 31910	77 / 63	475	
CJTHT-125-6T/9-15 IE3	955		22.50	13.07	11.00	20	77550	75	484	
CJTHT-125-6/12T/9-15	970 / 485		23.10 / 8.41		11.00 / 3.00	20	77550 / 38580	75 / 60	575	
CJTHT-125-6T/9-20 IE3	950		29.00	16.78	15.00	26	92950	75	551	
CJTHT-125-6/12T/9-24	970 / 480		41.60 / 13.21		17.60 / 2.85	30	98500 / 48750	76 / 61	640	
CJTHT-125-6T/9-25 IE3	975		36.10	20.77	18.50	32	101450	77	627	
CJTHT-125-6T/9-30 IE3	975		42.30	24.35	22.00	36	106520	80	638	
CJTHT-125-6T/12-10 IE3	970		15.20	8.83	7.50	12	49630	79	496	
CJTHT-125-6T/12-15 IE3	970		22.50	13.07	11.00	18	67310	77	513	
CJTHT-125-6T/12-20 IE3	970		29.00	16.78	15.00	24	81840	76	580	
CJTHT-125-6T/12-25 IE3	975		36.10	20.77	18.50	30	96770	77	656	
CJTHT-125-6T/12-30 IE3	975		42.30	24.35	22.00	32	102040	78	667	
CJTHT-125-6T/12-40 IE3	985		56.00	32.50	30.00	34	106350	79	782	

1 The noise level values are pressures in dB(A) measured at a distance of 3 metres in a free field.



Erp. (Energy Related Products)

Information on Directive 2009/125/EC can be downloaded from the SODECA website or the QuickFan selector programme.

Acoustic characteristics

Sound power spectrum Lw(A) in dB(A) per Hz frequency band
Values measured at inlet with maximum flow rate

	63	125	250	500	1000	2000	4000	8000		63	125	250	500	1000	2000	4000	8000
40-2-1.5	47	63	75	83	88	86	82	75	50-4-0.75	49	61	69	75	75	75	70	62
40-4-1.5 (2V)	32	48	60	68	73	71	67	60	50-6-0.75	41	53	61	67	67	67	62	54
40-4-0.75	37	53	63	70	71	68	67	68	56-4-1	51	63	72	78	78	78	72	64
40-6-0.75	28	44	54	61	62	59	58	59	56-4-1.5	51	63	72	78	78	78	72	64
40-12-0.75 (2V)	12	28	38	45	46	43	42	43	56-8-1.5 (2V)	35	47	56	62	62	62	56	48
45-2-2	47	60	74	86	87	86	82	74	56-4-2	52	64	73	79	79	79	73	65
45-4-2 (2V)	32	45	59	71	72	71	67	59	56-6-0.75	45	55	65	69	70	68	61	53
45-4-0.75	47	59	67	73	73	73	68	60	56-12-0.75 (2V)	29	39	49	53	54	52	45	37
45-6-0.75	37	49	57	63	63	63	58	50	63-4-1	48	64	76	82	84	81	74	66
45-12-0.75 (2V)	21	33	41	47	47	47	42	34	63-4-1.5	47	63	75	81	83	80	73	65

Acoustic characteristics

Sound power spectrum Lw(A) in dB(A) per Hz frequency band
Values measured at inlet with maximum flow rate

	63	125	250	500	1000	2000	4000	8000		63	125	250	500	1000	2000	4000	8000
63-8-1.5 (2V)	31	47	59	65	67	64	57	49	100-4/9-15	65	81	88	95	96	94	90	82
63-4-2	54	66	75	81	81	81	75	67	100-4/9-20	72	84	88	94	95	95	92	84
63-8-2 (2V)	39	51	60	66	66	66	60	52	100-4/9-25	72	84	88	94	95	95	92	84
63-4-3	56	68	77	83	83	83	77	69	100-4/9-30	74	86	90	96	97	97	94	86
63-8-3 (2V)	41	53	62	68	68	68	62	54	100-6-3	57	72	82	85	86	83	75	67
63-4-4	57	69	78	84	84	84	78	70	100-12-3 (2V)	42	57	67	70	71	68	60	52
63-8-4 (2V)	42	54	63	69	69	69	63	55	100-6-4	56	71	81	84	85	82	74	66
63-6-0.75	48	58	68	72	73	71	64	56	100-12-4 (2V)	41	56	66	69	70	67	59	51
63-12-0.75 (2V)	32	42	52	56	57	55	48	40	100-6-5.5	57	72	82	85	86	83	75	67
63-6-1	49	59	69	73	74	72	65	57	100-6/9-5.5	57	72	82	85	86	83	75	67
63-12-1 (2V)	32	42	52	56	57	55	48	40	100-6/9-7.5	58	73	83	86	87	84	76	68
71-4-1.5	57	73	80	86	86	86	82	74	100-6/9-10	61	76	86	89	90	87	79	71
71-8-1.5 (2V)	41	57	64	70	70	70	66	58	125-4/6-20	69	85	96	103	104	102	95	87
71-4-2	56	72	79	85	85	85	81	73	125-8/6-20 (2V)	54	70	81	88	89	87	80	72
71-8-2 (2V)	41	57	64	70	70	70	66	58	125-4/6-25	68	84	95	102	103	101	94	86
71-4-3	56	72	79	85	85	85	81	73	125-4/6-27	67	83	94	101	102	100	93	85
71-8-3 (2V)	41	57	64	70	70	70	66	58	125-8/6-27 (2V)	52	68	79	86	87	85	78	70
71-4-4	63	75	79	85	85	86	83	75	125-4/6-30	67	83	94	101	102	100	93	85
71-8-4 (2V)	48	60	64	70	70	71	68	60	125-4/6-37	67	83	94	101	102	100	93	85
71-6-0.75	46	53	73	76	76	71	63	55	125-8/6-37 (2V)	52	68	79	86	87	85	78	70
71-12-0.75 (2V)	30	37	57	60	60	55	47	39	125-4/6-40	67	83	94	101	102	100	93	85
71-6-1	46	64	73	76	76	71	64	55	125-4/6-50	67	83	94	101	102	100	93	85
71-12-1 (2V)	29	47	56	59	59	54	47	38	125-4/6-60	67	83	94	101	102	100	93	85
71-6-1.5	47	65	74	77	77	72	65	56	125-4/6-75	70	86	97	104	105	103	96	88
71-12-1.5 (2V)	32	50	59	62	62	57	50	41	125-4/9-25	67	81	94	102	104	101	96	88
80-4-3	55	71	84	91	91	88	82	74	125-4/9-27	66	80	93	101	103	100	95	87
80-8-3 (2V)	40	56	69	76	76	73	67	59	125-8/9-27 (2V)	51	65	78	86	88	85	80	72
80-4-4	54	70	83	90	90	87	81	73	125-4/9-30	66	80	93	101	103	100	95	87
80-8-4 (2V)	39	55	68	75	75	72	66	58	125-4/9-37	65	79	92	100	102	99	94	86
80-4-5.5	53	69	82	89	89	86	80	72	125-8/9-37 (2V)	50	64	77	85	87	84	79	71
80-8-5.5 (2V)	38	54	67	74	74	71	65	57	125-4/9-40	65	79	92	100	102	99	94	86
80-6-1.5	53	68	75	78	79	76	70	62	125-4/9-50	65	79	92	100	102	99	94	86
80-12-1.5 (2V)	38	53	60	63	64	61	55	47	125-4/9-60	73	86	95	99	101	100	96	89
80-6-2	59	69	75	79	80	78	73	65	125-4/9-75	74	87	96	100	102	101	97	90
80-12-2 (2V)	43	53	59	63	64	62	57	49	125-4/9-100	76	89	98	102	104	103	99	92
80-6-3	60	70	76	80	81	79	74	66	125-4/12-50	66	80	93	101	103	100	95	87
80-12-3 (2V)	45	55	61	65	66	64	59	51	125-4/12-60	66	80	93	101	103	100	95	87
80-8-0.75	46	59	67	72	74	71	64	53	125-4/12-75	74	87	96	100	102	101	97	90
80-8-1	47	60	68	73	75	72	65	54	125-4/12-100	76	89	98	102	104	103	99	92
90-4-4	61	77	88	94	95	93	88	80	125-6/6-5.5	64	79	89	92	93	90	85	77
90-8-4 (2V)	46	62	73	79	80	78	73	65	125-6/6-7.5	62	77	87	90	91	88	83	75
90-4-5.5	60	76	87	93	94	92	87	79	125-12/6-7.5 (2V)	47	62	72	75	76	73	68	60
90-8-5.5 (2V)	45	61	72	78	79	77	72	64	125-6/6-10	61	76	86	89	90	87	82	74
90-4-7.5	59	75	86	92	93	91	86	78	125-12/6-10 (2V)	46	61	71	74	75	72	67	59
90-8-7.5 (2V)	44	60	71	77	78	76	71	63	125-6/6-15	61	76	86	89	90	87	82	74
90-4-10	58	74	85	91	92	90	85	77	125-12/6-15 (2V)	45	60	70	73	74	71	66	58
90-8-10 (2V)	43	59	70	76	77	75	70	62	125-6/6-20	63	78	88	91	92	89	84	76
90-6-2	52	67	78	82	82	78	71	63	125-6/6-24	65	80	90	93	94	91	86	78
90-12-2 (2V)	36	51	62	66	66	62	55	47	125-12/6-24 (2V)	50	65	75	78	79	76	71	63
90-6-3	52	67	78	82	82	78	71	63	125-6/9-10	61	76	87	93	94	88	84	77
90-12-3 (2V)	37	52	63	67	67	63	56	48	125-12/9-10 (2V)	46	61	72	78	79	73	69	62
90-6-4	60	70	80	85	85	82	76	68	125-6/9-15	59	74	85	91	92	86	82	75
90-12-4 (2V)	45	55	65	70	70	67	61	53	125-12/9-15 (2V)	43	58	69	75	76	70	66	59
90-8-1	42	63	70	75	78	74	67	56	125-6/9-20	59	74	85	91	92	86	82	75
90-8-2	51	66	73	78	81	77	70	59	125-6/9-24	60	75	86	92	93	87	83	76
90-8-3	53	67	74	79	82	78	71	60	125-12/9-24 (2V)	45	60	71	77	78	72	68	61
100-4-7.5	67	83	90	97	98	96	92	84	125-6/9-25	61	76	87	93	94	88	84	77
100-8-7.5 (2V)	52	68	75	82	83	81	77	69	125-6/9-30	64	79	90	96	97	91	87	80
100-4-10	65	81	88	95	96	94	90	82	125-6/12-10	63	78	89	95	96	90	86	79
100-8-10 (2V)	50	66	73	80	81	79	75	67	125-6/12-15	61	76	87	93	94	88	84	77
100-4-15	71	83	87	93	94	94	91	83	125-6/12-20	60	75	86	92	93	87	83	76
100-8-15 (2V)	56	68	72	78	79	79	76	68	125-6/12-25	61	76	87	93	94	88	84	77
100-4-20	72	84	88	94	95	95	92	84	125-6/12-30	62	77	88	94	95	89	85	78
100-8-20 (2V)	57	69	73	79	80	80	77	69	125-6/12-40	63	78	89	95	96	90	86	79

Dimensions mm

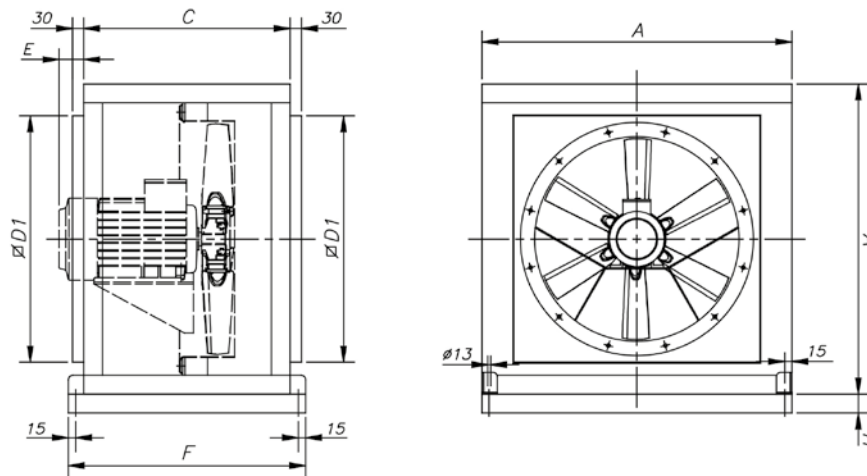

	A	C	ØD1	E	F	H
CJTHT-40/45/50	700	550	565	-	630	-
CJTHT-56/63	825	550	690	140	630	-
CJTHT-71/80	1000	650	850	-	730	-
CJTHT-90/100	1200	750	1050	-	830	-
CJTHT-125 ≤20 HP	1600	1200	1400	-	1280	-
CJTHT-125 >20 HP	1600	1200	1400	123	1280	100

Characteristic curves

See series characteristic curves: THT

Accessories



INT



IAT



CABLE BOX



C2V



VSD3/A-RFT
- VSD1/A-RFM



CENTRAL CO



AET



P-400



BOXPARK

Configuration with BOXPARK



Control panels for car park ventilation systems with triple purpose: daily ventilation, CO concentration control and smoke extraction in case of fire

Control panels in metal enclosure with all the necessary elements for the management and control of fans in car park ventilation systems, whether they are based on duct networks or impulse fans, for the control of CO concentration levels and smoke extraction in case of fire. Customised panels for all power ratings and number of fans according to project requirements.

More information see BOXPARK series.

Installation examples with BOXPARK

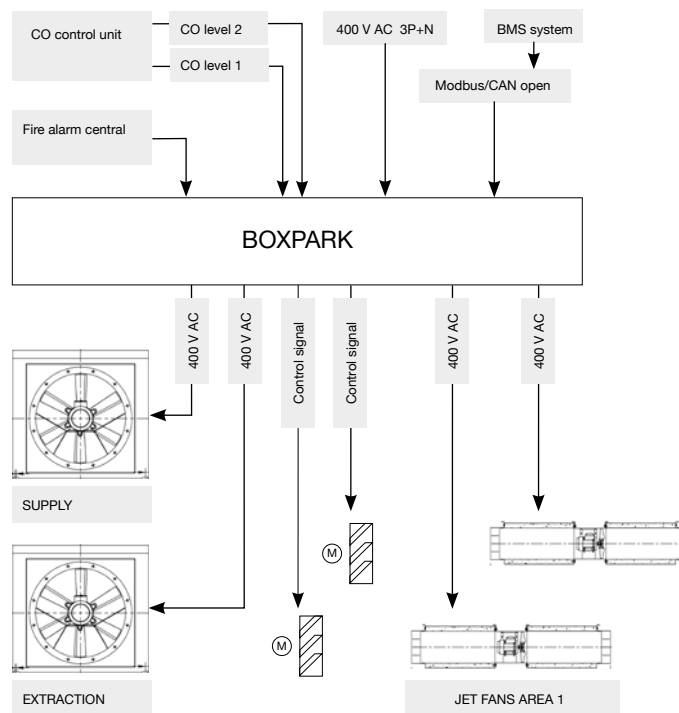

CJTHT/ATEX

400 °C/2h and 300 °C/2h axial exhaust units with ATEX certification



Extraction units with axial fans to work immersed in fire risk areas.

Fan:

- Fan with tubular sheet steel casing.
- Galvanised sheet steel structure with thermal insulation and acoustic insulation.
- Variable angle impeller made of cast aluminium.
- Approved in accordance with standard EN 12101-3, with certifications no.: 0370- CPR-0312 (F400) and 0370-CPR-0974 (F300).

Motor:

- Class H motors for S1 continuous operation and S2 emergency use. With ball bearings, IP55 protection and 1 or 2 speeds, depending on model.
- Motors with IE3 efficiency for powers equal to or greater than 0.75 kW, except single-phase, 2-speed and 8-pole.
- Three-phase 230/400 V 50 Hz (up to 3 kW) and 400/690 V 50 Hz (powers greater than 3 kW).

- Maximum temperature of air to be carried: S1 -20 °C +40 °C continuous service, also suitable for warm climates with temperatures up to 50 °C. S2 operation, 300 °C/2h, 400 °C/2h.

Finish:

- Fan: anti-corrosive in polyester resin polymerized at 190 °C, after degreasing with phosphate-free nanotechnological treatment.
- Box: anti-corrosive in galvanised sheet steel.

Available versions:

- CJTHT: axial fans with acoustically insulated boxes.
- CJTHT/ATEX: axial fans with acoustically insulated boxes and ATEX certification, category 3 Ex II3G for zone 2 (only 400 °C/2h and 300 °C/2h).
- CJTHT/PLUS Axial fans with acoustic attenuators.

On request:

- Airflow direction from impeller to motor.
- 100% reversible impellers.

Order code

From size 40 to size 100

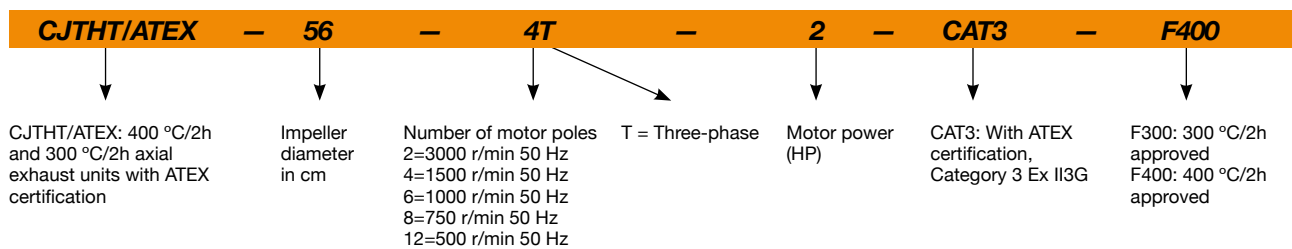

Size 125

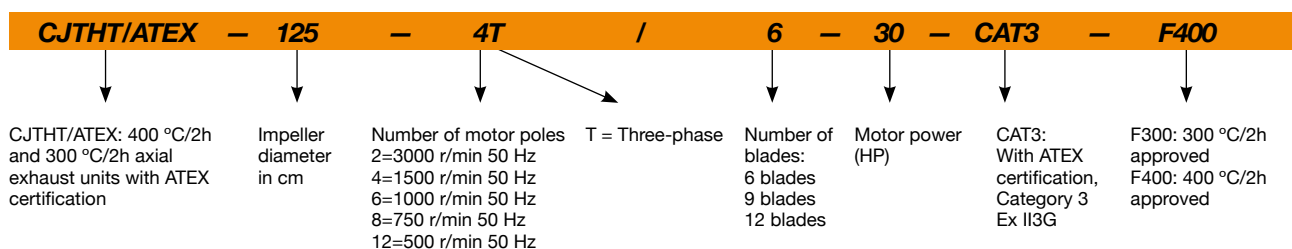

Technical characteristics

Model	Speed (r/min)	Maximum admissible current (A)			Installed power (kW)	Blade tilt angle (°)	Maximum flow rate (m³/h)	Sound pressure level¹ dB (A)	Approx. weight (Kg)
		230V	400V	690V					
CJTHT/ATEX-40-2/4T-1.5/CAT3	2920 / 1445		2.89 / 1.04		1.10 / 0.25	20	7040 / 3480	71 / 56	50
CJTHT/ATEX-40-4T-0.75/CAT3	1420	2.84	1.64		0.55	32	4820	55	41
CJTHT/ATEX-40-6T-0.75/CAT3	930	2.90	1.75		0.55	32	3150	46	49
CJTHT/ATEX-40-6/12T-0.75/CAT3	940 / 455		2.35 / 1.15		0.60 / 0.15	32	3150 / 1520	46 / 31	53
CJTHT/ATEX-45-2/4T-2/CAT3	2940 / 1465		3.58 / 1.19		1.50 / 0.37	16	9400 / 4680	71 / 56	53
CJTHT/ATEX-45-4T-0.75/CAT3	1420	2.84	1.64		0.55	36	7470	58	43
CJTHT/ATEX-45-6T-0.75/CAT3	930	2.90	1.75		0.55	30	4460	48	51
CJTHT/ATEX-45-6/12T-0.75/CAT3	940 / 455		2.35 / 1.15		0.60 / 0.15	30	4460 / 2150	48 / 33	55
CJTHT/ATEX-50-4T-0.75/CAT3	1420	2.84	1.64		0.55	22	8390	60	48
CJTHT/ATEX-50-6T-0.75/CAT3	930	2.90	1.75		0.55	32	7030	52	52
CJTHT/ATEX-56-4T-1/CAT3	1420	3.08	1.79		0.75	22	11280	63	59
CJTHT/ATEX-56-4T-1.5/CAT3	1420	4.10	2.37		1.10	30	13550	63	61
CJTHT/ATEX-56-4/8T-1.5/CAT3	1440 / 705		2.69 / 1.12		1.10 / 0.25	30	13550 / 6610	63 / 48	65
CJTHT/ATEX-56-4T-2/CAT3	1425	5.89	3.38		1.50	36	15030	64	63
CJTHT/ATEX-56-6T-0.75/CAT3	930	2.90	1.75		0.55	38	10140	54	61
CJTHT/ATEX-56-6/12T-0.75/CAT3	940 / 455		2.35 / 1.15		0.60 / 0.15	38	10140 / 4890	54 / 39	65
CJTHT/ATEX-63-4T-1/CAT3	1420	3.08	1.79		0.75	14	15190	67	63
CJTHT/ATEX-63-4T-1.5/CAT3	1420	4.10	2.37		1.10	20	17800	66	66
CJTHT/ATEX-63-4/8T-1.5/CAT3	1440 / 705		2.69 / 1.12		1.10 / 0.25	20	17800 / 8680	66 / 51	69
CJTHT/ATEX-63-4T-2/CAT3	1425	5.89	3.38		1.50	24	19280	66	67
CJTHT/ATEX-63-4/8T-2/CAT3	1415 / 715		3.40 / 1.65		1.50 / 0.30	24	19280 / 9740	66 / 52	74
CJTHT/ATEX-63-4T-3/CAT3	1435	7.86	4.52		2.20	32	22170	68	73
CJTHT/ATEX-63-4/8T-3/CAT3	1415 / 700		4.80 / 1.85		2.20 / 0.45	32	22170 / 10930	68 / 53	87
CJTHT/ATEX-63-4T-4/CAT3	1430	11.01	6.33		3.00	38	24240	69	78
CJTHT/ATEX-63-4/8T-4/CAT3	1425 / 710		6.45 / 2.28		3.00 / 0.60	38	24240 / 12070	69 / 54	91
CJTHT/ATEX-63-6T-0.75/CAT3	930	2.90	1.75		0.55	28	13590	57	66
CJTHT/ATEX-63-6/12T-0.75/CAT3	940 / 455		2.35 / 1.15		0.60 / 0.15	28	13590 / 6550	57 / 42	69
CJTHT/ATEX-63-6T-1/CAT3	940	3.36	1.93		0.75	38	15890	58	67
CJTHT/ATEX-63-6/12T-1/CAT3	935 / 455		3.75 / 2.76		0.80 / 0.20	38	15890 / 7700	58 / 43	71
CJTHT/ATEX-71-4T-1.5/CAT3	1420	4.10	2.37		1.10	12	19480	71	82
CJTHT/ATEX-71-4/8T-1.5/CAT3	1440 / 705		2.69 / 1.12		1.10 / 0.25	12	19480 / 9500	71 / 56	86
CJTHT/ATEX-71-4T-2/CAT3	1425	5.89	3.38		1.50	14	20920	70	84
CJTHT/ATEX-71-4/8T-2/CAT3	1415 / 715		3.40 / 1.65		1.50 / 0.30	14	20920 / 10570	70 / 56	91
CJTHT/ATEX-71-4T-3/CAT3	1435	7.86	4.52		2.20	22	25110	70	90
CJTHT/ATEX-71-4/8T-3/CAT3	1415 / 700		4.80 / 1.85		2.20 / 0.45	22	25110 / 12380	70 / 55	103
CJTHT/ATEX-71-4T-4/CAT3	1430	11.01	6.33		3.00	28	27480	70	95
CJTHT/ATEX-71-4/8T-4/CAT3	1425 / 710		6.45 / 2.28		3.00 / 0.60	28	27480 / 13680	70 / 55	108
CJTHT/ATEX-71-6T-0.75/CAT3	930	2.90	1.75		0.55	20	16100	60	82
CJTHT/ATEX-71-6/12T-0.75/CAT3	940 / 455		2.35 / 1.15		0.60 / 0.15	20	16100 / 7760	60 / 45	86
CJTHT/ATEX-71-6T-1/CAT3	940	3.36	1.93		0.75	26	17310	60	84
CJTHT/ATEX-71-6/12T-1/CAT3	935 / 455		3.75 / 2.76		0.80 / 0.20	26	17310 / 8390	60 / 45	87
CJTHT/ATEX-71-6T-1.5/CAT3	945	4.73	2.72		1.10	34	19930	61	86
CJTHT/ATEX-71-6/12T-1.5/CAT3	940 / 460		3.52 / 2.00		1.20 / 0.30	34	19930 / 9760	61 / 46	97
CJTHT/ATEX-80-4T-3/CAT3	1435	7.86	4.52		2.20	12	25460	75	98
CJTHT/ATEX-80-4/8T-3/CAT3	1415 / 700		4.80 / 1.85		2.20 / 0.45	12	25460 / 12550	75 / 60	111
CJTHT/ATEX-80-4T-4/CAT3	1430	11.01	6.33		3.00	16	30270	74	103
CJTHT/ATEX-80-4/8T-4/CAT3	1425 / 710		6.45 / 2.28		3.00 / 0.60	16	30270 / 15070	74 / 59	115
CJTHT/ATEX-80-4T-5.5/CAT3	1440		7.95	4.61	4.00	18	32770	73	113
CJTHT/ATEX-80-4/8T-5.5/CAT3	1455 / 720		7.88 / 2.87		3.80 / 1.00	18	32770 / 16160	73 / 58	147
CJTHT/ATEX-80-6T-1.5/CAT3	945	4.73	2.72		1.10	18	21470	63	95
CJTHT/ATEX-80-6/12T-1.5/CAT3	940 / 460		3.52 / 2.00		1.20 / 0.30	18	21470 / 10510	63 / 48	105
CJTHT/ATEX-80-6T-2/CAT3	945	6.25	3.62		1.50	26	25970	64	99
CJTHT/ATEX-80-6/12T-2/CAT3	960 / 470		4.46 / 3.43		1.60 / 0.40	26	25970 / 12710	64 / 49	113
CJTHT/ATEX-80-6T-3/CAT3	950	9.78	5.62		2.20	32	29930	65	113

Technical characteristics

Model	Speed (r/min)	Maximum admissible current (A)			Installed power (kW)	Blade tilt angle (°)	Maximum flow rate (m³/h)	Sound pressure level¹ dB (A)	Approx. weight (Kg)
		230V	400V	690V					
CJTHT/ATEX-80-6/12T-3/CAT3	940 / 475		5.62 / 3.32		2.20 / 0.55	32	29930 / 15120	65 / 51	118
CJTHT/ATEX-80-8T-0.75/CAT3	700	3.48	2.00		0.55	20	17540	57	99
CJTHT/ATEX-80-8T-1/CAT3	710	5.06	2.92		0.75	28	20680	58	111
CJTHT/ATEX-90-4T-4/CAT3	1430	11.01	6.33		3.00	8	33580	79	127
CJTHT/ATEX-90-4/8T-4/CAT3	1425 / 710		6.45 / 2.28		3.00 / 0.60	8	33580 / 16720	79 / 64	139
CJTHT/ATEX-90-4T-5.5/CAT3	1440		7.95	4.61	4.00	12	38890	78	137
CJTHT/ATEX-90-4/8T-5.5/CAT3	1455 / 720		7.88 / 2.87		3.80 / 1.00	12	38890 / 19170	78 / 63	171
CJTHT/ATEX-90-4T-7.5/CAT3	1460		10.40	6.04	5.50	18	46140	77	171
CJTHT/ATEX-90-4/8T-7.5/CAT3	1455 / 725		11.40 / 3.86		5.50 / 1.10	18	46140 / 22910	77 / 62	190
CJTHT/ATEX-90-4T-10/CAT3	1460		14.20	8.17	7.50	22	50140	76	208
CJTHT/ATEX-90-4/8T-10/CAT3	1455 / 725		15.10 / 5.16		7.50 / 1.50	22	50140 / 24900	76 / 61	198
CJTHT/ATEX-90-6T-2/CAT3	945	6.25	3.62		1.50	16	28780	66	123
CJTHT/ATEX-90-6/12T-2/CAT3	960 / 470		4.46 / 3.43		1.60 / 0.40	16	28780 / 14090	66 / 51	137
CJTHT/ATEX-90-6T-3/CAT3	950	9.78	5.62		2.20	24	34000	66	137
CJTHT/ATEX-90-6/12T-3/CAT3	940 / 475		5.62 / 3.32		2.20 / 0.55	24	34000 / 17180	66 / 52	142
CJTHT/ATEX-90-6T-4/CAT3	970	12.80	6.36		3.00	30	38910	69	171
CJTHT/ATEX-90-6/12T-4/CAT3	970 / 485		7.37 / 3.53		2.80 / 0.70	30	38910 / 19460	69 / 54	171
CJTHT/ATEX-90-8T-1/CAT3	710	5.06	2.92		0.75	18	22910	60	135
CJTHT/ATEX-90-8T-2/CAT3	700	7.32	4.21		1.50	30	29490	63	139
CJTHT/ATEX-90-8T-3/CAT3	710	9.30	5.35		2.20	32	30850	64	171
CJTHT/ATEX-100-4T-7.5/CAT3	1460		10.40	6.04	5.50	10	46870	82	179
CJTHT/ATEX-100-4/8T-7.5/CAT3	1455 / 725		11.40 / 3.86		5.50 / 1.10	10	46870 / 23270	82 / 67	198
CJTHT/ATEX-100-4T-10/CAT3	1460		14.20	8.17	7.50	16	57420	79	216
CJTHT/ATEX-100-4/8T-10/CAT3	1455 / 725		15.10 / 5.16		7.50 / 1.50	14	54710 / 27170	80 / 65	206
CJTHT/ATEX-100-4T-15/CAT3	1460		20.70	11.99	11.00	22	66300	79	251
CJTHT/ATEX-100-4/8T-15/CAT3	1470 / 730		20.70 / 7.19		11.00 / 3.00	22	66300 / 32880	79 / 64	251
CJTHT/ATEX-100-4T-20/CAT3	1460		27.80	16.03	15.00	28	76160	80	258
CJTHT/ATEX-100-4/8T-20/CAT3	1470 / 725		31.72 / 11.75		15.00 / 3.80	28	76160 / 37560	80 / 65	258
CJTHT/ATEX-100-4T/9-15/CAT3	1460		20.70	11.99	11.00	18	55345	80	260
CJTHT/ATEX-100-4T/9-20/CAT3	1460		27.80	16.03	15.00	22	63265	80	268
CJTHT/ATEX-100-4T/9-25/CAT3	1475		35.40	20.39	18.50	26	70625	80	308
CJTHT/ATEX-100-4T/9-30/CAT3	1475		42.20	24.44	22.00	30	74845	82	316
CJTHT/ATEX-100-6T-3/CAT3	950	9.78	5.62		2.20	16	37620	70	145
CJTHT/ATEX-100-6/12T-3/CAT3	940 / 475		5.62 / 3.32		2.20 / 0.55	16	37620 / 19000	70 / 56	150
CJTHT/ATEX-100-6T-4/CAT3	970	12.80	6.36		3.00	20	41180	69	179
CJTHT/ATEX-100-6/12T-4/CAT3	970 / 485		7.37 / 3.53		2.80 / 0.70	20	41180 / 20590	69 / 54	179
CJTHT/ATEX-100-6T-5.5/CAT3	970		8.37	4.82	4.00	26	47780	70	187
CJTHT/ATEX-100-6T/9-5.5/CAT3	970		11.00	6.35	4.00	20	39020	70	196
CJTHT/ATEX-100-6T/9-7.5/CAT3	970		12.30	7.07	5.50	26	46765	71	200
CJTHT/ATEX-100-6T/9-10/CAT3	970		15.20	8.83	7.50	34	52255	74	225
CJTHT/ATEX-125-4T/6-20/CAT3	1455		27.80	16.03	15.00	10	78610	87	466
CJTHT/ATEX-125-4/8T/6-20/CAT3	1455 / 720		31.72 / 11.75		15.00 / 3.80	10	78610 / 38770	87 / 72	485
CJTHT/ATEX-125-4T/6-25/CAT3	1470		35.40	20.39	18.50	14	92000	86	549
CJTHT/ATEX-125-4/8T/6-27/CAT3	1470 / 730		39.70 / 14.10		20.00 / 5.00	16	98100 / 48550	85 / 70	557
CJTHT/ATEX-125-4T/6-30/CAT3	1470		42.20	24.44	22.00	16	98830	85	554
CJTHT/ATEX-125-4/8T/6-37/CAT3	1480 / 740		54.55 / 18.50		28.00 / 6.50	20	110250 / 54940	85 / 70	633
CJTHT/ATEX-125-4T/6-40/CAT3	1475		55.19	31.87	30.00	22	117000	85	606
CJTHT/ATEX-125-4T/6-50/CAT3	1480		66.40	38.26	37.00	26	130450	85	734
CJTHT/ATEX-125-4T/6-60/CAT3	1475		80.90	46.90	45.00	28	135820	85	747
CJTHT/ATEX-125-4T/6-75/CAT3	1480		98.60	57.20	55.00	34	152100	88	828
CJTHT/ATEX-125-4T/9-25/CAT3	1470		35.40	20.39	18.50	10	79680	87	558
CJTHT/ATEX-125-4T/9-30/CAT3	1470		42.20	24.44	22.00	12	88290	86	563
CJTHT/ATEX-125-4/8T/9-27/CAT3	1470 / 730		39.70 / 14.10		20.00 / 5.00	12	88290 / 43690	86 / 71	566
CJTHT/ATEX-125-4/8T/9-37/CAT3	1480 / 740		54.55 / 18.50		28.00 / 6.50	16	104040 / 51840	85 / 70	642

Technical characteristics

Model	Speed (r/min)	Maximum admissible current (A)			Installed power (kW)	Blade tilt angle (°)	Maximum flow rate (m³/h)	Sound pressure level¹ dB (A) Inlet	Approx. weight (Kg)
		230V	400V	690V					
CJTHT/ATEX-125-4T/9-40/CAT3	1475		55.19	31.87	30.00	16	104040	85	615
CJTHT/ATEX-125-4T/9-50/CAT3	1480		66.40	38.26	37.00	20	118350	85	743
CJTHT/ATEX-125-4T/9-60/CAT3	1475		80.90	46.90	45.00	24	134970	85	756
CJTHT/ATEX-125-4T/9-75/CAT3	1480		98.60	57.20	55.00	28	146770	86	837
CJTHT/ATEX-125-4T/9-100/CAT3	1480		128.00	74.22	75.00	34	158560	88	998
CJTHT/ATEX-125-4T/12-50/CAT3	1480		66.80	38.70	37.00	18	101660	86	752
CJTHT/ATEX-125-4T/12-60/CAT3	1475		80.90	46.90	45.00	20	109180	86	765
CJTHT/ATEX-125-4T/12-75/CAT3	1480		98.60	57.20	55.00	26	131240	86	846
CJTHT/ATEX-125-4T/12-100/CAT3	1480		128.00	74.22	75.00	32	154100	88	1016
CJTHT/ATEX-125-6T/6-5.5/CAT3	940		8.37	4.82	4.00	10	51300	77	402
CJTHT/ATEX-125-6T/6-7.5/CAT3	960		12.30	7.07	5.50	14	60640	75	410
CJTHT/ATEX-125-6/12T/6-7.5/CAT3	980 / 485		14.50 / 5.17		5.50 / 1.00	14	60640 / 30010	75 / 60	454
CJTHT/ATEX-125-6T/6-10/CAT3	970		15.20	8.83	7.50	20	72250	74	458
CJTHT/ATEX-125-6/12T/6-10/CAT3	975 / 490		13.6 / 5.69		7.20 / 1.80	20	72250 / 36310	74 / 60	466
CJTHT/ATEX-125-6T/6-15/CAT3	970		22.50	13.07	11.00	26	85450	74	475
CJTHT/ATEX-125-6/12T/6-15/CAT3	975 / 485		23.1 / 8.41		11.00 / 3.00	26	85450 / 42510	74 / 59	566
CJTHT/ATEX-125-6T/6-20/CAT3	970		29.00	16.78	15.00	30	92860	76	542
CJTHT/ATEX-125-6/12T/6-24/CAT3	980 / 485		41.60 / 13.21		17.60 / 2.85	34	99650 / 49320	78 / 63	631
CJTHT/ATEX-125-6T/9-10/CAT3	970		15.20	8.83	7.50	14	63490	77	467
CJTHT/ATEX-125-6/12T/9-10/CAT3	975 / 490		13.6 / 5.69		7.20 / 1.80	14	63490 / 31910	77 / 63	475
CJTHT/ATEX-125-6T/9-15/CAT3	970		22.50	13.07	11.00	20	77550	75	484
CJTHT/ATEX-125-6/12T/9-15/CAT3	975 / 485		23.1 / 8.41		11.00 / 3.00	20	77550 / 38580	75 / 60	575
CJTHT/ATEX-125-6T/9-20/CAT3	970		29.00	16.78	15.00	26	92950	75	551
CJTHT/ATEX-125-6/12T/9-24/CAT3	980 / 485		41.60 / 13.21		17.60 / 2.85	30	98530 / 48760	76 / 61	640
CJTHT/ATEX-125-6T/9-25/CAT3	975		36.10	20.77	18.50	32	101450	77	627
CJTHT/ATEX-125-6T/9-30/CAT3	975		42.30	24.35	22.00	36	106525	80	638
CJTHT/ATEX-125-6T/12-10/CAT3	970		15.20	8.83	7.50	12	49630	79	476
CJTHT/ATEX-125-6T/12-15/CAT3	970		22.50	13.07	11.00	18	67315	77	493
CJTHT/ATEX-125-6T/12-20/CAT3	970		29.00	16.78	15.00	24	81840	76	560
CJTHT/ATEX-125-6T/12-25/CAT3	975		36.10	20.77	18.50	30	96765	77	636
CJTHT/ATEX-125-6T/12-30/CAT3	975		42.30	24.35	22.00	32	102040	78	647
CJTHT/ATEX-125-6T/12-40/CAT3	985		56.00	32.50	30.00	34	106355	79	762

1 The noise level values are pressures in dB(A) measured at a distance of 3 metres in a free field.

Acoustic characteristics

Sound power spectrum Lw(A) in dB(A) per Hz frequency band
Values measured at inlet with maximum flow rate

	63	125	250	500	1000	2000	4000	8000		63	125	250	500	1000	2000	4000	8000
40-2-1.5	47	63	75	83	88	86	82	75	56-12-0.75 (2V)	29	39	49	53	54	52	45	37
40-4-1.5 (2V)	32	48	60	68	73	71	67	60	63-4-1	48	64	76	82	84	81	74	66
40-4-0.75	37	53	63	70	71	68	67	68	63-4-1.5	47	63	75	81	83	80	73	65
40-6-0.75	28	44	54	61	62	59	58	59	63-8-1.5 (2V)	31	47	59	65	67	64	57	49
40-12-0.75 (2V)	12	28	38	45	46	43	42	43	63-4-2	54	66	75	81	81	81	75	67
45-2-2	47	60	74	86	87	86	82	74	63-8-2 (2V)	39	51	60	66	66	66	60	52
45-4-2 (2V)	32	45	59	71	72	71	67	59	63-4-3	56	68	77	83	83	83	77	69
45-4-0.75	47	59	67	73	73	73	68	60	63-8-3 (2V)	41	53	62	68	68	68	62	54
45-6-0.75	37	49	57	63	63	63	58	50	63-4-4	57	69	78	84	84	84	78	70
45-12-0.75 (2V)	21	33	41	47	47	47	42	34	63-8-4 (2V)	42	54	63	69	69	69	63	55
50-4-0.75	49	61	69	75	75	75	70	62	63-6-0.75	48	58	68	72	73	71	64	56
50-6-0.75	41	53	61	67	67	67	62	54	63-12-0.75 (2V)	32	42	52	56	57	55	48	40
56-4-1	51	63	72	78	78	78	72	64	63-6-1	49	59	69	73	74	72	65	57
56-4-1.5	51	63	72	78	78	78	72	64	63-12-1 (2V)	33	43	53	57	58	56	49	41
56-8-1.5 (2V)	35	47	56	62	62	62	56	48	71-4-1.5	57	73	80	86	86	86	82	74
56-4-2	52	64	73	79	79	79	73	65	71-8-1.5 (2V)	41	57	64	70	70	70	66	58
56-6-0.75	45	55	65	69	70	68	61	53	71-4-2	56	72	79	85	85	85	81	73

Acoustic characteristics

Sound power spectrum Lw(A) in dB(A) per Hz frequency band
Values measured at inlet with maximum flow rate

	63	125	250	500	1000	2000	4000	8000		63	125	250	500	1000	2000	4000	8000
71-8-2 (2V)	41	57	64	70	70	70	66	58	100-12-4 (2V)	41	56	66	69	70	67	59	51
71-4-3	56	72	79	85	85	85	81	73	100-6-5.5	57	72	82	85	86	83	75	67
71-8-3 (2V)	41	57	64	70	70	70	66	58	100-6/9-5.5	57	72	82	85	86	83	75	67
71-4-4	63	75	79	85	85	86	83	75	100-6/9-7.5	58	73	83	86	87	84	76	68
71-8-4 (2V)	48	60	64	70	70	71	68	60	100-6/9-10	61	76	86	89	90	87	79	71
71-6-0.75	46	53	73	76	76	71	63	55	125-4/6-20	69	85	96	103	104	102	95	87
71-12-0.75 (2V)	30	37	57	60	60	55	47	39	125-8/6-20 (2V)	54	70	81	88	89	87	80	72
71-6-1	46	64	73	76	76	71	64	55	125-4/6-25	68	84	95	102	103	101	94	86
71-12-1 (2V)	30	48	57	60	60	55	48	39	125-4/6-27	67	83	94	101	102	100	93	85
71-6-1.5	47	65	74	77	77	72	65	56	125-8/6-27 (2V)	52	68	79	86	87	85	78	70
71-12-1.5 (2V)	31	49	58	61	61	56	49	40	125-4/6-30	67	83	94	101	102	100	93	85
80-4-3	55	71	84	91	91	88	82	74	125-4/6-37	67	83	94	101	102	100	93	85
80-8-3 (2V)	40	56	69	76	76	73	67	59	125-8/6-37 (2V)	52	68	79	86	87	85	78	70
80-4-4	54	70	83	90	90	87	81	73	125-4/6-40	67	83	94	101	102	100	93	85
80-8-4 (2V)	39	55	68	75	75	72	66	58	125-4/6-50	67	83	94	101	102	100	93	85
80-4-5.5	53	69	82	89	89	86	80	72	125-4/6-60	67	83	94	101	102	100	93	85
80-8-5.5 (2V)	38	54	67	74	74	71	65	57	125-4/6-75	70	86	97	104	105	103	96	88
80-6-1.5	53	68	75	78	79	76	70	62	125-4/9-25	67	81	94	102	104	101	96	88
80-12-1.5 (2V)	37	52	59	62	63	60	54	46	125-4/9-27	66	80	93	101	103	100	95	87
80-6-2	59	69	75	79	80	78	73	65	125-8/9-27 (2V)	51	65	78	86	88	85	80	72
80-12-2 (2V)	43	53	59	63	64	62	57	49	125-4/9-30	66	80	93	101	103	100	95	87
80-6-3	60	70	76	80	81	79	74	66	125-4/9-37	65	79	92	100	102	99	94	86
80-12-3 (2V)	45	55	61	65	66	64	59	51	125-8/9-37 (2V)	50	64	77	85	87	84	79	71
80-8-0.75	46	59	67	72	74	71	64	53	125-4/9-40	65	79	92	100	102	99	94	86
80-8-1	47	60	68	73	75	72	65	54	125-4/9-50	65	79	92	100	102	99	94	86
90-4-4	61	77	88	94	95	93	88	80	125-4/9-60	73	86	95	99	101	100	96	89
90-8-4 (2V)	46	62	73	79	80	78	73	65	125-4/9-75	74	87	96	100	102	101	97	90
90-4-5.5	60	76	87	93	94	92	87	79	125-4/9-100	76	89	98	102	104	103	99	92
90-8-5.5 (2V)	45	61	72	78	79	77	72	64	125-4/12-50	66	80	93	101	103	100	95	87
90-4-7.5	59	75	86	92	93	91	86	78	125-4/12-60	66	80	93	101	103	100	95	87
90-8-7.5 (2V)	44	60	71	77	78	76	71	63	125-4/12-75	74	87	96	100	102	101	97	90
90-4-10	58	74	85	91	92	90	85	77	125-4/12-100	76	89	98	102	104	103	99	92
90-8-10 (2V)	43	59	70	76	77	75	70	62	125-6/6-5.5	64	79	89	92	93	90	85	77
90-6-2	52	67	78	82	82	78	71	63	125-6/6-7.5	62	77	87	90	91	88	83	75
90-12-2 (2V)	36	51	62	66	66	62	55	47	125-12/6-7.5 (2V)	47	62	72	75	76	73	68	60
90-6-3	52	67	78	82	82	78	71	63	125-6/6-10	61	76	86	89	90	87	82	74
90-12-3 (2V)	37	52	63	67	67	63	56	48	125-12/6-10 (2V)	46	61	71	74	75	72	67	59
90-6-4	60	70	80	85	85	82	76	68	125-6/6-15	61	76	86	89	90	87	82	74
90-12-4 (2V)	45	55	65	70	70	67	61	53	125-12/6-15 (2V)	46	61	71	74	75	72	67	59
90-8-1	42	63	70	75	78	74	67	56	125-6/6-20	63	78	88	91	92	89	84	76
90-8-2	51	66	73	78	81	77	70	59	125-6/6-24	65	80	90	93	94	91	86	78
90-8-3	53	67	74	79	82	78	71	60	125-12/6-24 (2V)	50	65	75	78	79	76	71	63
100-4-7.5	67	83	90	97	98	96	92	84	125-6/9-10	61	76	87	93	94	88	84	77
100-8-7.5 (2V)	52	68	75	82	83	81	77	69	125-12/9-10 (2V)	46	61	72	78	79	73	69	62
100-4-10	65	81	88	95	96	94	90	82	125-6/9-15	59	74	85	91	92	86	82	75
100-8-10 (2V)	50	66	73	80	81	79	75	67	125-12/9-15 (2V)	44	59	70	76	77	71	67	60
100-4-15	71	83	87	93	94	94	91	83	125-6/9-20	59	74	85	91	92	86	82	75
100-8-15 (2V)	56	68	72	78	79	79	76	68	125-6/9-24	60	75	86	92	93	87	83	76
100-4-20	72	84	88	94	95	95	92	84	125-12/9-24 (2V)	45	60	71	77	78	72	68	61
100-8-20 (2V)	57	69	73	79	80	80	77	69	125-6/9-25	61	76	87	93	94	88	84	77
100-4/9-15	65	81	88	95	96	94	90	82	125-6/9-30	64	79	90	96	97	91	87	80
100-4/9-20	72	84	88	94	95	95	92	84	125-6/12-10	63	78	89	95	96	90	86	79
100-4/9-25	72	84	88	94	95	95	92	84	125-6/12-15	61	76	87	93	94	88	84	77
100-4/9-30	74	86	90	96	97	97	94	86	125-6/12-20	60	75	86	92	93	87	83	76
100-6-3	57	72	82	85	86	83	75	67	125-6/12-25	61	76	87	93	94	88	84	77
100-12-3 (2V)	42	57	67	70	71	68	60	52	125-6/12-30	62	77	88	94	95	89	85	78
100-6-4	56	71	81	84	85	82	74	66	125-6/12-40	63	78	89	95	96	90	86	79

Dimensions mm

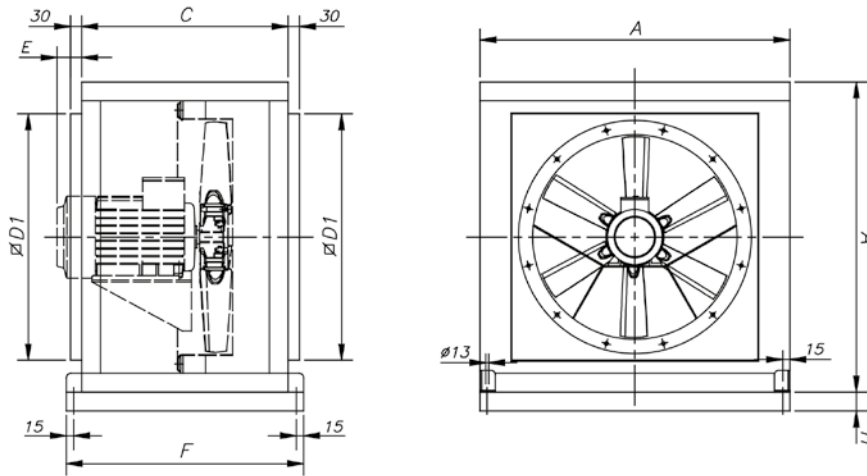

	A	C	ØD1	E	F	H
CJTHT/ATEX-40/45/50	700	550	565	-	630	-
CJTHT/ATEX-56/63	825	550	690	140	630	-
CJTHT/ATEX-71/80	1000	650	850	-	730	-
CJTHT/ATEX-90/100	1200	750	1050	-	830	-
CJTHT/ATEX-125 ≤20 HP	1600	1200	1400	-	1280	-
CJTHT/ATEX-125 >20 HP	1600	1200	1400	123	1280	100

Characteristic curves

See series characteristic curves: THT

Accessories



INT/ATEX



IAT



CABLE BOX



C2V



VSD3/A-RFT
- VSD1/A-RFM



CENTRAL CO



AET



P-400

THT/IMP

400 °C/2h and 300 °C/2h long range unidirectional or reversible jet fans



THT/IMP-C



THT/IMP-O

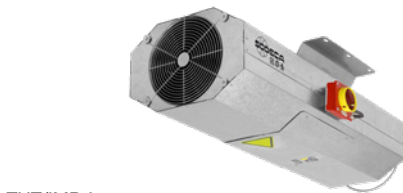

THT/IMP-L

300 °C/2h and 400 °C/2h long range unidirectional or reversible jet fans with a circular design (THT/IMP-C), octagonal design (THT/IMP-L) or octagonal painted design (THT/IMP-O).

Fan:

- Unidirectional or reversible fan assembly consisting of fan, silencers, deflectors and supports, approved for smoke evacuation, according to EN 12101-3, with certification N°: 0370-CPR-1363 (F400) and 0370-CPR-0822 (F300).
- Adjustable cast aluminum impeller designed to obtain high thrusts.
- Protection grid against contacts according to the UNE-EN ISO 12499 standard in unidirectional models.
- Deflector for increased air reach, on the outlet side. Reversible models are equipped with deflectors on both sides.
- High attenuation silencers with thermal and acoustic insulation.
- IAT series safety switch built into the fan (THT/IMP-L and THT/IMP-O) or on request (THT/IMP-C).
- Airflow direction from motor to impeller or 100% reversible.
- THT/IMP-C: Painted sheet steel circular casing.
- THT/IMP-L: Galvanized sheet steel casing.
- THT/IMP-O: Painted sheet metal casing.
- THT/IMP-LS: Casing of reduced length, in galvanized sheet steel.

Motor:

- Class H motors for continuous use S1 and emergency use S2. With ball bearings, IP55 protection and 2 speeds.
- Three-phase 400 V 50 Hz DAHLANDER.
- Maximum temperature of air to be carried: S1 -25 °C +40 °C continuous service, also suitable for warm climates with temperatures up to 50 °C. S2 operation, 300 °C/2h, 400 °C/2h.

Finish:

- Anti-corrosive in polyester resin polymerized at 190 °C, after degreasing with phosphate-free nanotechnological treatment (THT/IMP-C, THT/IMP-O) or anti-corrosive in galvanized steel sheet (THT/IMP-L).

On request:

- Thrust performance other than those indicated.

Order code

THT/IMP	-	O	-	UNI	-	38	-	2/4T	-	1.5	-	F400	
THT/IMP: 400 °C/2h and 300 °C/2h long range unidirectional or reversible jet fans		Design: C: Circular casing O: Painted casing L: Galvanized sheet casing LS: Casing of reduced length		Airflow direction UNI: Unidirectional REV: Reversible		Impeller diameter in cm		Number of motor poles 2=2900 r/min 50 Hz 4=1400 r/min 50 Hz		T = Three-phase		Motor power (HP)	F300: 300 °C/2h approved F400: 400 °C/2h approved

Technical characteristics

Unidirectional								
Model	Speed	Maximum admissible current (A) 400V	Maximum flow rate (m³/h)	Thrust (N)	Impulsion speed (m/s)	Installed power (kW)	Sound pressure level¹ dB (A)	Approx. weight (Kg)
	(r/min)							
THT/IMP-C-UNI-31-2/4T	2780 / 1380	1.50 / 0.60	4260 / 2115	21 / 10	15.6 / 7.7	0.55 / 0.15	51 / 35	65
THT/IMP-C-UNI-35-2/4T	2905 / 1445	2.40 / 0.77	6360 / 3165	36 / 18	17.8 / 8.9	0.85 / 0.20	52 / 36	70
THT/IMP-C-UNI-38-2/4T-1.5	2900 / 1435	2.89 / 1.04	8450 / 4180	57 / 28	20.7 / 10.2	1.10 / 0.25	47 / 31	89
THT/IMP-C-UNI-40-2/4T-1.5	2900 / 1435	2.89 / 1.04	9250 / 4585	60 / 30	20.4 / 10.1	1.10 / 0.25	53 / 37	98
THT/IMP-C-UNI-45-2/4T-2	2875 / 1430	3.58 / 1.19	10800 / 5375	62 / 31	18.1 / 9.0	1.50 / 0.37	57 / 41	132
THT/IMP-C-UNI-45-2/4T-3	2885 / 1435	4.79 / 1.54	13200 / 6570	92 / 46	22.1 / 11.0	2.20 / 0.60	58 / 42	133
THT/IMP-C-UNI-50-2/4T-6	2915 / 1445	9.50 / 2.80	19700 / 9770	165 / 82	26.4 / 13.1	4.50 / 1.30	60 / 44	220
THT/IMP-O-UNI-29-2/4T	2780 / 1380	1.50 / 0.60	4000 / 1990	21 / 10	16.8 / 8.3	0.55 / 0.15	37 / 21	69
THT/IMP-O-UNI-35-2/4T	2905 / 1445	2.40 / 0.77	6360 / 3165	36 / 18	17.8 / 8.9	0.85 / 0.20	52 / 36	70
THT/IMP-O-UNI-38-2/4T-1.5	2900 / 1435	2.89 / 1.04	8450 / 4185	57 / 28	20.7 / 10.2	1.10 / 0.25	47 / 31	94
THT/IMP-O-UNI-40-2/4T-1.5	2900 / 1435	2.89 / 1.04	9250 / 4580	60 / 30	20.4 / 10.1	1.10 / 0.25	53 / 37	104
THT/IMP-O-UNI-45-2/4T-2	2875 / 1430	3.58 / 1.19	10800 / 5375	62 / 31	18.1 / 9.0	1.50 / 0.37	57 / 41	140
THT/IMP-O-UNI-45-2/4T-3	2885 / 1435	4.79 / 1.54	13200 / 6570	92 / 46	22.1 / 11.0	2.20 / 0.60	58 / 42	141
THT/IMP-O-UNI-50-2/4T-6	2915 / 1445	9.50 / 2.80	19700 / 9770	165 / 82	26.4 / 13.1	4.50 / 1.30	60 / 44	234
THT/IMP-L-UNI-29-2/4T	2780 / 1380	1.50 / 0.60	4000 / 1990	21 / 10	16.8 / 8.3	0.55 / 0.15	37 / 21	69
THT/IMP-L-UNI-35-2/4T	2905 / 1445	2.40 / 0.77	6360 / 3165	36 / 18	17.8 / 8.9	0.85 / 0.20	52 / 36	70
THT/IMP-L-UNI-38-2/4T-1.5	2900 / 1435	2.89 / 1.04	8450 / 4185	57 / 28	20.7 / 10.2	1.10 / 0.25	47 / 31	94
THT/IMP-L-UNI-40-2/4T-1.5	2900 / 1435	2.89 / 1.04	9250 / 4580	60 / 30	20.4 / 10.1	1.10 / 0.25	53 / 37	104
THT/IMP-L-UNI-45-2/4T-2	2875 / 1430	3.58 / 1.19	10800 / 5375	62 / 31	18.1 / 9.0	1.50 / 0.37	57 / 41	140
THT/IMP-L-UNI-45-2/4T-3	2885 / 1435	4.79 / 1.54	13200 / 6570	92 / 46	22.1 / 11.0	2.20 / 0.60	58 / 42	141
THT/IMP-L-UNI-50-2/4T-6	2915 / 1445	9.50 / 2.80	19700 / 9770	165 / 82	26.4 / 13.1	4.50 / 1.30	60 / 44	234
THT/IMP-LS-UNI-29-2/4T	2780 / 1380	1.50 / 0.60	4000 / 1990	21 / 10	16.8 / 8.3	0.55 / 0.15	39 / 23	55
THT/IMP-LS-UNI-35-2/4T	2905 / 1445	2.40 / 0.77	6360 / 3165	36 / 18	17.8 / 8.9	0.85 / 0.20	54 / 38	56
THT/IMP-LS-UNI-38-2/4T-1.5	2900 / 1435	2.89 / 1.04	8450 / 4185	57 / 28	20.7 / 10.2	1.10 / 0.25	49 / 33	76
THT/IMP-LS-UNI-40-2/4T-1.5	2900 / 1435	2.89 / 1.04	9250 / 4580	60 / 30	20.4 / 10.1	1.10 / 0.25	55 / 39	83
THT/IMP-LS-UNI-45-2/4T-2	2875 / 1430	3.58 / 1.19	10800 / 5375	62 / 31	18.1 / 9.0	1.50 / 0.37	59 / 43	112
THT/IMP-LS-UNI-45-2/4T-3	2885 / 1435	4.79 / 1.54	13200 / 6570	92 / 46	22.1 / 11.0	2.20 / 0.60	60 / 44	113
THT/IMP-LS-UNI-50-2/4T-6	2915 / 1445	9.50 / 2.80	19700 / 9770	165 / 82	26.4 / 13.1	4.50 / 1.30	62 / 46	187

¹ Sound pressure level in dB(A) at a distance of 10 m and at maximum flow rate.

Reversible								
Model	Speed	Maximum admissible current (A) 400V	Maximum flow rate (m³/h)	Thrust (N)	Impulsion speed (m/s)	Installed power (kW)	Sound pressure level¹ dB (A)	Approx. weight (Kg)
	(r/min)							
THT/IMP-C-REV-31-2/4T	2780 / 1380	1.50 / 0.60	3840 / 1910	17 / 8	14.1 / 7.0	0.55 / 0.15	50 / 34	63
THT/IMP-C-REV-35-2/4T	2905 / 1445	2.40 / 0.77	5940 / 2955	31 / 15	16.7 / 8.3	0.85 / 0.20	51 / 35	70
THT/IMP-C-REV-38-2/4T-2	2875 / 1430	3.58 / 1.19	8200 / 4080	54 / 27	20.1 / 10.0	1.50 / 0.37	49 / 33	91
THT/IMP-C-REV-40-2/4T-2	2875 / 1430	3.58 / 1.19	9250 / 4605	60 / 30	20.4 / 10.1	1.50 / 0.37	52 / 36	100
THT/IMP-C-REV-45-2/4T-2	2875 / 1430	3.58 / 1.19	10300 / 5125	56 / 28	17.2 / 8.6	1.50 / 0.37	56 / 40	131
THT/IMP-C-REV-45-2/4T-3	2885 / 1435	4.79 / 1.54	12800 / 6370	87 / 43	21.4 / 10.6	2.20 / 0.60	57 / 41	133
THT/IMP-C-REV-50-2/4T-6	2915 / 1445	9.50 / 2.80	19000 / 9420	153 / 76	25.4 / 12.6	4.50 / 1.30	60 / 44	267
THT/IMP-O-REV-29-2/4T	2780 / 1380	1.50 / 0.60	3400 / 1690	15 / 7	14.3 / 7.1	0.55 / 0.15	38 / 22	67
THT/IMP-O-REV-35-2/4T	2905 / 1445	2.40 / 0.77	5940 / 2955	31 / 15	16.7 / 8.3	0.85 / 0.20	51 / 35	70
THT/IMP-O-REV-38-2/4T-2	2875 / 1430	3.58 / 1.19	8200 / 4080	54 / 27	20.1 / 10	1.50 / 0.37	49 / 33	97
THT/IMP-O-REV-40-2/4T-2	2875 / 1430	3.58 / 1.19	9250 / 4605	60 / 30	20.4 / 10.1	1.50 / 0.37	52 / 36	106
THT/IMP-O-REV-45-2/4T-2	2875 / 1430	3.58 / 1.19	10300 / 5125	56 / 28	17.2 / 8.6	1.50 / 0.37	56 / 40	139
THT/IMP-O-REV-45-2/4T-3	2885 / 1435	4.79 / 1.54	12800 / 6370	87 / 43	21.4 / 10.6	2.20 / 0.60	57 / 41	141
THT/IMP-O-REV-50-2/4T-6	2915 / 1445	9.50 / 2.80	19000 / 9420	153 / 76	25.4 / 12.6	4.50 / 1.30	60 / 44	284
THT/IMP-L-REV-29-2/4T	2780 / 1380	1.50 / 0.60	3400 / 1690	15 / 7	14.3 / 7.1	0.55 / 0.15	38 / 22	67
THT/IMP-L-REV-35-2/4T	2905 / 1445	2.40 / 0.77	5940 / 2955	31 / 15	16.7 / 8.3	0.85 / 0.20	51 / 35	70
THT/IMP-L-REV-38-2/4T-2	2875 / 1430	3.58 / 1.19	8200 / 4080	54 / 27	20.1 / 10.0	1.50 / 0.37	49 / 33	97
THT/IMP-L-REV-40-2/4T-2	2875 / 1430	3.58 / 1.19	9250 / 4605	60 / 30	20.4 / 10.1	1.50 / 0.37	52 / 36	106

Dimensions mm

C: Circular casing

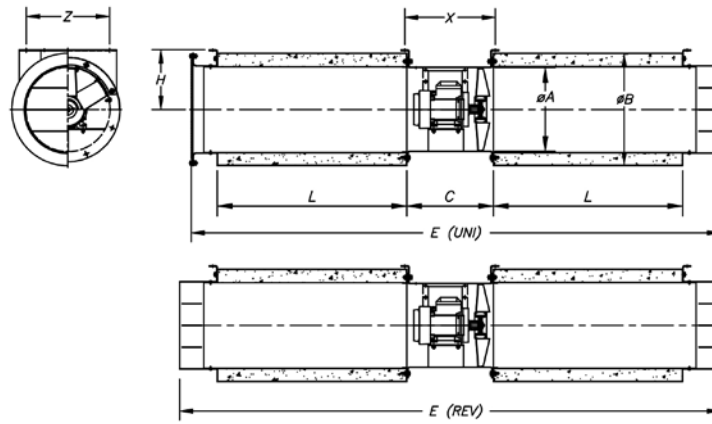

	$\varnothing A$	$\varnothing B$	C	L	$\varnothing d$	E (UNI)	E (REV)	H	X	Z
THT/IMP-C-31	315	415	320	700	10	1956	2000	220	345	275
THT/IMP-C-35	355	460	325	700	12	1960	2005	250	346	300
THT/IMP-C-38	380	460	340	1000	12	2570	2620	250	530	517
THT/IMP-C-40	410	510	340	950	12	2485	2540	280	376	340
THT/IMP-C-45	460	630	360	950	12	2500	2554	355	396	440

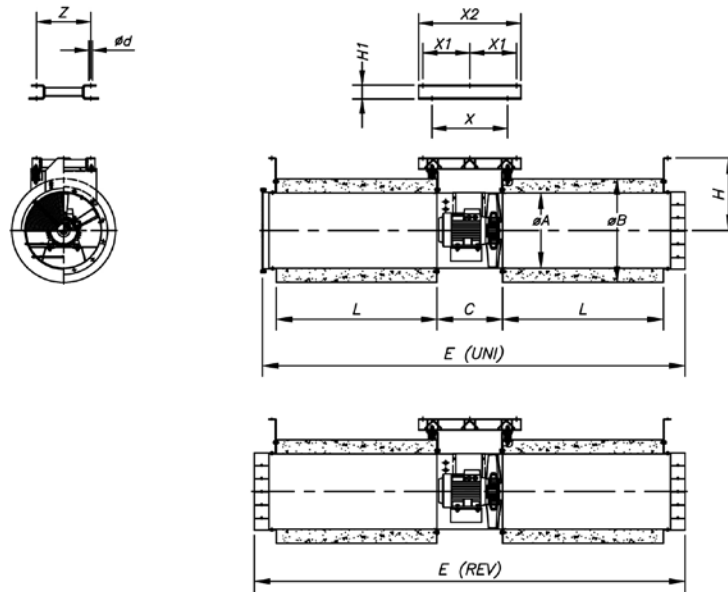

	$\varnothing A$	$\varnothing B$	C	L	$\varnothing d$	E (UNI)	E (REV)	H	H1	X	X1	X2	Z
THT/IMP-C-50	514	710	450	1100	12	2895	2950	498	80	518	320	700	370

Dimensions mm

O: Painted casing
L: Galvanised sheet casing
LS: Casing of reduced length

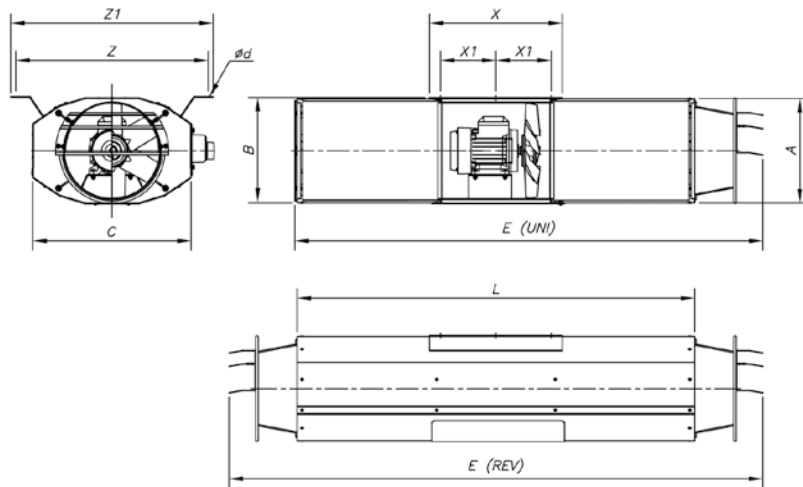

	A	B	C	ød	E (UNI)	E (REV)	L	X	X1	Z	Z1
THT/IMP-LS-29	319.5	324	479	12x26	1410	1610	1200	400	167	580	610
THT/IMP-L-29	319.5	324	479	12x26	2210	2410	2000	400	167	580	610
THT/IMP-O-29	319.5	324	479	12x26	2210	2410	2000	400	167	580	610
THT/IMP-LS-35	383	386	523	12x26	1410	1610	1200	400	167	614	644
THT/IMP-L-35	383	386	523	12x26	2210	2410	2000	400	167	614	644
THT/IMP-O-35	383	386	523	12x26	2210	2410	2000	400	167	614	644
THT/IMP-LS-38	406	409	550	12x26	1410	1610	1200	400	170	640	670
THT/IMP-L-38	406	409	550	12x26	2210	2410	2000	400	170	640	670
THT/IMP-O-38	406	409	550	12x26	2210	2410	2000	400	170	640	670
THT/IMP-LS-40	436	439	582	12x26	1410	1610	1200	400	170	670	700
THT/IMP-L-40	436	439	582	12x26	2210	2410	2000	400	170	670	700
THT/IMP-O-40	436	439	582	12x26	2210	2410	2000	400	170	670	700
THT/IMP-LS-45	486	489	630	12x26	1410	1610	1200	400	170	724	754
THT/IMP-L-45	486	489	630	12x26	2210	2410	2000	400	170	724	754
THT/IMP-O-45	486	489	630	12x26	2210	2410	2000	400	170	724	754
THT/IMP-LS-50	546	549	742	12x26	1445	1675	1200	560	255	778	808
THT/IMP-L-50	546	549	742	12x26	2245	2475	2000	560	255	778	808
THT/IMP-O-50	546	549	742	12x26	2245	2475	2000	560	255	778	808

Application in garages

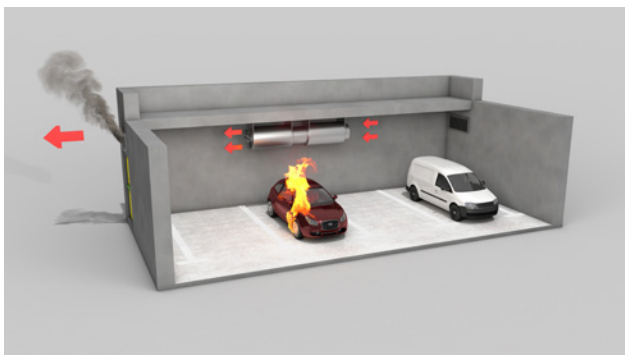

Installation of Jet Fan inside fire danger zone

Accessories



Configuration with BOXPARK



Control panels for car park ventilation systems with triple purpose: daily ventilation, CO concentration control and smoke extraction in case of fire

Control panels in metal enclosure with all the necessary elements for the management and control of fans in car park ventilation systems, whether they are based on duct networks or impulse fans, for the control of CO concentration levels and smoke extraction in case of fire. Customised panels for all power ratings and number of fans according to project requirements.

More information see BOXPARK series.

Installation examples with BOXPARK

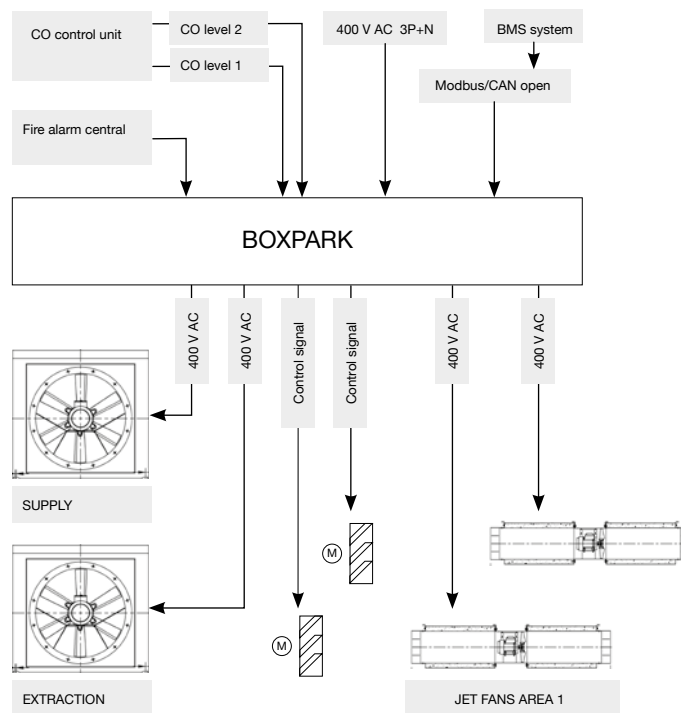

TUNEL JET FAN

Jet fans specially designed for tunnel ventilation. 400 °C/2h and 300 °C/2h certificates, depending on model



Unidirectional jet fan, very robust with cast aluminum impeller for medium thrust. Specially designed for tunnel ventilation and smoke evacuation in case of fire, certified 400 °C/2h and 300 °C/2h according to model.

Fan:

- Large thickness tubular sheet steel casing.
- Motor support welded to the casing.
- Aerodynamic inlet and discharge cone.
- Optimal surface protection by high quality steel.
- One way rotor made of cast aluminium.
- Tubular silencer coupled to both ends that provides high thermal and acoustic insulation.
- Support base specially designed to support the entire set. From the 560 mm diameter it incorporates anti-vibration springs.
- Electrical connection in external terminal box.
- E90 cable with metal protection.
- Support feet or support bench depending on the model included in the set.
- Vibration isolators.
- Security anchor included.
- Approved in accordance with standard EN 12101-3.

Motor:

- Class H motors for S1 continuous operation and S2 emergency use. With ball bearings and IP55 protection.
- Motors with IE3 efficiency for powers equal to or greater than 0.75 kW, except single-phase, 2-speed and 8-pole.
- Three-phase 400/690 V 50 Hz.
- Maximum temperature of air to be carried: S1 -25 °C +40 °C continuous service, also suitable for warm climates with temperatures up to 50 °C. S2 operation, 300 °C/2h, 400 °C/2h.

Finish:

- High protection anti-corrosive steel, special primer and high quality paint for corrosive atmospheres.

On request:

- IP55 standard motors, ATEX and 2 speed motors.
- Total stainless steel construction.
- Hot dip galvanized steel construction.

Order code

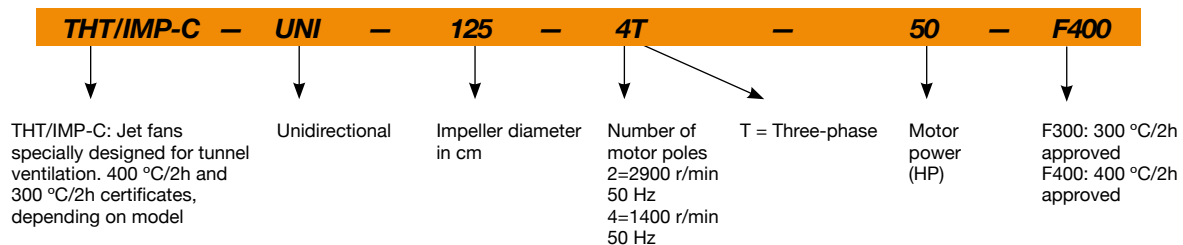

Technical characteristics

Model	Speed (r/min)	Maximum admissible current (A)			Maximum flow rate (m ³ /h)	Thrust (N)	Impulsion speed (m/s)	Installed power (kW)	Sound pressure level ¹ dB (A)	Approx. weight (Kg)
		230V	400V	690V						
THT/IMP-C-UNI-56-2T-12 IE3	2975		18.07	10.44	29500	312	37.6	9.2	64	273
THT/IMP-C-UNI-56-4T-2 IE3	1435	5.89	3.38		14550	76	16.4	1.5	50	197
THT/IMP-C-UNI-63-2T-20 IE3	2935		26.50	15.35	40050	455	37.1	15.0	68	323
THT/IMP-C-UNI-63-4T-3 IE3	1450	7.86	4.52		21550	132	19.2	2.2	53	241
THT/IMP-C-UNI-71-4T-4 IE3	1455	11.01	6.33		28550	182	20.0	3.0	65	279
THT/IMP-C-UNI-80-4T-5.5 IE3	1445		7.95	4.61	36900	239	20.4	4.0	63	414
THT/IMP-C-UNI-90-4T-10 IE3	1460		14.20	8.17	52000	375	22.7	7.5	65	495
THT/IMP-C-UNI-100-4T-15 IE3	1460		20.70	11.99	66500	497	23.5	11.0	63	667
THT/IMP-C-UNI-125-4T-30 IE3	1475		42.20	24.44	98100	692	22.2	22.0	59	980
THT/IMP-C-UNI-125-4T-50 IE3	1480		66.80	38.70	123700	1101	28.0	37.0	62	1110

¹ Sound pressure level in dB(A) at a distance of 10 m and at maximum flow rate.

Acoustic characteristics

Sound power spectrum L_w(A) in dB(A) per Hz frequency band

	63	125	250	500	1000	2000	4000	8000		63	125	250	500	1000	2000	4000	8000
56-2T-12	66	72	90	79	82	81	79	70	80-4T-5.5	65	71	89	78	81	80	78	69
56-4T-2	52	58	76	65	68	67	65	56	90-4T-10	67	73	91	80	83	82	80	71
63-2T-20	70	76	94	83	86	85	83	74	100-4T-15	65	71	89	78	81	80	78	69
63-4T-3	55	61	79	68	71	70	68	59	125-4T-30	61	67	85	74	77	76	74	65
71-4T-4	67	73	91	80	83	82	80	71	125-4T-50	64	70	88	77	80	79	77	68

Dimensions mm

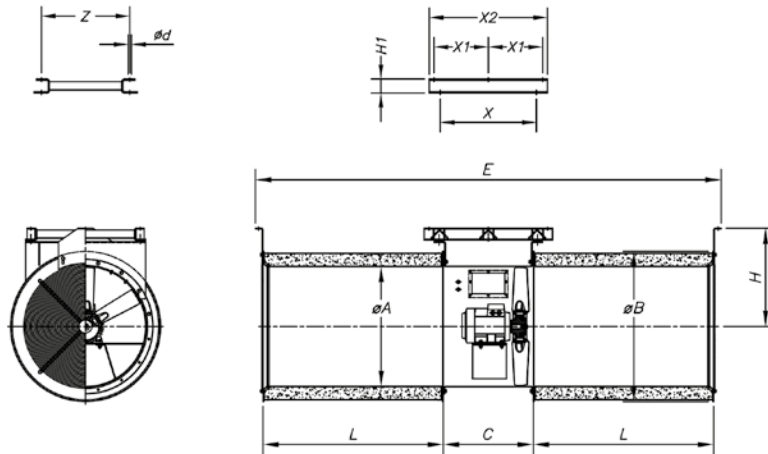

	ØA	ØB	C	L	Ød	E	H	H1	X	X1	X2	Z
THT/IMP-C-UNI-56	560	750	500	1200	12	3093	503	80	558	345	750	465
THT/IMP-C-UNI-63	640	800	650	1200	14	3242	525	80	706	418	900	545
THT/IMP-C-UNI-71	710	900	500	1200	14	3092	600	80	558	345	750	465
THT/IMP-C-UNI-80	800	1000	600	1200	14	3104	655	80	656	395	855	730
THT/IMP-C-UNI-90	900	1100	600	1200	14	3105	675	80	677	405.5	876	825
THT/IMP-C-UNI-100	1000	1200	700	1200	14	3205	730	80	767	450	965	884
THT/IMP-C-UNI-125	1250	1503	650	1350	17	3455	953	100	717	575	1250	1150

Characteristic curves

Q= Flow rate in m³/h, m³/s and cfm Pe= Static pressure in mm H₂O, Pa and inwg

Pressure (shaded area) Thrust (N) (dashed line)

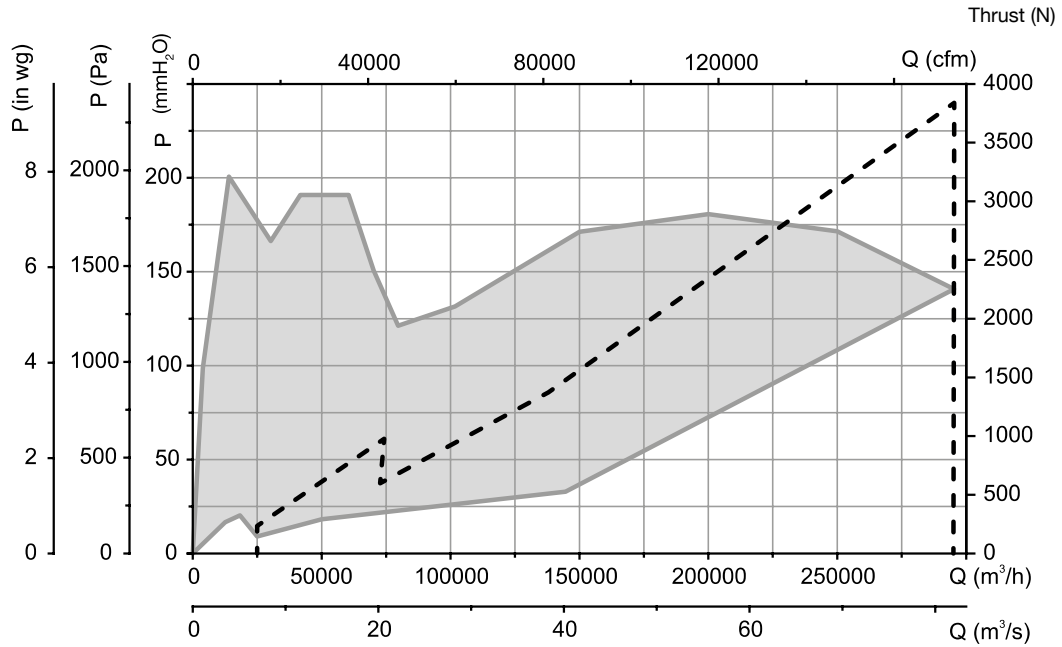

Application example



LONGITUDINAL VENTILATION

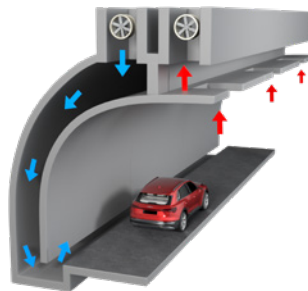

TRANSVERSE VENTILATION



SEMI-TRANSVERSE VENTILATION

Accessories



CI



Long-range 300 °C/2h and 400 °C/2h centrifugal induction jet fans for use in fire risk zones with a low profile



Long range 300 °C/2h and 400 °C/2h centrifugal induction jet fans for use in fire risk zones with a low profile.

Fan:

- Sheet steel casing.
- Backward curved impeller in highly robust sheet steel.
- IAT series safety switch built into the fan.
- Fixing feet included.

Motor:

- Class H motors for S1 continuous operation and S2 emergency use. With ball bearings, IP55 protection and 1 or 2 speeds, depending on model.

- Three-phase 230/400 V 50 Hz.

- Maximum temperature of air to be carried: S1 -20 °C +40 °C continuous service, also suitable for warm climates with temperatures up to 50 °C. S2 operation, 300 °C/2h, 400 °C/2h.

Finish:

- Anti-corrosive finish in polyester resin, polymerised at 190 °C, after degreasing with phosphate-free nanotechnology treatment.

Order code

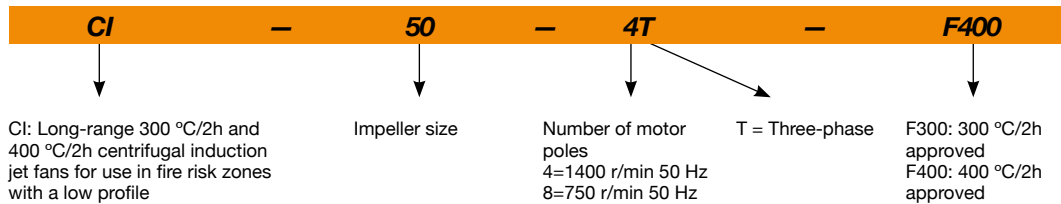

Technical characteristics

Model	Speed (r/min)	Maximum admissible current (A)		Maximum flow rate (m³/h)	Thrust (N)	Impulsion speed (m/s)	Installed power (kW)	Sound pressure level ¹ dB (A)	Approx. weight (Kg)
		230V	400V						
CI-50-4T	1395	5.00	2.90	6050	50	23.5	1.20	64	83
CI-50-4/8T	1395 / 650		2.90 / 1.20	6050 / 2820	50 / 23	23.5 / 10.9	1.20 / 0.30	64 / 47	83
CI-75-4/8T	1450 / 730		5.20 / 2.05	8080 / 4070	75 / 38	26.3 / 13.2	2.20 / 0.37	65 / 50	139
CI-100-4T	1445	9.90	5.70	9340	100	30.0	2.40	67	141
CI-100-4/8T	1445 / 715		5.70 / 2.20	9340 / 4625	100 / 49	30.0 / 14.8	2.40 / 0.55	67 / 51	141

¹ Sound pressure level in dB(A) at a distance of 10 m and at maximum flow rate.

Acoustic characteristics

Sound power spectrum Lw(A) in dB(A) per Hz frequency band

	63	125	250	500	1000	2000	4000	8000		63	125	250	500	1000	2000	4000	8000	
CI-50-4T	63	75	82	86	88	85	81	75		CI-75-4/8T (2V)	50	67	69	73	74	68	64	60
CI-50-4/8T	63	75	82	86	88	85	81	75		CI-100-4T	68	85	87	89	90	85	80	73
CI-50-4/8T (2V)	46	58	65	69	71	68	64	58		CI-100-4/8T	68	85	87	89	90	85	80	73
CI-75-4/8T	65	82	84	88	89	83	79	75		CI-100-4/8T (2V)	52	69	71	73	74	69	64	57

Dimensions mm

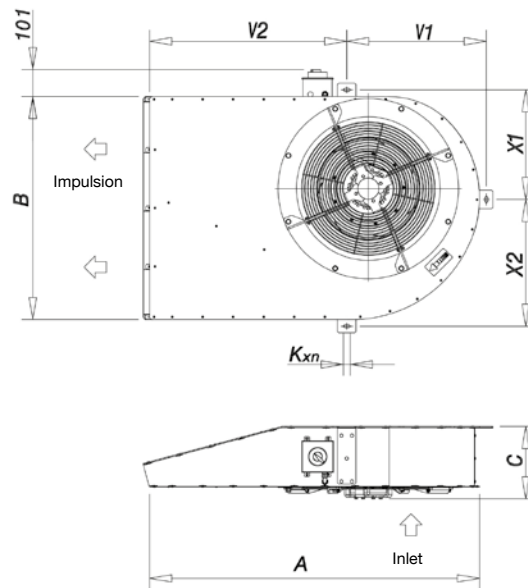

	A	B	C	V2	V1	X1	X2	Kxn
CI-50-F300	1240	840	272.5	741.5	524.5	413	477	12x26
CI-50-F400	1240	840	261.5	741.5	524.5	413	477	12x26
CI-75-F300	1778	1040	311	1143	662	494	596	12x26
CI-75-F400	1778	1040	299	1143	662	494	596	12x26
CI-100 F-300	1778	1040	323	1143	662	494	596	12x26
CI-100 F-400	1778	1040	323	1143	662	494	596	12x26

Accessories



INT



IAT



CABLE BOX



C2V



AET



CENTRAL CO



VSD3/A-RFT
- VSD1/A-RFM



P-400



BOXPARK

Configuration with BOXPARK



Control panels for car park ventilation systems with triple purpose: daily ventilation, CO concentration control and smoke extraction in case of fire

Control panels in metal enclosure with all the necessary elements for the management and control of fans in car park ventilation systems, whether they are based on duct networks or impulse fans, for the control of CO concentration levels and smoke extraction in case of fire. Customised panels for all power ratings and number of fans according to project requirements.

More information see BOXPARK series.

Installation examples with BOXPARK

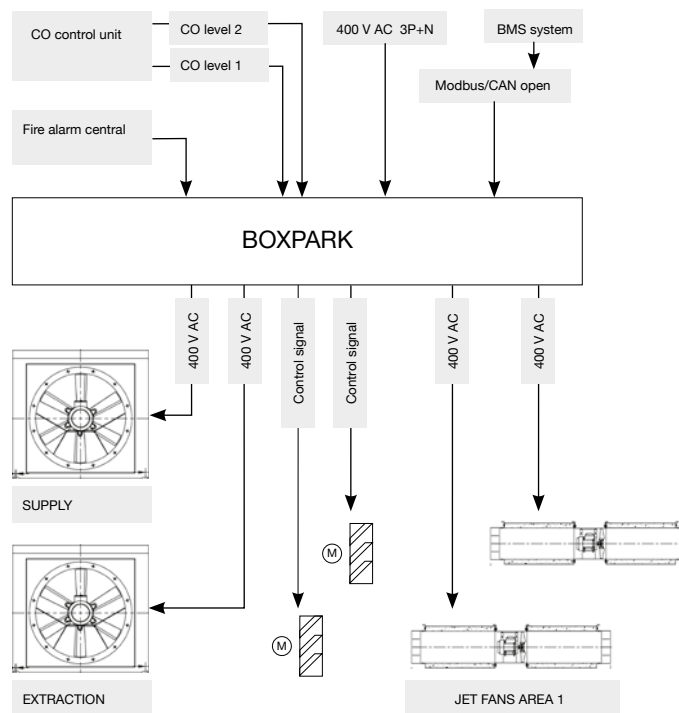

HTMF

400 °C/2h (F400) and 300 °C/2h (F300) roof mounted multifunctional extract fans



400 °C/2h and 300 °C/2h rated roof mounted multifunctional extract fans for work in fire risk zones, designed for smoke extraction in industrial or similar buildings.

Fan:

- Support base in painted galvanized steel sheet.
- Adjustable cast aluminum impeller.
- Protection grid against contacts according to UNE-EN ISO 12499.
- Cap in painted galvanized steel sheet, with natural air outlet. Approval according to EN 12101-3, with certifications No. 0370-CPR 0544 (F400) and 0370-CPR-3073 (F300).

Motor:

- Class H motors for S1 continuous operation and S2 emergency use. With ball bearings, IP55 protection and 1 or 2 speeds, depending on model.

- Motors with IE3 efficiency for powers equal to or greater than 0.75 kW, except single-phase, 2-speed and 8-pole.
- Three-phase 230/400 V 50 Hz (up to 3 kW) and 400/690 V 50 Hz (powers greater than 3 kW).
- Maximum temperature of air to be carried: S1 -20 °C +40 °C continuous service, also suitable for warm climates with temperatures up to 50 °C. S2 operation, 300 °C/2h, 400 °C/2h.

Finish:

- Anti-corrosive finish in polyester resin, polymerised at 190 °C, after degreasing with phosphate-free nanotechnology treatment.

Order code

From size 56 to size 100

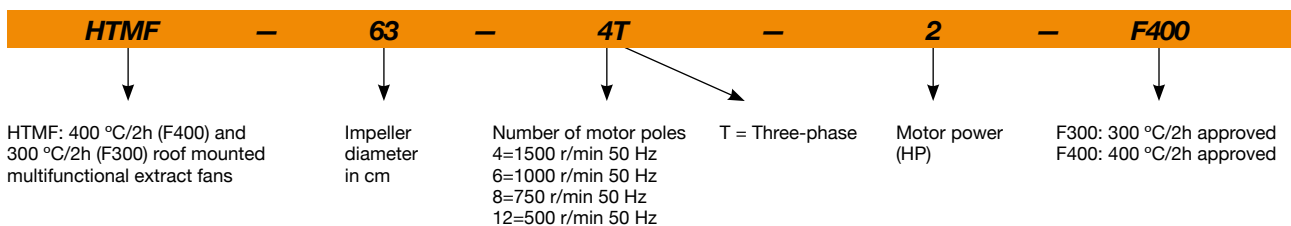

Size 125

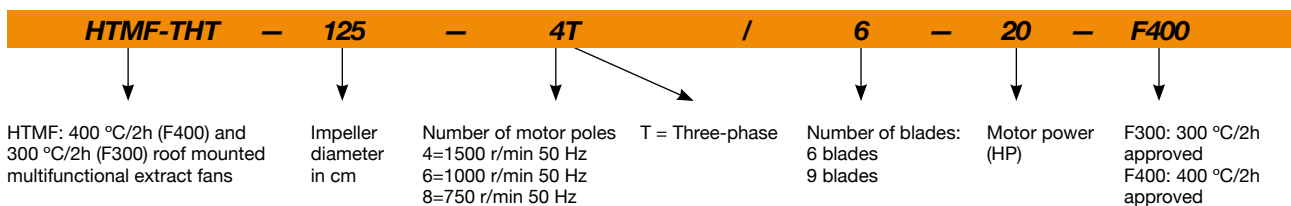

Technical characteristics

Model	Speed (r/min)	Maximum admissible current (A)			Installed power (kW)	Maximum flow rate (m ³ /h)	Sound pressure level ¹ dB (A)		Approx. weight (Kg)
		230V	400V	690V			Inlet	Exhaust	
HTMF-56-4T-1 IE3	1410	3.08	1.79		0.75	10640	54	51	79
HTMF-56-4T-1.5 IE3	1430	4.10	2.37		1.10	11530	55	52	79
HTMF-56-4/8T-1.5	1420 / 695		2.69 / 1.12		1.10 / 0.25	11530 / 5620	55 / 39	52 / 36	79
HTMF-56-6T-0.75	930	2.90	1.75		0.55	8255	43	41	80
HTMF-63-4T-1.5 IE3	1430	4.10	2.37		1.10	13930	57	54	94
HTMF-63-4/8T-1.5	1420 / 695		2.69 / 1.12		1.10 / 0.25	13930 / 6800	57 / 41	54 / 38	94
HTMF-63-4T-2 IE3	1435	5.89	3.38		1.50	15630	58	55	96
HTMF-63-4/8T-2	1430 / 725		3.40 / 1.65		1.50 / 0.30	15630 / 7900	58 / 43	55 / 40	106
HTMF-63-4T-3 IE3	1450	7.86	4.52		2.20	18045	59	56	108
HTMF-63-4/8T-3	1430 / 705		4.80 / 1.85		2.20 / 0.45	18045 / 8900	59 / 44	56 / 41	112
HTMF-63-6T-0.75	930	2.90	1.75		0.55	10449	48	46	95
HTMF-63-6T-1 IE3	935	3.36	1.93		0.75	11355	49	47	95
HTMF-71-4T-2 IE3	1435	5.89	3.38		1.50	16370	61	58	109
HTMF-71-4/8T-2	1430 / 725		3.40 / 1.65		1.50 / 0.30	16370 / 8270	61 / 46	58 / 43	119
HTMF-71-4T-3 IE3	1450	7.86	4.52		2.20	18490	63	60	122
HTMF-71-4/8T-3	1430 / 705		4.80 / 1.85		2.20 / 0.45	18490 / 9120	63 / 48	60 / 45	125
HTMF-71-4T-4 IE3	1455	11.01	6.33		3.00	22685	64	61	133
HTMF-71-4/8T-4	1420 / 710		6.45 / 2.28		3.00 / 0.60	22685 / 11300	64 / 49	61 / 46	135
HTMF-71-6T-1 IE3	935	3.36	1.93		0.75	13410	50	48	109
HTMF-71-6T-1.5 IE3	930	4.73	2.72		1.10	16340	51	49	116
HTMF-80-4T-4 IE3	1455	11.01	6.33		3.00	27750	65	62	163
HTMF-80-4/8T-4	1420 / 710		6.45 / 2.28		3.00 / 0.60	27750 / 13820	65 / 50	62 / 47	165
HTMF-80-4T-5.5 IE3	1445		7.95	4.61	4.00	30330	66	63	163
HTMF-80-4/8T-5.5	1450 / 715		7.88 / 2.87		3.80 / 1.00	30330 / 14950	66 / 51	63 / 48	195
HTMF-80-6T-1.5 IE3	930	4.73	2.72		1.10	19435	54	52	181
HTMF-80-6T-2 IE3	950	6.25	3.62		1.50	22165	55	53	185
HTMF-80-6T-3 IE3	960	9.78	5.62		2.20	24890	56	54	191
HTMF-80-8T-1	710	5.06	2.92		0.75	16375	53	52	151
HTMF-90-4T-5.5 IE3	1445		7.95	4.61	4.00	35200	71	68	208
HTMF-90-4/8T-5.5	1450 / 715		7.88 / 2.87		3.80 / 1.00	35200 / 17360	71 / 56	68 / 53	238
HTMF-90-4T-7.5 IE3	1455		10.40	6.04	5.50	38535	73	70	240
HTMF-90-4/8T-7.5	1450 / 720		11.40 / 3.86		5.50 / 1.10	38535 / 19130	73 / 58	70 / 55	243
HTMF-90-4T-10 IE3	1460		14.20	8.17	7.50	41410	74	71	244
HTMF-90-4/8T-10	1450 / 720		15.10 / 5.16		7.50 / 1.50	41410 / 20560	74 / 59	71 / 56	243
HTMF-90-6T-3 IE3	960	9.78	5.62		2.20	29290	60	58	205
HTMF-90-6/12T-3	900 / 455		5.62 / 3.32		2.20 / 0.55	29290 / 14800	60 / 45	58 / 43	245
HTMF-90-6T-4 IE3	970	12.80	6.36		3.00	32040	61	59	235
HTMF-90-6/12T-4	900 / 450		7.37 / 3.53		2.80 / 0.70	32040 / 16020	61 / 46	59 / 44	245
HTMF-90-8T-1	710	5.06	2.92		0.75	17060	53	52	196
HTMF-90-8T-2	700	7.32	4.21		1.50	19635	55	54	208
HTMF-100-4T-7.5 IE3	1455		10.40	6.04	5.50	41060	76	73	265
HTMF-100-4/8T-7.5	1450 / 720		11.40 / 3.86		5.50 / 1.10	41060 / 20390	76 / 61	73 / 58	269
HTMF-100-4T-10 IE3	1460		14.20	8.17	7.50	47645	77	74	269
HTMF-100-4/8T-10	1450 / 720		15.10 / 5.16		7.50 / 1.50	44590 / 22140	76 / 61	73 / 58	269
HTMF-100-4T-15 IE3	1460		20.70	11.99	11.00	51375	78	75	332
HTMF-100-4/8T-14	1460 / 725		20.70 / 7.19		11.00 / 3.00	48400 / 24000	77 / 62	74 / 59	301
HTMF-100-6T-3 IE3	960	9.78	5.62		2.20	32600	66	64	231
HTMF-100-6/12T-3	900 / 455		5.62 / 3.32		2.20 / 0.55	32600 / 16470	66 / 51	64 / 49	271
HTMF-100-6T-4 IE3	970	12.80	6.36		3.00	35500	67	65	260
HTMF-100-6/12T-4	900 / 450		7.37 / 3.53		2.80 / 0.70	35500 / 17750	67 / 52	65 / 50	271
HTMF-100-6T-5.5 IE3	970		8.37	4.82	4.00	40035	68	66	277
HTMF-100-6/12T-5.5	900 / 445		9.54 / 4.27		3.80 / 1.00	40035 / 19710	68 / 53	66 / 51	289
HTMF-100-8T-3	705	9.30	5.35		2.20	26600	61	60	260
HTMF-100-8T-4	705	12.50	7.21		3.00	28900	62	61	270

Technical characteristics

Model	Speed (r/min)	Maximum admissible current (A)			Installed power (kW)	Maximum flow rate (m ³ /h)	Sound pressure level ¹ dB (A)		Approx. weight (Kg)
		230V	400V	690V			Inlet	Exhaust	
HTMF-THT-125-4T/6-15 IE3	1460		20.70	11.99	11.00	66810	69	66	388
HTMF-THT-125-4T/6-20 IE3	1460		27.80	16.03	15.00	72900	69	66	410
HTMF-THT-125-4T/9-20 IE3	1460		27.80	16.03	15.00	76320	68	64	425
HTMF-THT-125-6T/6-5.5 IE3	970		8.37	4.82	4.00	47770	56	54	347
HTMF-THT-125-6T/6-7.5 IE3	970		12.30	7.07	5.50	55600	56	54	384
HTMF-THT-125-6T/6-10 IE3	970		15.20	8.83	7.50	66180	58	56	393
HTMF-THT-125-6T/6-15 IE3	970		22.50	13.07	11.00	76380	60	58	415
HTMF-THT-125-6T/9-7.5 IE3	970		12.30	7.07	5.50	50000	57	55	399
HTMF-THT-125-6T/9-10 IE3	970		15.20	8.83	7.50	59340	57	55	408
HTMF-THT-125-6T/9-15 IE3	970		22.50	13.07	11.00	71890	60	58	430
HTMF-THT-125-6T/9-20 IE3	970		29.00	16.78	15.00	83660	63	61	475
HTMF-THT-125-8T/6-4	705	12.50	7.21		3.00	47510	48	47	384
HTMF-THT-125-8T/6-5.5	720		9.84	5.70	4.00	52780	50	49	404
HTMF-THT-125-8T/6-7.5	720		13.17	7.59	5.50	60410	52	51	416
HTMF-THT-125-8T/6-10	720		17.40	10.10	7.50	66030	53	52	424
HTMF-THT-125-8T/9-5.5	720		9.84	5.70	4.00	51340	50	49	419
HTMF-THT-125-8T/9-7.5	720		13.17	7.59	5.50	54490	53	52	431
HTMF-THT-125-8T/9-10	720		17.40	10.10	7.50	65670	55	54	439
HTMF-THT-125-8T/9-15	730		23.30	13.50	11.00	73880	56	55	472

¹ The noise level values are pressures in dB(A) measured at a distance of 10 metres in a free field.



Erp. (Energy Related Products)

Information on Directive 2009/125/EC can be downloaded from the SODECA website or the QuickFan selector programme.

Acoustic characteristics

Sound power spectrum Lw(A) in dB(A) per Hz frequency band

Values measured at inlet with maximum flow rate

	63	125	250	500	1000	2000	4000	8000
56-4-1	46	67	74	79	82	78	71	60
56-4-1.5	47	68	75	80	83	79	72	61
56-8-1.5 (2V)	31	52	59	64	67	63	56	45
56-6-0.75	35	56	63	68	71	67	60	49
63-4-1.5	49	70	77	82	85	81	74	63
63-8-1.5 (2V)	33	54	61	66	69	65	58	47
63-4-2	50	71	78	83	86	82	75	64
63-8-2 (2V)	35	56	63	68	71	67	60	49
63-4-3	51	72	79	84	87	83	76	65
63-8-3 (2V)	36	57	64	69	72	68	61	50
63-6-0.75	40	61	68	73	76	72	65	54
63-6-1	41	62	69	74	77	73	66	55
71-4-2	53	74	81	86	89	85	78	67
71-8-2 (2V)	38	59	66	71	74	70	63	52
71-4-3	55	76	83	88	91	87	80	69
71-8-3 (2V)	40	61	68	73	76	72	65	54
71-4-4	56	77	84	89	92	88	81	70
71-8-4 (2V)	41	62	69	74	77	73	66	55
71-6-1	42	63	70	75	78	74	67	56
71-6-1.5	43	64	71	76	79	75	68	57
80-4-4	57	78	85	90	93	89	82	71
80-8-4 (2V)	42	63	70	75	78	74	67	56
80-4-5.5	58	79	86	91	94	90	83	72
80-8-5.5 (2V)	43	64	71	76	79	75	68	57
80-6-1.5	46	67	74	79	82	78	71	60
80-6-2	47	68	75	80	83	79	72	61

Values measured at exhaust with maximum flow rate

	63	125	250	500	1000	2000	4000	8000
56-4-1	43	64	71	76	79	75	68	57
56-4-1.5	44	65	72	77	80	76	69	58
56-8-1.5 (2V)	28	49	56	61	64	60	53	42
56-6-0.75	33	54	61	66	69	65	58	47
63-4-1.5	46	67	74	79	82	78	71	60
63-8-1.5 (2V)	30	51	58	63	66	62	55	44
63-4-2	47	68	75	80	83	79	72	61
63-8-2 (2V)	32	53	60	65	68	64	57	46
63-4-3	48	69	76	81	84	80	73	62
63-8-3 (2V)	33	54	61	66	69	65	58	47
63-6-0.75	38	59	66	71	74	70	63	52
63-6-1	39	60	67	72	75	71	64	53
71-4-2	50	71	78	83	86	82	75	64
71-8-2 (2V)	35	56	63	68	71	67	60	49
71-4-3	52	73	80	85	88	84	77	66
71-8-3 (2V)	37	58	65	70	73	69	62	51
71-4-4	53	74	81	86	89	85	78	67
71-8-4 (2V)	38	59	66	71	74	70	63	52
71-6-1	40	61	68	73	76	72	65	54
71-6-1.5	41	62	69	74	77	73	66	55
80-4-4	54	75	82	87	90	86	79	68
80-8-4 (2V)	39	60	67	72	75	71	64	53
80-4-5.5	55	76	83	88	91	87	80	69
80-8-5.5 (2V)	40	61	68	73	76	72	65	54
80-6-1.5	44	65	72	77	80	76	69	58
80-6-2	45	66	73	78	81	77	70	59

Acoustic characteristics

Sound power spectrum Lw(A) in dB(A) per Hz frequency band

Values measured at inlet with maximum flow rate

	63	125	250	500	1000	2000	4000	8000
80-6-3	48	69	76	81	84	80	73	62
80-8-1	45	66	73	78	81	77	70	59
90-4-5.5	63	84	91	96	99	95	88	77
90-8-5.5 (2V)	48	69	76	81	84	80	73	62
90-4-7.5	65	86	93	98	101	97	90	79
90-8-7.5 (2V)	50	71	78	83	86	82	75	64
90-4-10	66	87	94	99	102	98	91	80
90-8-10 (2V)	51	72	79	84	87	83	76	65
90-6-3	52	73	80	85	88	84	77	66
90-12-3 (2V)	37	58	65	70	73	69	62	51
90-6-4	53	74	81	86	89	85	78	67
90-12-4 (2V)	38	59	66	71	74	70	63	52
90-8-1	45	66	73	78	81	77	70	59
90-8-2	47	68	75	80	83	79	72	61
100-4-7.5	68	89	96	101	104	100	93	82
100-8-7.5 (2V)	53	74	81	86	89	85	78	67
100-4-10	68	89	96	101	104	100	93	82
100-8-10 (2V)	53	74	81	86	89	85	78	67
100-4-14	69	90	97	102	105	101	94	83
100-8-14 (2V)	54	75	82	87	90	86	79	68
100-4-15	70	91	98	103	106	102	95	84
100-6-3	58	79	86	91	94	90	83	72
100-12-3 (2V)	43	64	71	76	79	75	68	57
100-6-4	59	80	87	92	95	91	84	73
100-12-4 (2V)	44	65	72	77	80	76	69	58
100-6-5.5	60	81	88	93	96	92	85	74
100-12-5.5 (2V)	45	66	73	78	81	77	70	59
100-8-3	53	74	81	86	89	85	78	67
100-8-4	54	75	82	87	90	86	79	68
125-4/6-15	63	72	87	94	97	91	85	81
125-4/6-20	63	72	87	94	97	91	85	81
125-4/9-20	62	71	87	93	95	89	84	80
125-6/6-5.5	56	66	78	81	83	79	68	64
125-6/6-7.5	56	66	78	81	83	79	68	64
125-6/6-10	58	68	80	83	85	81	70	66
125-6/6-15	60	70	82	85	87	83	72	68
125-6/9-7.5	54	65	79	83	83	81	70	66
125-6/9-10	54	65	79	83	83	81	70	66
125-6/9-15	57	68	82	86	86	84	73	69
125-6/9-20	60	71	85	89	89	87	76	72
125-8/6-4	50	59	70	75	75	69	58	54
125-8/6-5.5	52	61	72	77	77	71	60	56
125-8/6-7.5	54	63	74	79	79	73	62	58
125-8/6-10	55	64	75	80	80	74	63	59
125-8/9-5.5	49	61	70	76	78	72	61	57
125-8/9-7.5	52	64	73	79	81	75	64	60
125-8/9-10	54	66	75	81	83	77	66	62
125-8/9-15	55	67	76	82	84	78	67	63

Values measured at exhaust with maximum flow rate

	63	125	250	500	1000	2000	4000	8000
80-6-3	46	67	74	79	82	78	71	60
80-8-1	44	65	72	77	80	76	69	58
90-4-5.5	60	81	88	93	96	92	85	74
90-8-5.5 (2V)	45	66	73	78	81	77	70	59
90-4-7.5	62	83	90	95	98	94	87	76
90-8-7.5 (2V)	47	68	75	80	83	79	72	61
90-4-10	63	84	91	96	99	95	88	77
90-8-10 (2V)	48	69	76	81	84	80	73	62
90-6-3	50	71	78	83	86	82	75	64
90-12-3 (2V)	35	56	63	68	71	67	60	49
90-6-4	51	72	79	84	87	83	76	65
90-12-4 (2V)	36	57	64	69	72	68	61	50
90-8-1	44	65	72	77	80	76	69	58
90-8-2	46	67	74	79	82	78	71	60
100-4-7.5	65	86	93	98	101	97	90	79
100-8-7.5 (2V)	50	71	78	83	86	82	75	64
100-4-10	65	86	93	98	101	97	90	79
100-8-10 (2V)	50	71	78	83	86	82	75	64
100-4-14	66	87	94	99	102	98	91	80
100-8-14 (2V)	51	72	79	84	87	83	76	65
100-4-15	67	88	95	100	103	99	92	81
100-6-3	56	77	84	89	92	88	81	70
100-12-3 (2V)	41	62	69	74	77	73	66	55
100-6-4	57	78	85	90	93	89	82	71
100-12-4 (2V)	42	63	70	75	78	74	67	56
100-6-5.5	58	79	86	91	94	90	83	72
100-12-5.5 (2V)	43	64	71	76	79	75	68	57
100-8-3	52	73	80	85	88	84	77	66
100-8-4	53	74	81	86	89	85	78	67
125-4/6-15	60	69	84	91	94	88	82	78
125-4/6-20	60	69	84	91	94	88	82	78
125-4/9-20	59	68	84	90	92	86	81	77
125-6/6-5.5	54	64	76	79	81	77	66	62
125-6/6-7.5	54	64	76	79	81	77	66	62
125-6/6-10	56	66	78	81	83	79	68	64
125-6/6-15	58	68	80	83	85	81	70	66
125-6/9-7.5	52	63	77	81	81	79	68	64
125-6/9-10	52	63	77	81	81	79	68	64
125-6/9-15	55	66	80	84	84	82	71	67
125-6/9-20	58	69	83	87	87	85	74	70
125-8/6-4	49	58	69	74	74	68	57	53
125-8/6-5.5	51	60	71	76	76	70	59	55
125-8/6-7.5	53	62	73	78	78	72	61	57
125-8/6-10	54	63	74	79	79	73	62	58
125-8/9-5.5	48	60	69	75	77	71	60	56
125-8/9-7.5	51	63	72	78	80	74	63	59
125-8/9-10	53	65	74	80	82	76	65	61
125-8/9-15	54	66	75	81	83	77	66	62

Dimensions mm

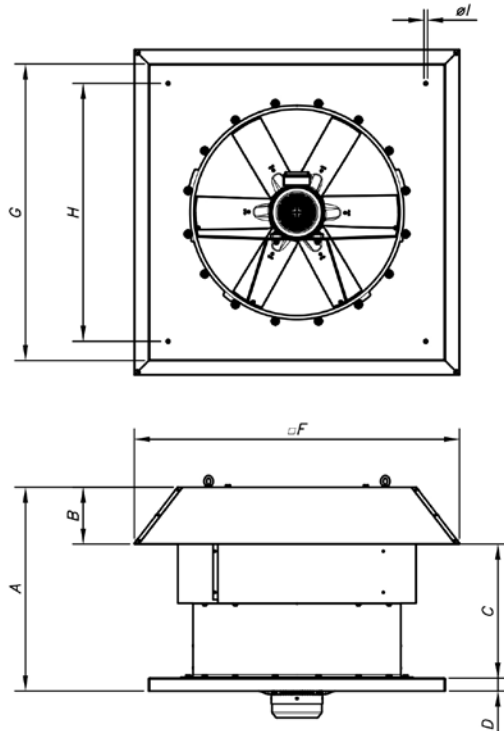

	A	B	C	D	F	G	H	ØI
HTMF-56	650	185	425	40	960	900	750	14
HTMF-63	680	215	425	40	1092	1000	850	14
HTMF-71	759	195	524	40	1120	1000	850	14
HTMF-80	790	216	524	50	1252	1150	1000	14
HTMF-90	920	232	638	50	1380	1150	1000	14
HTMF-100	1055	252	753	50	1527	1250	1100	14
HTMF-125	1170	311	809	50	1803	1425	1275	17

Characteristic curves

Q= Flow rate in m³/h, m³/s and cfm

Pe= Static pressure in mm H₂O, Pa and inwg

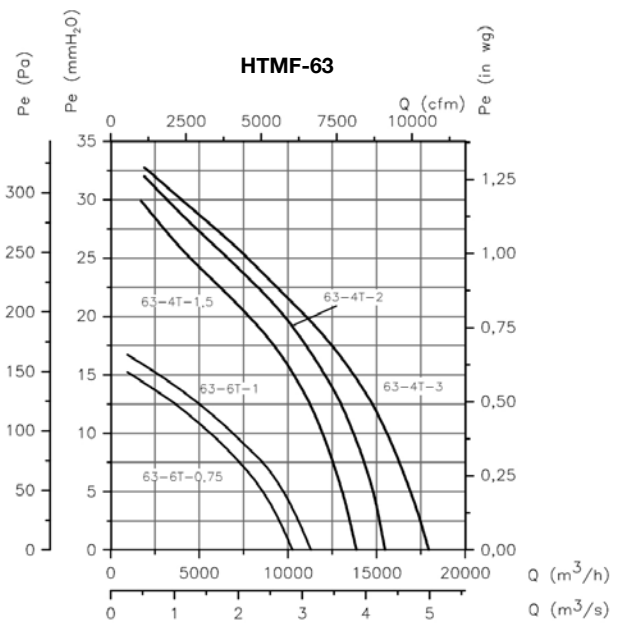
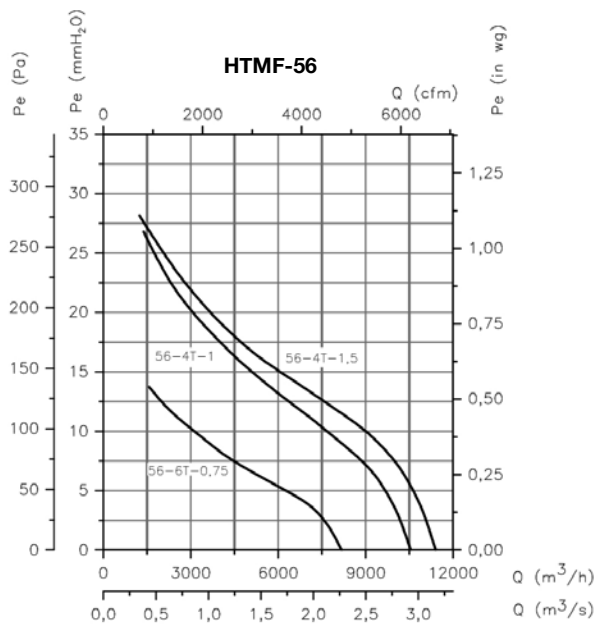

Characteristic curves

Q= Flow rate in m³/h, m³/s and cfm

Pe= Static pressure in mm H₂O, Pa and in wg

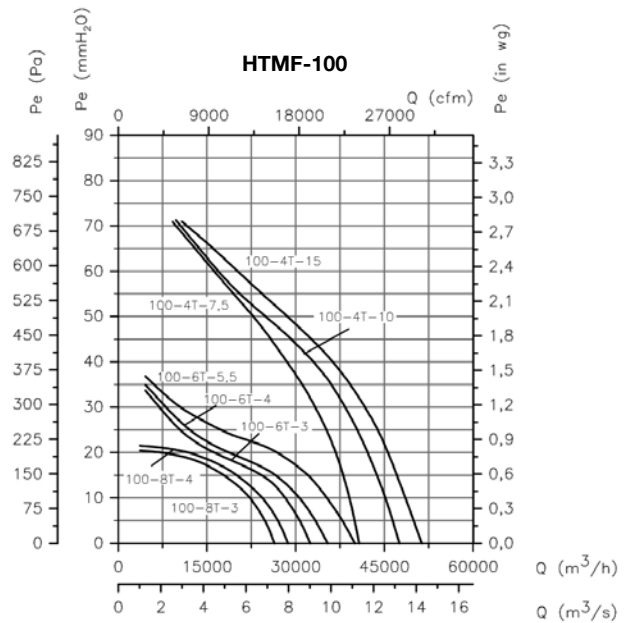
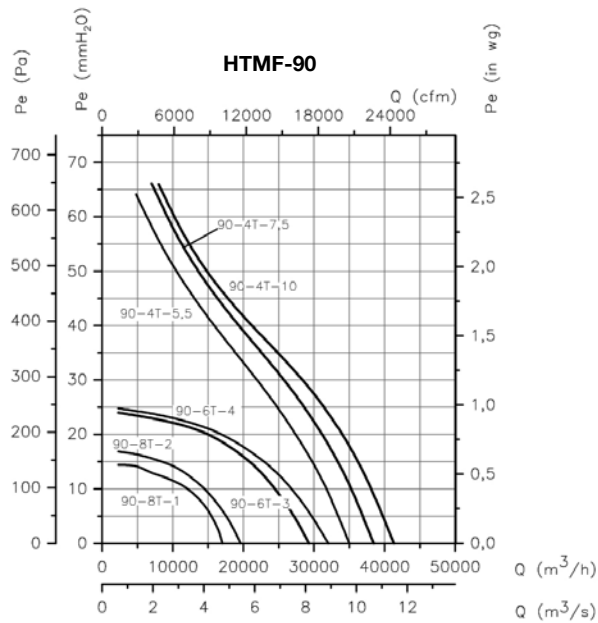
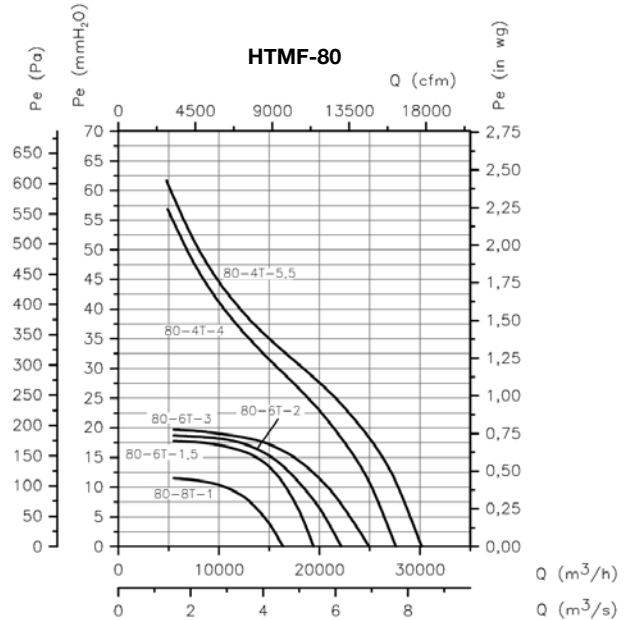
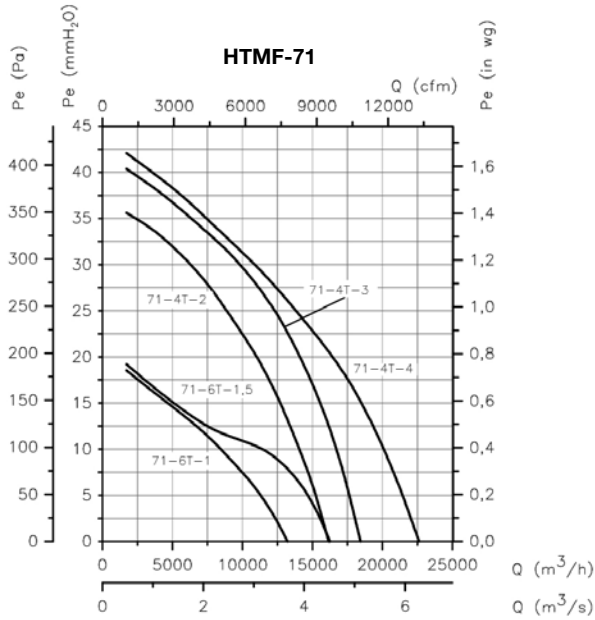

Characteristic curves

Q= Flow rate in m³/h, m³/s and cfm

Pe= Static pressure in mm H₂O, Pa and inwg

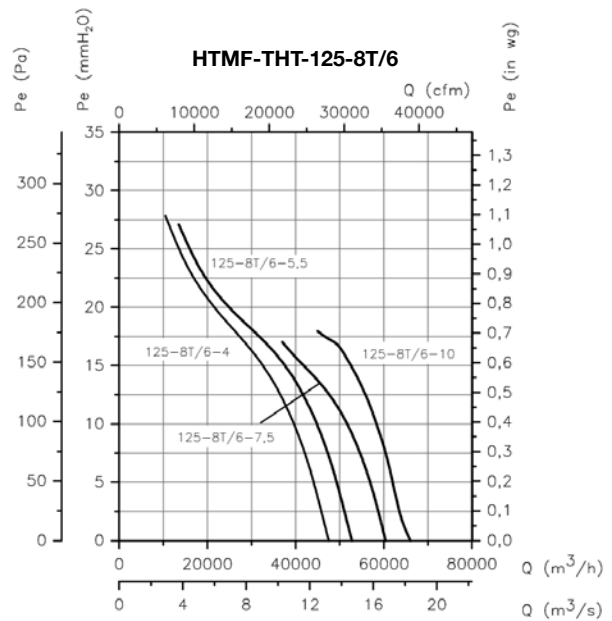
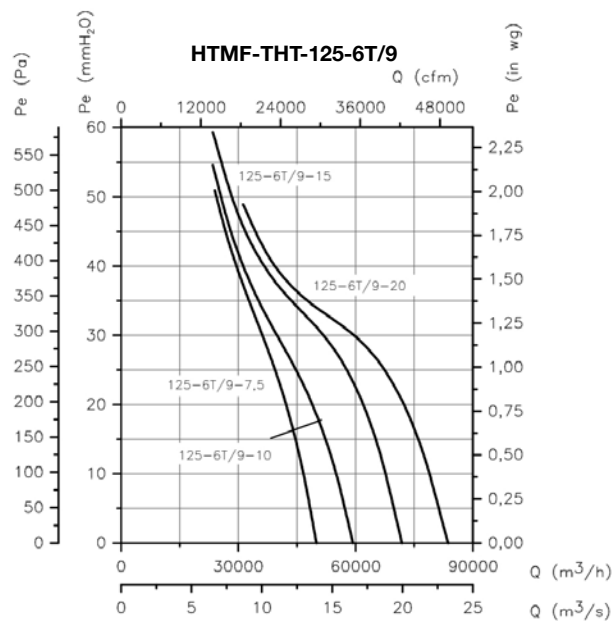
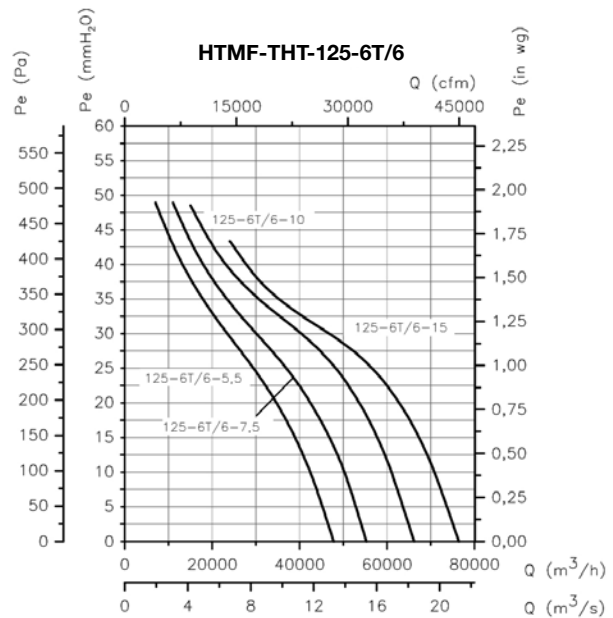
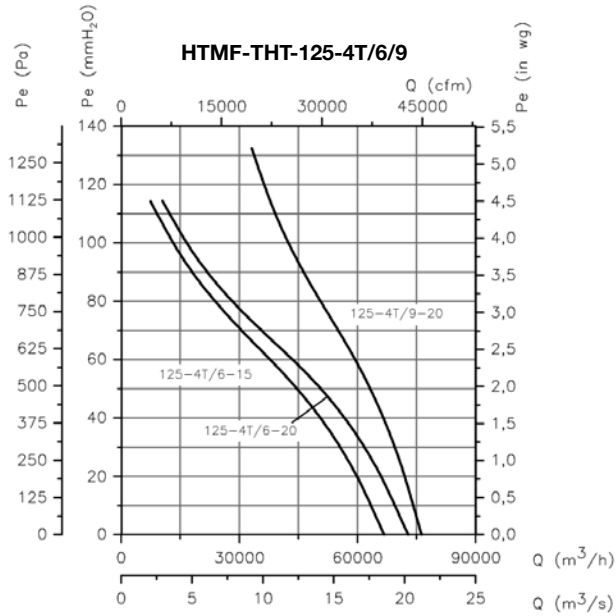

Characteristic curves

Q= Flow rate in m³/h, m³/s and cfm

Pe= Static pressure in mm H₂O, Pa and inwg

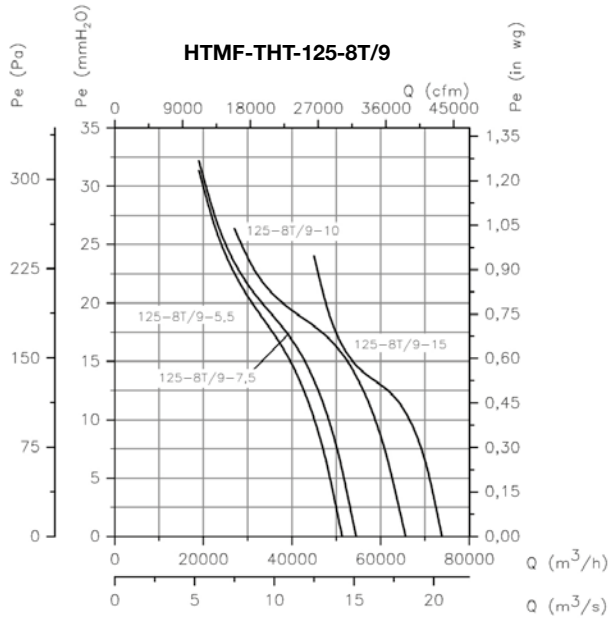

Sound pressure variation depending on distance

The noise level may vary depending on the roof or tile structure.

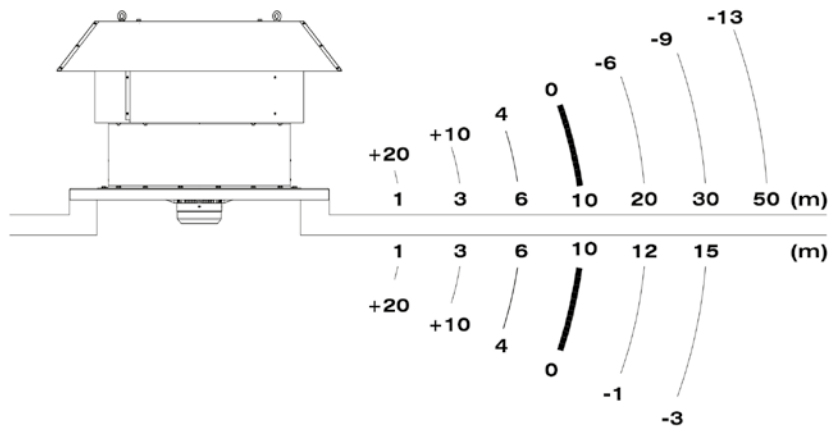

Accessories



INT



IAT



CABLE BOX



C2V



VSD3/A-RFT
- VSD1/A-RFM



CENTRAL CO



AET

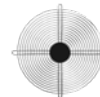

RT

THT/ROOF

400 °C/2h and 300 °C/2h roof mounted axial extract fans with vertical air outlets



Roof mounted axial extract fans with vertical air outlets, for immersed operation in fire risk zones, designed for smoke extraction in industrial or similar buildings.

Fan:

- Support base in galvanized steel sheet and anti-corrosive treatment.
- Adjustable cast aluminum impeller.
- Protection grid against contacts according to UNE-EN ISO 12499.
- Non-return damper in aluminum sheet to prevent the entry of water when the fan is not running.
- Approved in accordance with standard EN 12101-3, with certifications no.: 0370-CPR-3080 (F400) and 0370-CPR-3056 (F300).
- Airflow direction from motor to impeller.

Motor:

- Motors with IE3 efficiency for powers equal to or greater than 0.75 kW, except single-phase, 2-speed and 8-pole.

- Class H motors for S1 continuous operation and S2 emergency use. With ball bearings and IP55 protection.
- Three-phase 230/400 V 50 Hz (up to 3 kW) and 400/690 V 50 Hz (powers greater than 3 kW).
- Maximum temperature of air to be carried: S1 -25 °C +40 °C continuous service, also suitable for warm climates with temperatures up to 50 °C. S2 operation, 300 °C/2h, 400 °C/2h.

Finish:

- Anti-corrosive finish in polyester resin, polymerised at 190 °C, after degreasing with phosphate-free nanotechnology treatment.

On request:

- Fans with 2 speed motor.
- 2 and 8 pole fans according to diameter.

Order code

From size 40 to size 100

THT/ROOF	—	56	—	4T	—	2	—	F400
↓		↓		↓	↘	↓		↓
THT/ROOF: 400 °C/2h and 300 °C/2h roof mounted axial extract fans with vertical air outlets		Impeller diameter in cm		Number of motor poles 4=1500 r/min 50 Hz 6=1000 r/min 50 Hz	T = Three-phase	Motor power (HP)		F300: 300 °C/2h approved F400: 400 °C/2h approved

Size 125

THT/ROOF	—	125	—	4T	/	9	—	25	—	F400
↓		↓		↓	↘	↓		↓		↓
THT/ROOF: 400 °C/2h and 300 °C/2h roof mounted axial extract fans with vertical air outlets		Impeller diameter in cm		Number of motor poles 4=1500 r/min 50 Hz 6=1000 r/min 50 Hz	T = Three-phase	Number of blades: 6 blades 9 blades		Motor power (HP)		F300: 300 °C/2h approved F400: 400 °C/2h approved

Technical characteristics

Model	Speed (r/min)	Maximum admissible current (A)			Installed power (kW)	Blade tilt angle (°)	Maximum flow rate (m³/h)	Sound pressure level ¹ dB (A)		Approx. weight (Kg)
		230V	400V	690V				Inlet	Exhaust	
THT/ROOF-40-4T-0.75	1420	2.84	1.64		0.55	32	4800	45	44	39
THT/ROOF-40-6T-0.75	930	2.90	1.75		0.55	32	3150	36	35	44
THT/ROOF-45-4T-0.75	1420	2.84	1.64		0.55	36	7450	48	47	42
THT/ROOF-45-6T-0.75	930	2.90	1.75		0.55	30	4450	38	37	47
THT/ROOF-50-4T-1 IE3	1410	3.08	1.79		0.75	28	9730	50	49	51
THT/ROOF-50-6T-0.75	930	2.90	1.75		0.55	32	7000	42	41	54
THT/ROOF-56-4T-1 IE3	1410	3.08	1.79		0.75	22	11250	53	52	58
THT/ROOF-56-4T-1.5 IE3	1430	4.10	2.37		1.10	30	13600	53	52	58
THT/ROOF-56-4T-2 IE3	1435	5.89	3.38		1.50	36	15030	54	53	61
THT/ROOF-56-6T-0.75	930	2.90	1.75		0.55	38	10140	44	43	57
THT/ROOF-63-4T-1.5 IE3	1430	4.10	2.37		1.10	20	17800	56	55	67
THT/ROOF-63-4T-2 IE3	1435	5.89	3.38		1.50	24	19280	56	55	71
THT/ROOF-63-4T-3 IE3	1450	7.86	4.52		2.20	32	22150	58	57	76
THT/ROOF-63-4T-4 IE3	1455	11.01	6.33		3.00	38	24240	59	58	85
THT/ROOF-63-6T-0.75	930	2.90	1.75		0.55	28	13590	47	46	67
THT/ROOF-63-6T-1 IE3	935	3.36	1.93		0.75	38	15890	48	47	70
THT/ROOF-71-4T-2 IE3	1435	5.89	3.38		1.50	14	20900	60	59	78
THT/ROOF-71-4T-3 IE3	1450	7.86	4.52		2.20	22	25100	60	59	83
THT/ROOF-71-4T-4 IE3	1455	11.01	6.33		3.00	28	27480	60	59	92
THT/ROOF-71-6T-0.75	930	2.90	1.75		0.55	20	16100	50	49	74
THT/ROOF-71-6T-1 IE3	935	3.36	1.93		0.75	26	17300	50	49	77
THT/ROOF-71-6T-1.5 IE3	930	4.73	2.72		1.10	34	19930	51	50	83
THT/ROOF-80-4T-4 IE3	1455	11.01	6.33		3.00	16	30250	64	63	114
THT/ROOF-80-4T-5.5 IE3	1445		7.95	4.61	4.00	18	32750	63	62	121
THT/ROOF-80-6T-1.5 IE3	930	4.73	2.72		1.10	18	21450	53	52	105
THT/ROOF-80-6T-2 IE3	950	6.25	3.62		1.50	26	25950	54	53	114
THT/ROOF-80-6T-3 IE3	960	9.78	5.62		2.20	32	29930	55	54	120
THT/ROOF-90-4T-5.5 IE3	1445		7.95	4.61	4.00	12	38890	68	67	134
THT/ROOF-90-4T-7.5 IE3	1455		10.40	6.04	5.50	18	46140	67	66	161
THT/ROOF-90-4T-10 IE3	1460		14.20	8.17	7.50	22	50140	66	65	172
THT/ROOF-90-6T-2 IE3	950	6.25	3.62		1.50	16	28780	56	55	127
THT/ROOF-90-6T-3 IE3	960	9.78	5.62		2.20	24	34000	56	55	134
THT/ROOF-90-6T-4 IE3	970	12.80	6.36		3.00	30	38900	59	58	159
THT/ROOF-100-4T-7.5 IE3	1455		10.40	6.04	5.50	10	46850	72	71	172
THT/ROOF-100-4T-10 IE3	1460		14.20	8.17	7.50	16	57400	69	68	183
THT/ROOF-100-4T-15 IE3	1460		20.70	11.99	11.00	22	66300	69	68	236
THT/ROOF-100-4T-20 IE3	1460		27.80	16.03	15.00	28	76150	70	69	251
THT/ROOF-100-6T-3 IE3	960	9.78	5.62		2.20	16	37600	60	59	146
THT/ROOF-100-6T-4 IE3	970	12.80	6.36		3.00	20	41150	59	58	171
THT/ROOF-100-6T-5.5 IE3	970		8.37	4.82	4.00	26	47780	60	59	183
THT/ROOF-125-4T/6-25 IE3	1475		35.40	20.39	18.50	14	92550	70	69	413
THT/ROOF-125-4T/6-30 IE3	1475		42.20	24.44	22.00	16	98830	69	68	427
THT/ROOF-125-4T/6-40 IE3	1470		53.30	31.02	30.00	22	117450	69	68	507
THT/ROOF-125-4T/6-50 IE3	1480		66.80	38.70	37.00	26	131050	69	68	543
THT/ROOF-125-4T/9-25 IE3	1475		35.40	20.39	18.50	10	79650	77	76	422
THT/ROOF-125-4T/9-30 IE3	1475		42.20	24.44	22.00	12	88290	76	75	436
THT/ROOF-125-4T/9-40 IE3	1470		53.30	31.02	30.00	16	104040	75	74	516
THT/ROOF-125-4T/9-50 IE3	1480		66.80	38.70	37.00	20	118400	75	74	552
THT/ROOF-125-6T/6-5.5 IE3	970		8.37	4.82	4.00	10	51500	62	61	288
THT/ROOF-125-6T/6-7.5 IE3	970		12.30	7.07	5.50	14	60640	60	59	295
THT/ROOF-125-6T/6-10 IE3	970		15.20	8.83	7.50	20	72650	59	58	325
THT/ROOF-125-6T/6-15 IE3	970		22.50	13.07	11.00	26	85850	60	59	355
THT/ROOF-125-6T/6-20 IE3	970		29.00	16.78	15.00	30	92850	61	60	413
THT/ROOF-125-6T/9-10 IE3	970		15.20	8.83	7.50	14	63490	67	66	334
THT/ROOF-125-6T/9-15 IE3	970		22.50	13.07	11.00	20	77550	65	64	364
THT/ROOF-125-6T/9-20 IE3	970		29.00	16.78	15.00	26	92950	65	64	422

¹ The noise level values are pressures in dB(A) measured at a distance of 10 metres in a free field.



Erp. (Energy Related Products)

Information on Directive 2009/125/EC can be downloaded from the SODECA website or the QuickFan selector programme.

Acoustic characteristics

Sound power spectrum Lw(A) in dB(A) per Hz frequency band

Values measured at inlet with maximum flow rate

	63	125	250	500	1000	2000	4000	8000
40-4-0.75	37	53	63	70	71	68	67	68
40-6-0.75	28	44	54	61	62	59	58	59
45-4-0.75	47	59	67	73	73	73	68	60
45-6-0.75	37	49	57	63	63	63	58	50
50-4-1	49	61	69	75	75	75	70	62
50-6-0.75	41	53	61	67	67	67	62	54
56-4-1	51	63	72	78	78	78	72	64
56-4-1.5	51	63	72	78	78	78	72	64
56-4-2	52	64	73	79	79	79	73	65
56-6-0.75	45	55	65	69	70	68	61	53
63-4-1.5	47	63	75	81	83	80	73	65
63-4-2	54	66	75	81	81	81	75	67
63-4-3	56	68	77	83	83	83	77	69
63-4-4	57	69	78	84	84	84	78	70
63-6-0.75	48	58	68	72	73	71	64	56
63-6-1	49	59	69	73	74	72	65	57
71-4-2	56	72	79	85	85	85	81	73
71-4-3	56	72	79	85	85	85	81	73
71-4-4	63	75	79	85	85	86	83	75
71-6-0.75	46	53	73	76	76	71	63	55
71-6-1	46	64	73	76	76	71	64	55
71-6-1.5	47	65	74	77	77	72	65	56
80-4-4	54	70	83	90	90	87	81	73
80-4-5.5	53	69	82	89	89	86	80	72
80-6-1.5	53	68	75	78	79	76	70	62
80-6-2	59	69	75	79	80	78	73	65
80-6-3	60	70	76	80	81	79	74	66
90-4-5.5	60	76	87	93	94	92	87	79
90-4-7.5	59	75	86	92	93	91	86	78
90-4-10	58	74	85	91	92	90	85	77
90-6-2	52	67	78	82	82	78	71	63
90-6-3	52	67	78	82	82	78	71	63
90-6-4	60	70	80	85	85	82	76	68
100-4-7.5	67	83	90	97	98	96	92	84
100-4-10	64	80	87	94	95	93	89	81
100-4-15	71	83	87	93	94	94	91	83
100-4-20	72	84	88	94	95	95	92	84
100-6-3	57	72	82	85	86	83	75	67
100-6-4	56	71	81	84	85	82	74	66
100-6-5.5	57	72	82	85	86	83	75	67
125-4/6-25	65	81	88	95	96	94	90	82
125-4/6-30	64	80	87	94	95	93	89	81
125-4/6-40	71	83	87	93	94	94	91	83
125-4/6-50	71	83	87	93	94	94	91	83
125-4/9-25	67	81	94	102	104	101	96	88
125-4/9-30	66	80	93	101	103	100	95	87
125-4/9-40	65	79	92	100	102	99	94	86
125-4/9-50	65	79	92	100	102	99	94	86
125-6/6-5.5	59	74	84	87	88	85	77	69
125-6/6-7.5	57	72	82	85	86	83	75	67
125-6/6-10	56	71	81	84	85	82	74	66
125-6/6-15	57	72	82	85	86	83	75	67
125-6/6-20	58	73	83	86	87	84	76	68
125-6/9-10	61	76	87	93	94	88	84	77
125-6/9-15	59	74	85	91	92	86	82	75
125-6/9-20	59	74	85	91	92	86	82	75

Values measured at exhaust with maximum flow rate

	63	125	250	500	1000	2000	4000	8000
40-4-0.75	36	52	62	69	70	67	66	67
40-6-0.75	27	43	53	60	61	58	57	58
45-4-0.75	46	58	66	72	72	72	67	59
45-6-0.75	36	48	56	62	62	62	57	49
50-4-1	48	60	68	74	74	74	69	61
50-6-0.75	40	52	60	66	66	66	61	53
56-4-1	50	62	71	77	77	77	71	63
56-4-1.5	50	62	71	77	77	77	71	63
56-4-2	51	63	72	78	78	78	72	64
56-6-0.75	44	54	64	68	69	67	60	52
63-4-1.5	46	62	74	80	82	79	72	64
63-4-2	53	65	74	80	80	80	74	66
63-4-3	55	67	76	82	82	82	76	68
63-4-4	56	68	77	83	83	83	77	69
63-6-0.75	47	57	67	71	72	70	63	55
63-6-1	48	58	68	72	73	71	64	56
71-4-2	55	71	78	84	84	84	80	72
71-4-3	55	71	78	84	84	84	80	72
71-4-4	62	74	78	84	84	85	82	74
71-6-0.75	45	52	72	75	75	70	62	54
71-6-1	45	63	72	75	75	70	63	54
71-6-1.5	46	64	73	76	76	71	64	55
80-4-4	53	69	82	89	89	86	80	72
80-4-5.5	52	68	81	88	88	85	79	71
80-6-1.5	52	67	74	77	78	75	69	61
80-6-2	58	68	74	78	79	77	72	64
80-6-3	59	69	75	79	80	78	73	65
90-4-5.5	59	75	86	92	93	91	86	78
90-4-7.5	58	74	85	91	92	90	85	77
90-4-10	57	73	84	90	91	89	84	76
90-6-2	51	66	77	81	81	77	70	62
90-6-3	51	66	77	81	81	77	70	62
90-6-4	59	69	79	84	84	81	75	67
100-4-7.5	66	82	89	96	97	95	91	83
100-4-10	63	79	86	93	94	92	88	80
100-4-15	70	82	86	92	93	93	90	82
100-4-20	71	83	87	93	94	94	91	83
100-6-3	56	71	81	84	85	82	74	66
100-6-4	55	70	80	83	84	81	73	65
100-6-5.5	56	71	81	84	85	82	74	66
125-4/6-25	64	80	87	94	95	93	89	81
125-4/6-30	63	79	86	93	94	92	88	80
125-4/6-40	70	82	86	92	93	93	90	82
125-4/6-50	70	82	86	92	93	93	90	82
125-4/9-25	66	80	93	101	103	100	95	87
125-4/9-30	65	79	92	100	102	99	94	86
125-4/9-40	64	78	91	99	101	98	93	85
125-4/9-50	64	78	91	99	101	98	93	85
125-6/6-5.5	58	73	83	86	87	84	76	68
125-6/6-7.5	56	71	81	84	85	82	74	66
125-6/6-10	55	70	80	83	84	81	73	65
125-6/6-15	56	71	81	84	85	82	74	66
125-6/6-20	57	72	82	85	86	83	75	67
125-6/9-10	60	75	86	92	93	87	83	76
125-6/9-15	58	73	84	90	91	85	81	74
125-6/9-20	58	73	84	90	91	85	81	74

Dimensions mm

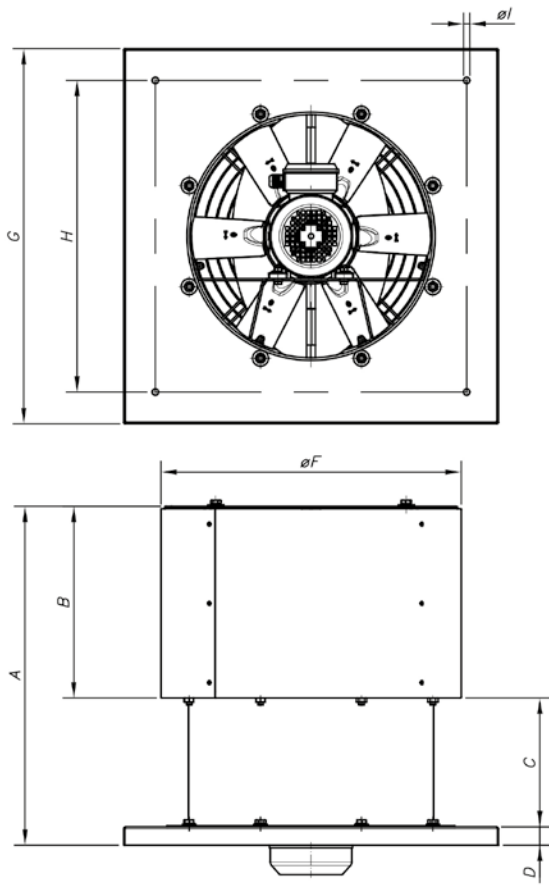

	A	B	C	D	ØF	G	H	ØI
THT/ROOF-40	628	349	244	35	519	630	530	12
THT/ROOF-45	642	363	244	35	569	710	590	12
THT/ROOF-50	679	400	244	35	626	900	750	12
THT/ROOF-56	710	426	244	40	686	900	750	14
THT/ROOF-63	747	463	244	40	753	1000	850	14
THT/ROOF-71	830	498	292	40	833	1000	850	14
THT/ROOF-80	887	545	292	50	923	1150	1000	14
THT/ROOF-90	989	601	338	50	1031	1150	1000	14
THT/ROOF-100	1136	648	438	50	1128	1250	1100	14
THT/ROOF-125	1313	775	488	50	1386	1425	1275	17

Characteristic curves

See series characteristic curves: THT

Accessories



INT



IAT



CABLE BOX



C2V



VSD3/A-RFT
- VSD1/A-RFM



CENTRAL CO



AET

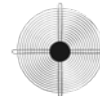

RT

CJBDT

Extract units with direct drive, to work inside the fire zone 400 °C/2h and 300 °C/2h



400 °C/2h extractor fan units and double inlet centrifugal extractor fans with direct drive motors for immersed operation in fire risk zones. With the option of a single-phase motor.

Fan:

- Galvanized steel sheet casing.
- Forward curved impeller in galvanized sheet steel.
- External terminal box.
- Vibration isolators.
- Approved in accordance with standard EN 12101-3, with certificate no.: 0370-CPR-0580.

Motor:

- Class H motors for S1 continuous operation and S2 emergency use. With ball bearings, IP55 protection and 1 or 2 speeds, depending on model.

- Single-phase 230 V 50 Hz and three-phase 230/400 V 50 Hz (up to 3 kW) and 400/690 V 50 Hz (powers greater than 3 kW).
- Maximum temperature of air to be carried: S1 continuous operation -20 °C +60 °C, S2 operation 300 °C/2h, 400 °C/2h.

Finish:

- Anti-corrosive in galvanized steel sheet.

On request:

- Fans with circular outlet.
- Fans with vertical outlet.

Order code

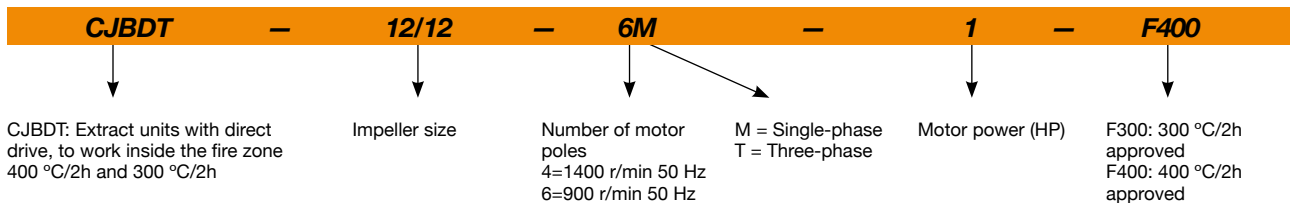

Technical characteristics

Model	Speed (r/min)	Maximum admissible current (A)			Installed power (kW)	Maximum flow rate (m³/h)	Sound pressure level ¹ dB (A)	Approx. weight (Kg)
		230V	400V	690V				
CJBDT-9/9-4T	1420	2.90	1.70		0.55	3000	57	44
CJBDT-9/9-4M	1410	4.10			0.55	3000	57	44
CJBDT-10/10-4T	1420	2.90	1.70		0.55	3450	60	49
CJBDT-10/10-4M	1410	4.10			0.55	3450	60	49
CJBDT-12/12-6T-1	945	4.40	2.60		0.75	4800	57	69
CJBDT-12/12-6M-1	920	5.80			0.75	4800	57	69
CJBDT-12/12-6T-1.5	970	6.40	3.70		1.10	6200	58	71
CJBDT-12/12-6M-1.5	920	8.40			1.10	6200	58	71
CJBDT-15/15-6T	950	10.30	5.90		2.20	8250	62	110
CJBDT-18/18-6T	970		11.00	6.35	4.00	11800	64	175

¹ Irradiated sound pressure level in dB(A) at a distance of 3 m.



Erp. (Energy Related Products)

Information on Directive 2009/125/EC can be downloaded from the SODECA website or the QuickFan selector programme.

Acoustic characteristics

Irradiated sound power spectrum $L_w(A)$ in dB(A) per Hz frequency band

	63	125	250	500	1000	2000	4000	8000		63	125	250	500	1000	2000	4000	8000
CJBDT-9/9-4-0.75	51	66	70	69	68	65	65	55	CJBDT-12/12-6-1.5	52	67	71	70	69	66	66	56
CJBDT-10/10-4-0.75	54	69	73	72	71	68	68	58	CJBDT-15/15-6-3	63	72	74	76	71	70	64	55
CJBDT-12/12-6-1	51	66	70	69	68	65	65	55	CJBDT-18/18-6-5.5	64	74	76	78	73	72	66	57

Dimensions mm

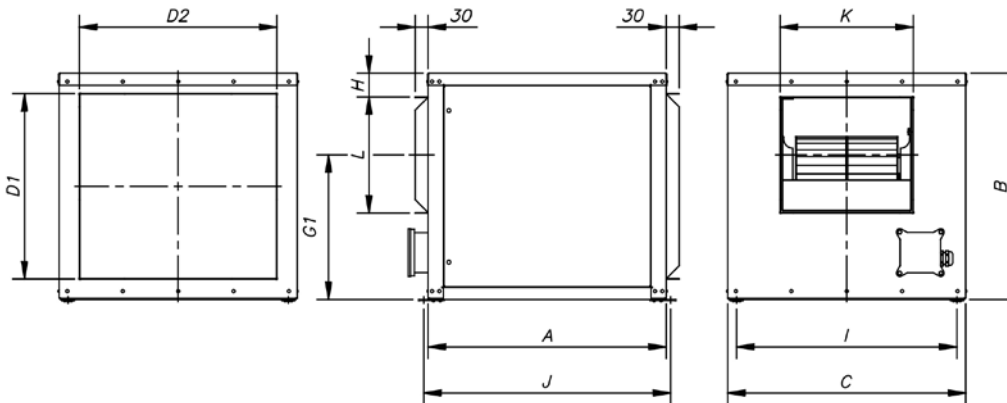

	A	B	C	D1	D2	G1	H	I	J	K	L
CJBDT-9/9	550	522	550	428	456	333.5	54.5	509	570	308	268
CJBDT-10/10	600	575	600	480	505	361.5	65.5	559	620	334	296
CJBDT-12/12	650	650	700	555	605	418	57.5	659	670	395	349
CJBDT-15/15	755	755	800	660	705	485	64	759	775	478	412
CJBDT-18/18	1000	900	1000	804	904	585	69.5	934	1041	550	491

Characteristic curves

Q= Flow rate in m³/h, m³/s and cfm

Pe= Static pressure in mm H₂O, Pa and inwg

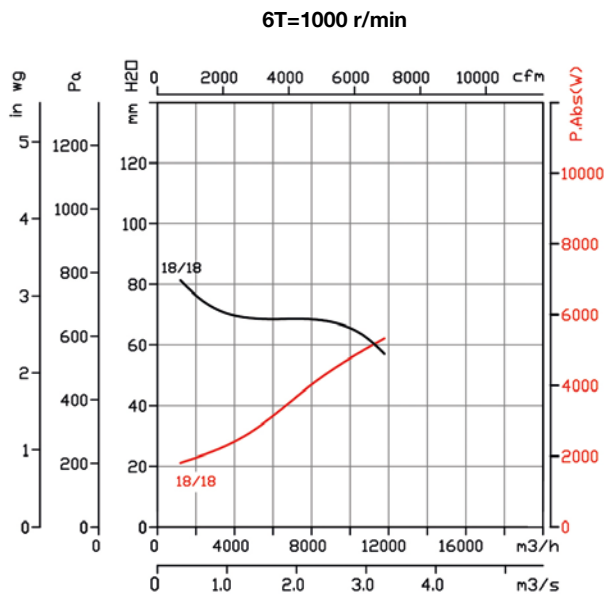
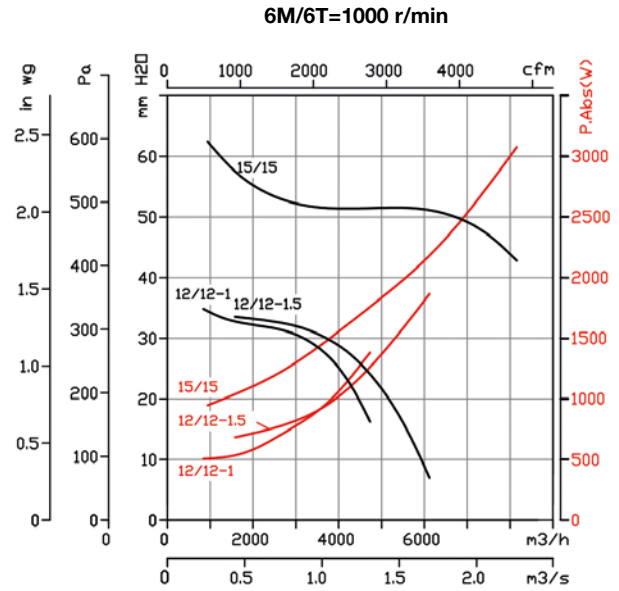
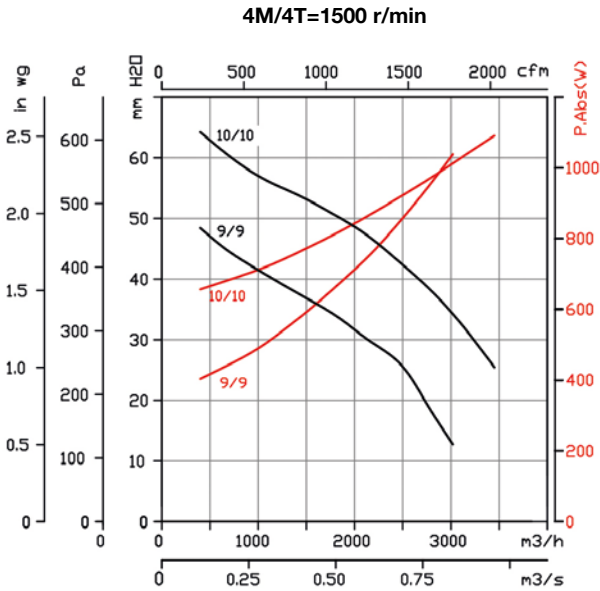

Accessories



INT



IAT



CABLE BOX



C2V



VSD3/A-RFT
- VSD1/A-RFM



CENTRAL CO



AET



P-400



VIS

CBDT

Double inlet centrifugal fans, direct drive, to work inside the fire zone 400 °C/2h and 300 °C/2h



400 °C/2h double inlet centrifugal extractor fans with direct drive motors for immersed operation in fire risk zones, with the option of a single-phase motor.

Fan:

- Galvanized steel sheet casing.
- Forward curved impeller in galvanized sheet steel.
- External terminal box.
- Approved in accordance with standard EN 12101-3, with certificate no.: 0370-CPR-0580.

Motor:

- Class H motors for S1 continuous operation and S2 emergency use. With ball bearings, IP55 protection and 1 or 2 speeds, depending on model.

- Single-phase 230 V 50 Hz and three-phase 230/400 V 50 Hz (up to 3 kW) and 400/690 V 50 Hz (powers greater than 3 kW).
- Maximum temperature of air to be carried: S1 continuous operation -20 °C +60 °C, S2 operation 300 °C/2h, 400 °C/2h.

Finish:

- Anti-corrosive in galvanized steel sheet.

On request:

- Fans with circular outlet.
- Fans with vertical outlet.

Order code

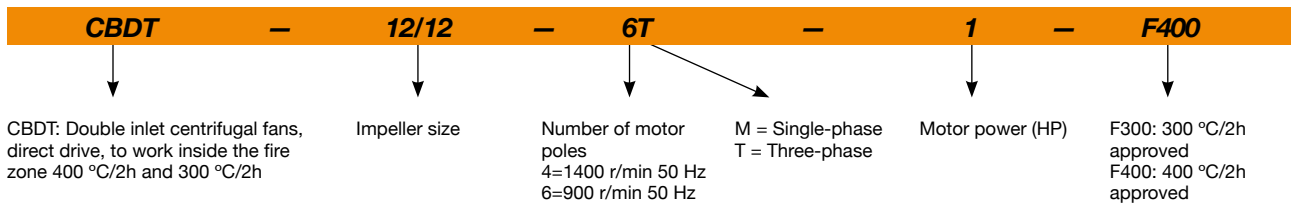

Technical characteristics

Model	Speed (r/min)	Maximum admissible current (A)			Installed power (kW)	Maximum flow rate (m³/h)	Sound pressure level ¹ dB (A)	Approx. weight (Kg)
		230V	400V	690V				
CBDT-9/9-4T	1420	2.90	1.70		0.55	3000	59	24
CBDT-9/9-4M	1410	4.10			0.55	3000	59	23
CBDT-10/10-4T	1420	2.90	1.70		0.55	3450	61	26
CBDT-10/10-4M	1410	4.10			0.55	3450	61	25
CBDT-12/12-6T-1	940	4.40	2.60		0.75	4800	58	37
CBDT-12/12-6M-1	920	5.80			0.75	4800	58	37
CBDT-12/12-6T-1.5	945	6.40	3.70		1.10	6200	60	39
CBDT-12/12-6M-1.5	920	8.40			1.10	6200	60	39
CBDT-15/15-6T	950	10.30	5.90		2.20	8250	62	68
CBDT-18/18-6T	970		11.00	6.35	4.00	11800	64	109

¹ Irradiated sound pressure level in dB(A) at a distance of 3 m.



Erp. (Energy Related Products)

Information on Directive 2009/125/EC can be downloaded from the SODECA website or the QuickFan selector programme.

Acoustic characteristics

Irradiated sound power spectrum Lw(A) in dB(A) per Hz frequency band

	63	125	250	500	1000	2000	4000	8000		63	125	250	500	1000	2000	4000	8000
CBDT-9/9-4-0.75	46	56	64	68	73	72	69	61	CBDT-12/12-6-1.5	49	60	65	72	73	73	68	62
CBDT-10/10-4-0.75	48	58	66	70	75	74	71	63	CBDT-15/15-6-3	63	72	74	76	71	70	64	55
CBDT-12/12-6-1	47	58	63	70	71	71	66	60	CBDT-18/18-6-5.5	64	74	76	78	73	72	66	57

Dimensions mm

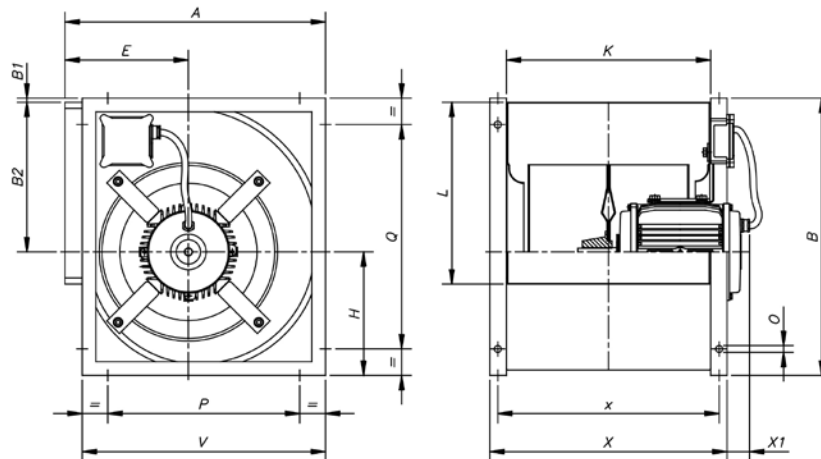

	A	B	B1	B2	E	H	K	L	P	Q	V	X	X1	x	O
CBDT-9/9	390	402	1.5	218	183	181	300	263	280	280	358	360	49	332	9x17
CBDT-10/10	430	448	2	246	202	204	326	292	326	326	398	388	33	360	9x17
CBDT-12/12	501	534	4	290	230	239.5	387	342	384	384	470	448	57	420	9x17
CBDT-15/15	584	630	-	348	265	280	473	405	460	460	550	535	58	507	9x17
CBDT-18/18	694	756	4	415	323	336	540	482	553	608	665	600	85	570	9x17

Terminal box situation

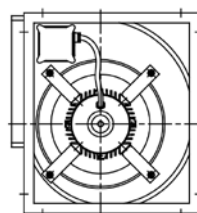

CBDT-9/9
CBDT-10/10
CBDT-12/12
CBDT-15/15

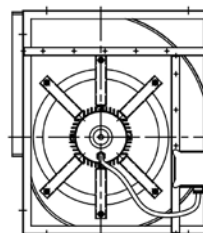

CBDT-18/18

Characteristic curves

Q= Flow rate in m³/h, m³/s and cfm

Pe= Static pressure in mm H₂O, Pa and inwg

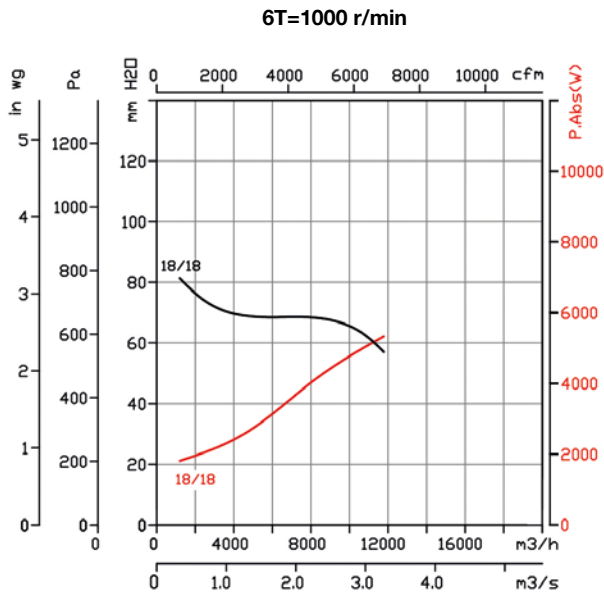
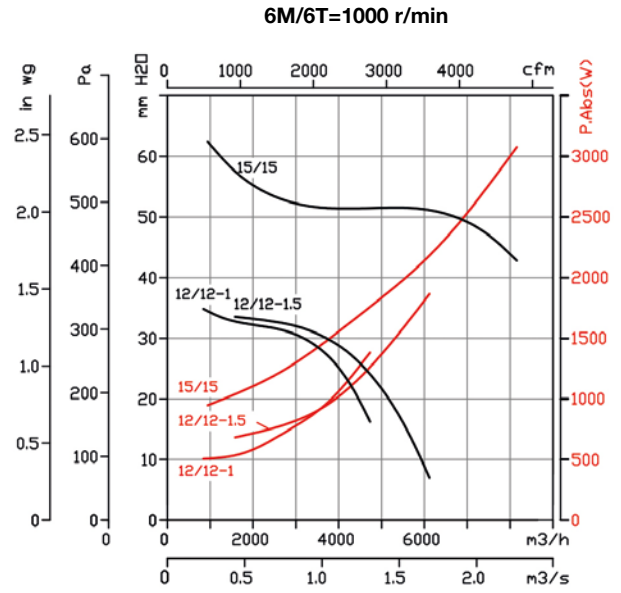
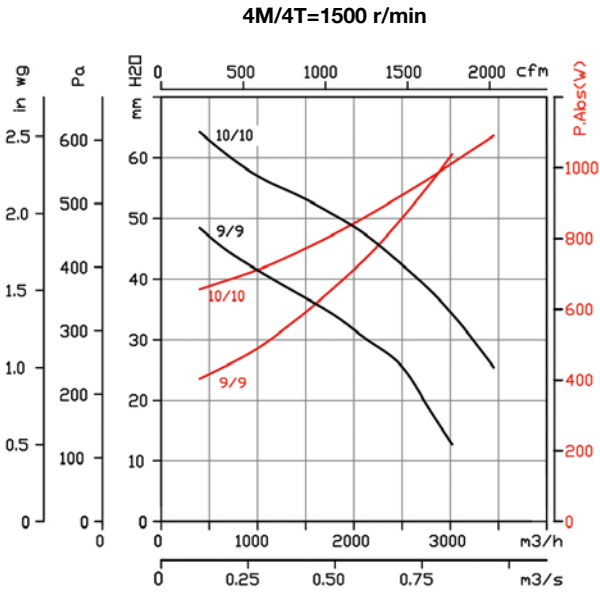

Accessories



INT



IAT



CABLE BOX



C2V



VSD3/A-RFT
- VSD1/A-RFM



CENTRAL CO



AET



P-400



VIS

CJV/EW



EC TECHNOLOGY WITH INTEGRATED VSD



Extract fans with automatic operation, vertical air outlet, EC Technology motor and constant pressure control for homes

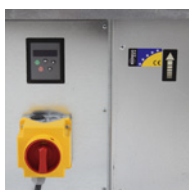

Model CJV/EW-1800/T approved for 400 °C/2h

Fan:

- Extraction units with vertical drive and two circular extraction mouths.
- Galvanized steel sheet casing.
- Forward curved impeller in galvanized sheet steel.
- Single-phase electronic speed drive (VSD), included with the fan.

Motor:

- New high-efficiency synchronous EC motors (IE4). Equipped with high intensity neodymium magnets.
- High reliability and maintenance free sensorless control.
- Fitted with long-life ball bearings.
- IP55 protection.
- Fan working temperature: -25 °C +60 °C.
- CJV/EW-1800/T: fan operating temperature: S1 -25°C +60 °C continuous operation. 400°C/2h S2 operation.
- Approved in accordance with standard EN 12101-3.

Electronic speed drive:

- Speed adjusted according to pressure setpoint.
- Automatic PI control built into the variable speed drive and differential pressure sensor.
- Drive parameters easily configurable through display and keypad.
- Supplied with safety ON/OFF switch, fully wired and ready to be installed.
- Available with single-phase input 220-240 V 50/60 Hz.
- Working temperature (VSD): -25 °C + 50 °C.

Finish:

- Anti-corrosive in galvanized steel sheet prepared to be installed outdoors.

On request:

- Fan with horizontal outlet.

Technical characteristics

Model	Speed	Single-phase VSD 230 V 50/60 Hz Maximum current input (A)	Max. electric power	Sound pressure level	Approx. weight
	min/max			min/max	
	(r/min)		(W)	Lp dB (A)	(Kg)
CJV/EW-1800	300/1800	5.2	660	21 / 60	35
CJV/EW-1800/T	300/1800	5.2	660	21 / 60	35



Erp. (Energy Related Products)

Information on Directive 2009/125/EC can be downloaded from the SODECA website or the QuickFan selector programme.

Acoustic characteristics

Sound power spectrum Lw(A) in dB(A) per Hz frequency band
Irradiated values at 1700 m³/h -250 Pa

	63	125	250	500	1000	2000	4000	8000
CJV/EW-1800	44	54	65	72	76	73	71	64
CJV/EW-1800/T	44	54	65	72	76	73	71	64

Dimensions mm

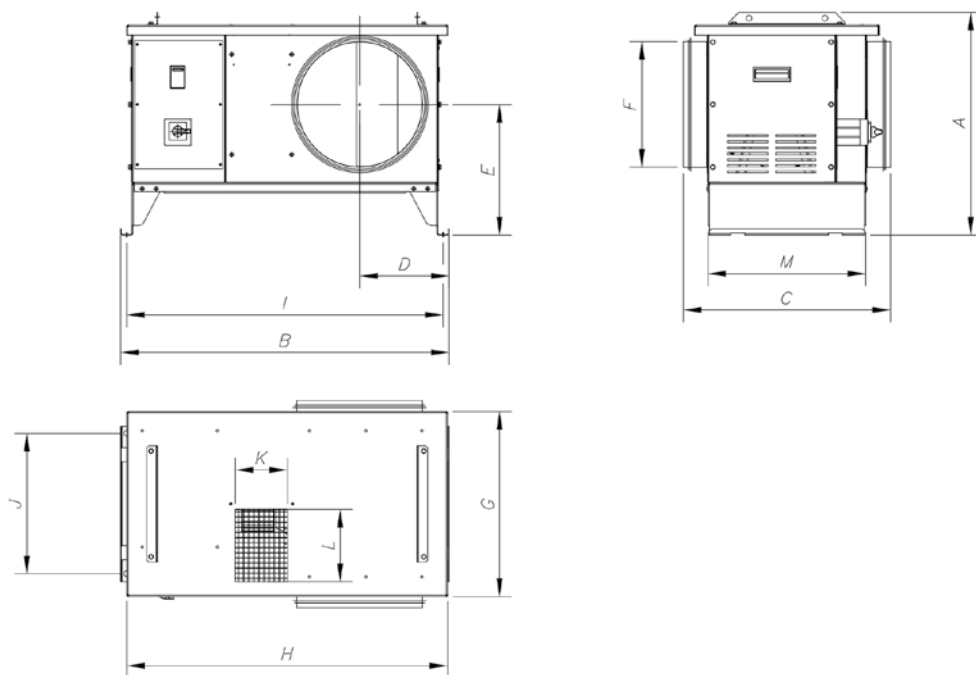

	A	B	C	D	E	F	G	H	I	J	K	L	M
CJV/EW-1800	560	815	520	225	325	315	460	800	780	345	130	180	395
CJV/EW-1800/T	560	815	520	225	325	315	460	800	780	345	130	180	395

Accessories



Characteristic curves

Flow rate in m³/h. Static pressure in Pa. Electric power in W. Irradiated sound pressure at 4 m.

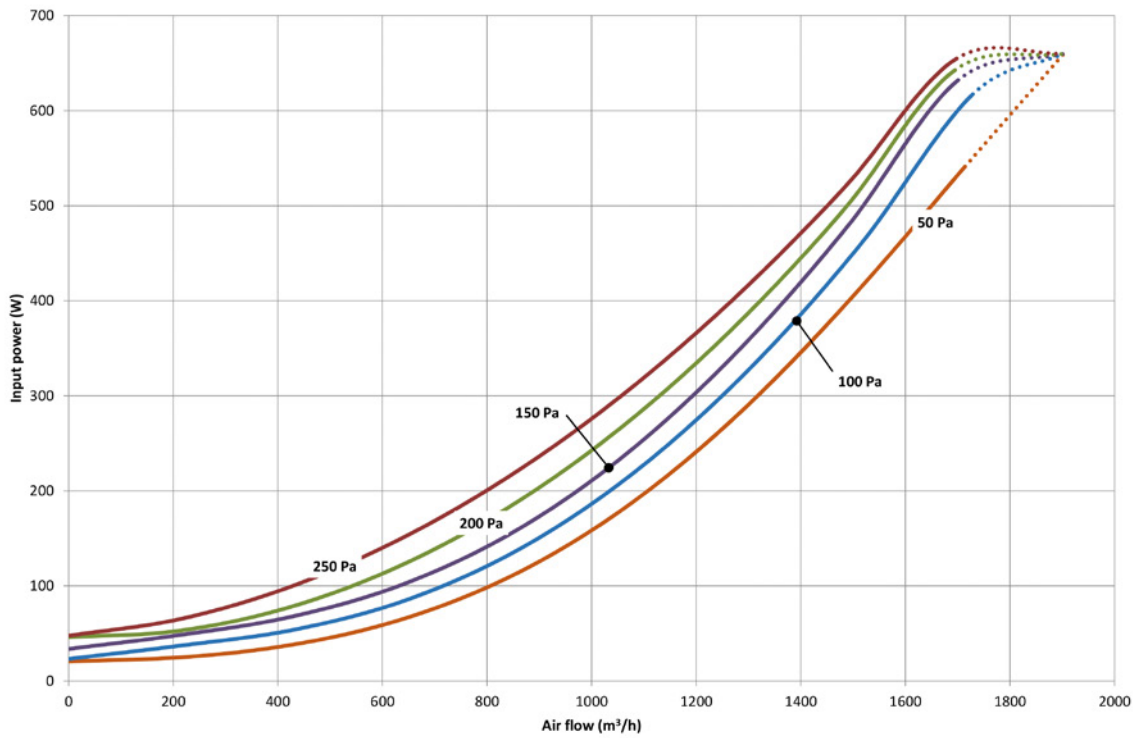
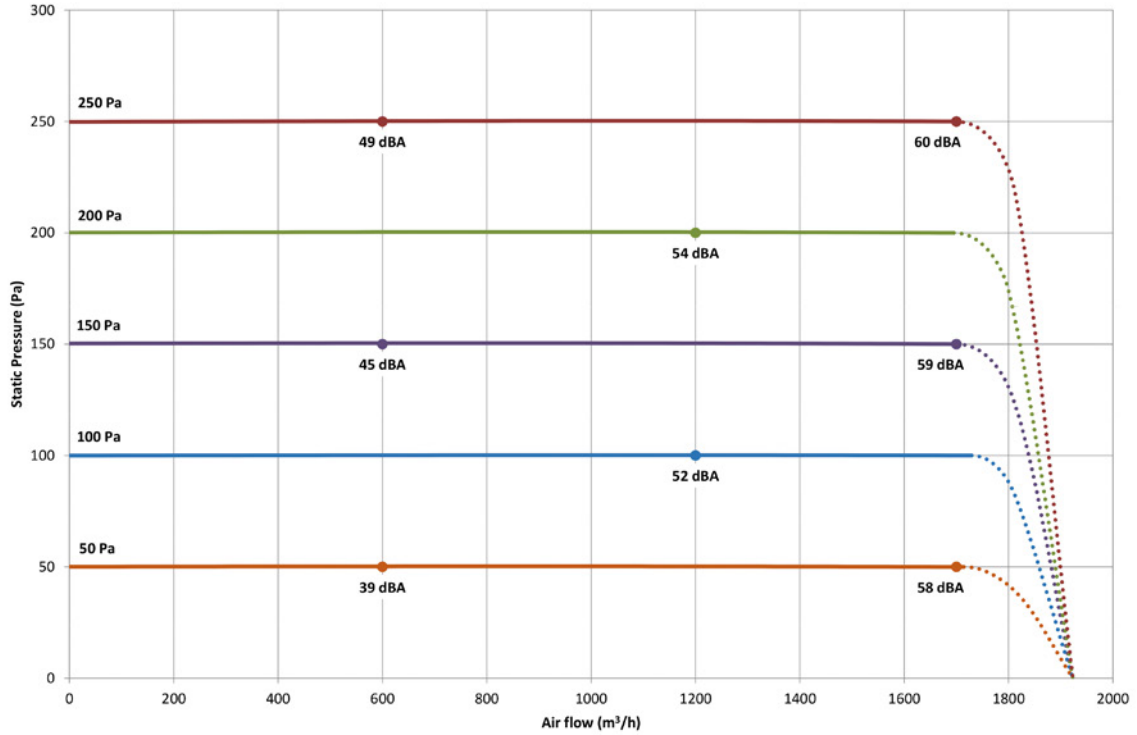

TCR

400 °C/2h and 300 °C/2h centrifugal extractor fans with backward curved impeller



Extremely robust 400 °C/2h medium pressure single inlet centrifugal extractor fans with backward curved impeller for immersed operation in fire risk zones.

Fan:

- Sheet steel casing.
- Backward curved impeller in very robust sheet steel, with anti-heat paint.
- Approved in accordance with standard EN 12101-3, with certificate no.: 0370-CPR- 0384.

Motor:

- Motors with IE3 efficiency for powers equal to or greater than 0.75 kW, except single-phase, 2-speed and 8-pole.

- Class H motors for S1 continuous operation and S2 emergency use. With ball bearings and IP55 protection.
- Three-phase 230/400 V 50 Hz (up to 3 kW) and 400/690 V 50 Hz (powers greater than 3 kW).
- Maximum temperature of air to be carried: S1 continuous operation -25 °C +120 °C. S2 operation, 300 °C/2h and 400 °C/2h.

Finish:

- Anti-corrosive finish in polyester resin, polymerised at 190 °C, after degreasing with phosphate-free nanotechnology treatment.

Order code

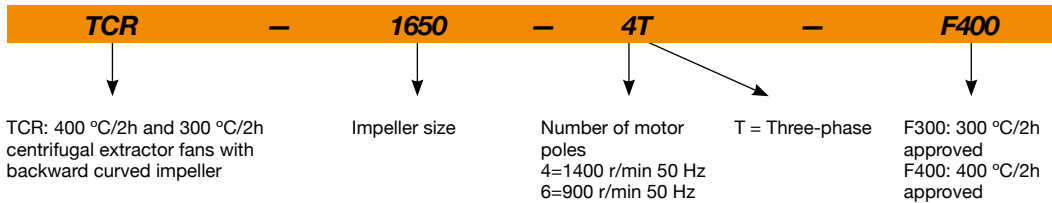

Orientations

Standard supply LG 270

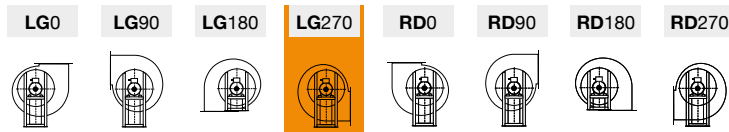

Technical characteristics

Model	Speed (r/min)	Maximum admissible current (A)			Installed power (kW)	Maximum flow rate (m³/h)	Sound pressure level¹ dB (A)	Approx. weight (Kg)
		230V	400V	690V				
TCR-1240-4T IE3	1425	3.08	1.79		0.75	5830	65	76
TCR-1445-4T IE3	1435	4.10	2.37		1.10	8100	68	98
TCR-1650-4T IE3	1140	5.89	3.38		1.50	10600	70	118
TCR-1650-6T IE3	950	3.36	1.93		0.75	7410	60	118
TCR-1856-4T IE3	1455	11.01	6.33		3.00	15240	76	158
TCR-1856-6T IE3	950	4.73	2.72		1.10	10050	68	150
TCR-2063-4T IE3	1465		10.40	6.04	5.50	24490	78	257
TCR-2063-6T IE3	955	6.25	3.62		1.50	16100	68	212
TCR-2271-4T IE3	1480		20.70	11.99	11.00	34760	84	380
TCR-2271-6T IE3	970	12.80	6.36		3.00	23010	75	313

¹ Irradiated sound pressure level in dB(A) at a distance of 3 m.

Acoustic characteristics

Irradiated sound power spectrum Lw(A) in dB(A) per Hz frequency band

	63	125	250	500	1000	2000	4000	8000		63	125	250	500	1000	2000	4000	8000
TCR-1240-4T	53	67	73	76	76	77	67	56	TCR-1856-6T	58	66	78	80	77	78	68	57
TCR-1445-4T	56	69	75	80	77	80	75	61	TCR-2063-4T	77	82	88	90	88	85	78	70
TCR-1650-4T	61	71	79	81	80	82	73	63	TCR-2063-6T	66	67	79	79	78	80	70	60
TCR-1650-6T	50	62	69	74	70	66	59	51	TCR-2271-4T	80	81	90	93	95	96	92	79
TCR-1856-4T	66	75	88	84	87	88	82	68	TCR-2271-6T	70	70	84	83	87	87	76	65

Dimensions mm

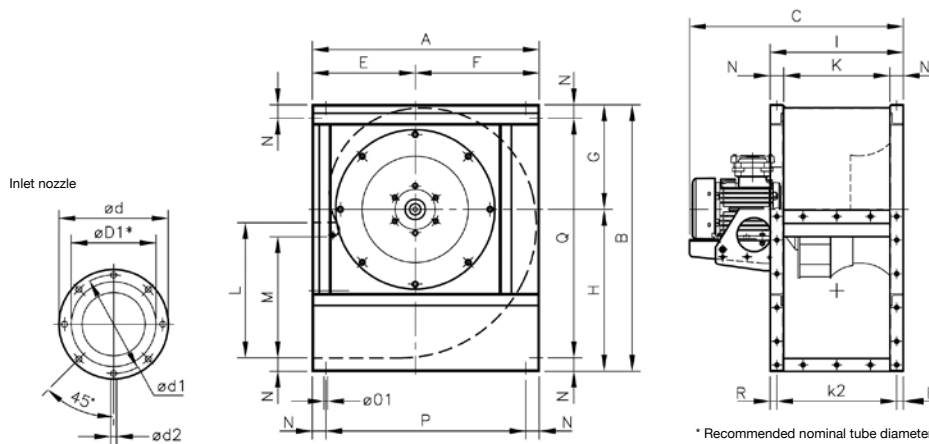

	A	B	C	Ød	Ød1	ØD1*	Ød2	E	F	G	H	M	N	Ø01	P	Q	R
TCR-1240-4T	673	790	634	472	444	400	M8	305	368	310	480	358.5	40	11	593	710	20
TCR-1445-4T	765	880	727	522	494	450	M8	350	415	339	541	407	45	11	675	790	20
TCR-1650-4T	832	970	770.5	582	555	500	M10	375	457	378	592	445	45	13	742	880	20
TCR-1650-6T	832	970	770.5	582	555	500	M10	375	457	378	592	445	45	13	742	880	20
TCR-1856-4T	925	1084	857.5	645	615	560	M10	415	510	424	660	493	50	13	825	984	25
TCR-1856-6T	925	1084	828	645	615	560	M10	415	510	424	660	493	50	13	825	984	25
TCR-2063-4T	1037	1218	955	720	688	630	M10	465	572	477	741	530	60	13	917	1098	30
TCR-2063-6T	1037	1218	932	720	688	630	M10	465	572	477	741	530	60	13	917	1098	30
TCR-2271-4T	1173	1375	1149	800	768	710	M12	525	648	538	837	603.5	65	13	1043	1245	32.5
TCR-2271-6T	1173	1375	1112	800	768	710	M12	525	648	538	837	603.5	65	13	1043	1245	32.5

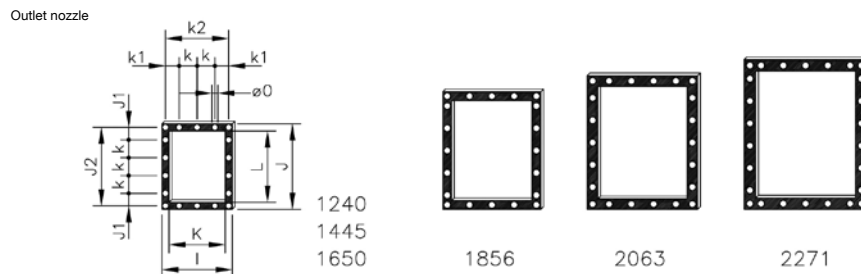

	I	J	J1	J2	K	k	k1	k2	L	Ø0
TCR-1240	395	480	70	440	315	100	77.5	355	400	11
TCR-1445	445	540	99	498	355	100	102.5	405	450	11
TCR-1650	490	590	87.5	550	400	125	100	450	500	13
TCR-1856	550	660	55	610	450	125	125	500	560	13
TCR-2063	620	750	95	690	500	125	92.5	560	630	13
TCR-2271	690	840	75	775	560	125	62.5	625	710	13

Characteristic curves

Q= Flow rate in m³/h, m³/s and cfm

Pe= Static pressure in mm H₂O, Pa and inwg

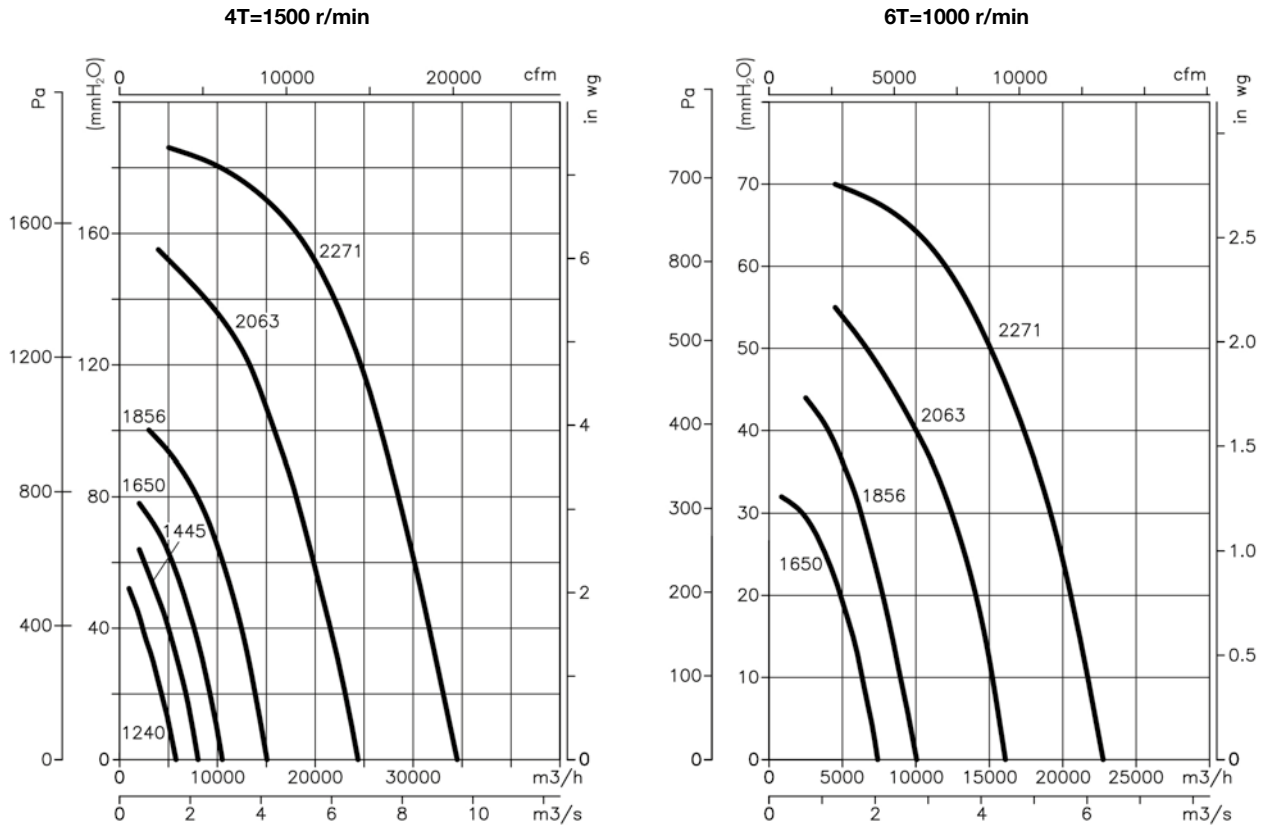

Accessories



INT



IAT



C2V



RPA



B



BD



BIC



ACE ACE/400



CABLE BOX



AET



CENTRAL CO



VSD3/A-RFT
- VSD1/A-RFM

CJS

400 °C/2h and 300 °C/2h extractor fan units with interchangeable covers



400 °C/2h extractor fan units with acoustically insulated boxes and sandwich type panel. For immersed operation in fire risk zones.

Fan:

- Galvanised sheet steel structure with thermal insulation and acoustic insulation.
- Backward curved impeller made of sheet steel.
- Interchangeable covers to supply air on either side.
- Supplied with a rectangular drive as standard, with the TAC accessory, the drive can be converted to a circular one.
- Approved in accordance with standard EN 12101-3, with certificate no.: 0370-CPR-0398.
- Linear airflow direction.

Motor:

- Class H motors for S1 continuous operation and S2 emergency use. With ball bearings, IP55 protection and 1 or 2 speeds, depending on model.
- Motors with IE3 efficiency for powers equal to or greater than 0.75 kW, except single-phase, 2-speed and 8-pole.
- Three-phase 230/400 V 50 Hz (up to 3 kW) and 400/690 V 50 Hz (powers greater than 3 kW).
- Maximum temperature of air to be carried: S1 -20 °C +40 °C continuous service, also suitable for warm climates with temperatures up to 50 °C. S2 operation, 300 °C/2h, 400 °C/2h.

Finish:

- Anti-corrosive in galvanized steel sheet.

On request:

- Fans with 2 speed motor.
- Special execution for vertical work.

Order code

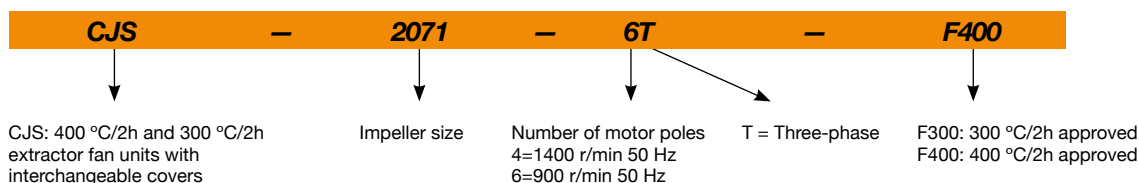

Technical characteristics

Model	Speed (r/min)	Maximum admissible current (A)			Installed power (kW)	Maximum flow rate (m ³ /h)	Sound pressure level ¹ dB (A)	Approx. weight (Kg)
		230V	400V	690V				
CJS-1850-4T IE3	1440	5.89	3.38		1.50	6670	68	87
CJS-2056-4T IE3	1465	7.86	4.52		2.20	9460	70	133
CJS-2056-6T IE3	950	3.36	1.93		0.75	6510	55	128
CJS-2071-4T IE3	1480		20.70	11.99	11.00	25000	83	285
CJS-2071-6T-3 IE3	960	9.78	5.62		2.20	12480	70	156
CJS-2071-6T-5.5 IE3	970		8.37	4.82	4.00	16020	68	251
CJS-2263-4T IE3	1465		10.40	6.04	5.50	17400	74	196
CJS-2263-6T IE3	950	4.73	2.72		1.10	8970	59	139
CJS-2880-6T IE3	970		8.37	4.82	4.00	17070	71	249

¹ Irradiated sound pressure level in dB(A) at a distance of 3 m.



Erp. (Energy Related Products)

Information on Directive 2009/125/EC can be downloaded from the SODECA website or the QuickFan selector programme.

Acoustic characteristics

Irradiated sound power spectrum Lw(A) in dB(A) per Hz frequency band

	63	125	250	500	1000	2000	4000	8000
CJS-1850-4T	66	72	77	78	81	80	73	68
CJS-2056-4T	67	73	79	79	83	83	75	68
CJS-2056-6T	52	58	64	64	68	68	60	53
CJS-2071-4T	80	81	89	92	95	96	92	78
CJS-2071-6T-3	66	65	80	79	83	83	72	61
CJS-2071-6T-5.5	65	66	74	77	80	81	77	63
CJS-2263-4T	74	79	85	87	85	82	75	67
CJS-2263-6T	59	64	70	72	70	67	60	52
CJS-2880-6T	68	74	79	80	84	83	76	69

Dimensions mm

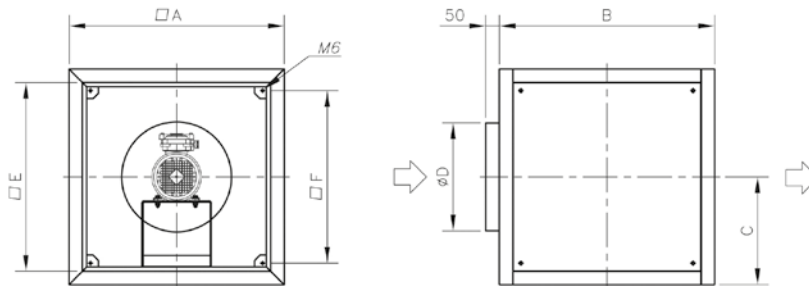

	A	B	C	D	E	F
CJS-1850-4T	800	800	400	400	700	640
CJS-2056-4T	925	925	462.5	450	825	765
CJS-2056-6T	925	925	462.5	450	825	765
CJS-2071-4T	1060	1060	530	710	960	900
CJS-2071-6T-3	1000	1000	500	630	900	840
CJS-2071-6T-5.5	1060	1060	530	710	960	900
CJS-2263-4T	1000	1000	500	630	900	840
CJS-2263-6T	925	925	462.5	560	825	765
CJS-2880-6T	1060	1060	530	710	960	900

Accessories



INT



IAT



C2V



RPA



TAC



CABLE BOX



AET



CENTRAL CO



VSD3/A-RFT
- VSD1/A-RFM

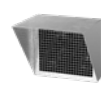

VIS

Characteristic curves

Q= Flow rate in m³/h, m³/s and cfm

Pe= Static pressure in mm H₂O, Pa and inwg

4T=1500 r/min

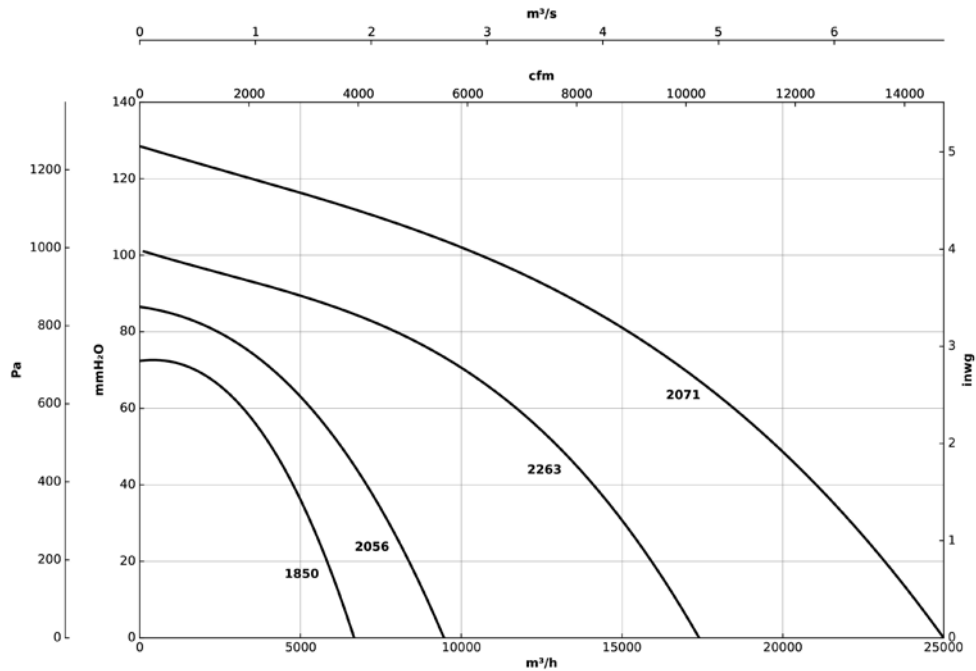

6T=1000 r/min

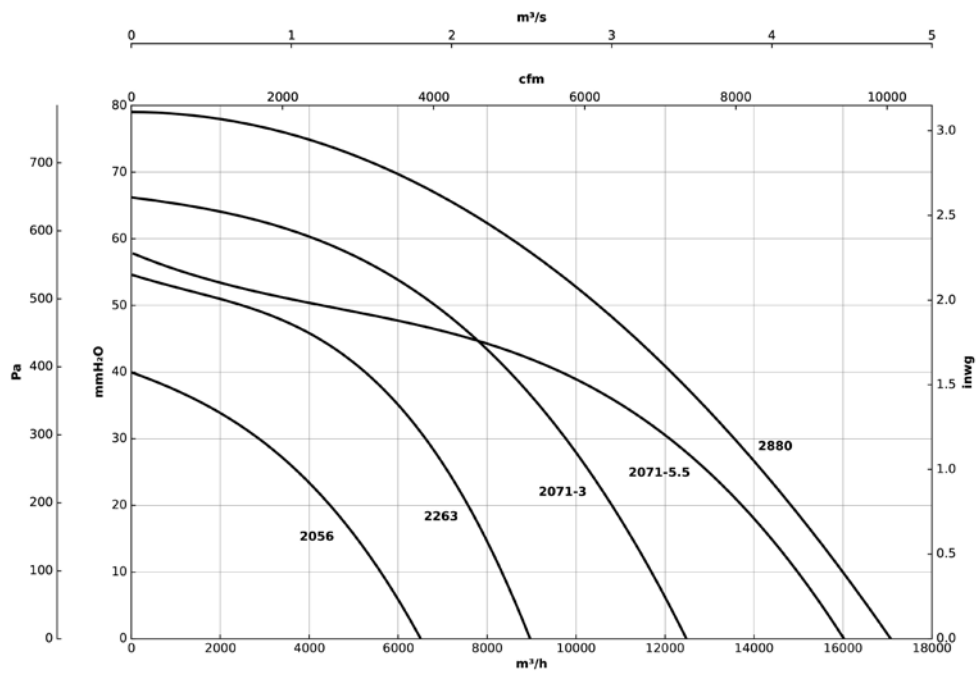

CJMD

400 °C/2h and 300 °C/2h extractor fan units with linear inlet and outlet



400 °C/2h extractor fan units with acoustically insulated boxed for immersed operation in fire risk zones.

Fan:

- Galvanised sheet steel structure with thermal insulation and acoustic insulation.
- Impeller made of sheet steel.
- Approved in accordance with standard EN 12101-3, with certificate no.: 0370-CPR-0399.
- Linear airflow direction.

Motor:

- Class H motors for S1 continuous operation and S2 emergency use. With ball bearings and IP55 protection.

- Motors with IE3 efficiency for powers equal to or greater than 0.75 kW, except single-phase, 2-speed and 8-pole.
- Three-phase 230/400 V 50 Hz (up to 3 kW) and 400/690 V 50 Hz (powers greater than 3 kW).
- Maximum temperature of air to be carried: S1 -25 °C +40 °C continuous service, also suitable for warm climates with temperatures up to 50 °C. S2 operation, 300 °C/2h, 400 °C/2h.

Finish:

- Anti-corrosive in galvanized steel sheet.

On request:

- Fans with 2 speed motor.

Order code

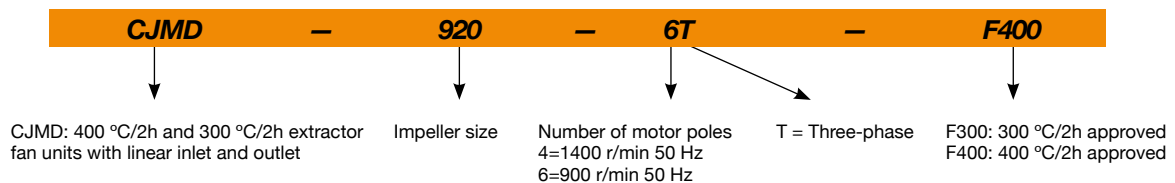

Technical characteristics

Model	Speed (r/min)	Maximum admissible current (A)			Installed power (kW)	Maximum flow rate (m³/h)	Sound pressure level ¹ dB (A)	Approx. weight (Kg)
		230V	400V	690V				
CJMD-600-4T IE3	1425	3.08	1.79		0.75	2440	51	68
CJMD-665-4T IE3	1435	4.10	2.37		1.10	3380	55	80
CJMD-730-4T IE3	1465	7.86	4.52		2.20	5000	59	100
CJMD-730-6T IE3	950	3.36	1.93		0.75	3490	45	95
CJMD-800-4T IE3	1450		7.95	4.61	4.00	6850	64	132
CJMD-800-6T IE3	955	6.25	3.62		1.50	5270	51	116
CJMD-825-6T IE3	960	9.78	5.62		2.20	7370	55	146
CJMD-885-6T IE3	960	9.78	5.62		2.20	8100	58	164
CJMD-905-4T IE3	1425	3.08	1.79		0.75	5830	59	133
CJMD-920-6T IE3	960	9.78	5.62		2.20	7270	66	184
CJMD-960-4T IE3	1435	4.10	2.37		1.10	8100	62	185
CJMD-1020-4T IE3	1440	5.89	3.38		1.50	10600	64	198
CJMD-1020-6T IE3	950	3.36	1.93		0.75	7410	54	197
CJMD-1160-6T IE3	970		8.37	4.82	4.00	11050	68	263
CJMD-1225-4T IE3	1455	11.01	6.33		3.00	15240	70	279
CJMD-1225-6T IE3	950	4.73	2.72		1.10	10050	62	274
CJMD-1330-4T IE3	1465		10.40	6.04	5.50	24490	72	409
CJMD-1330-6T IE3	955	6.25	3.62		1.50	16100	62	370
CJMD-1550-4T IE3	1480		20.70	11.99	11.00	34760	78	553
CJMD-1550-6T IE3	970	12.80	6.36		3.00	23010	69	501

¹ Irradiated sound pressure level in dB(A) at a distance of 3 m.

Acoustic characteristics

Irradiated sound power spectrum Lw(A) in dB(A) per Hz frequency band

	63	125	250	500	1000	2000	4000	8000		63	125	250	500	1000	2000	4000	8000
CJMD-600-4T	33	43	54	61	65	62	60	53	CJMD-960-4T	51	64	70	75	72	75	70	56
CJMD-665-4T	37	47	58	65	69	66	64	57	CJMD-1020-4T	56	66	74	76	75	77	68	58
CJMD-730-4T	41	51	62	69	73	70	68	61	CJMD-1020-6T	45	57	64	69	65	61	54	46
CJMD-730-6T	27	37	48	55	59	56	54	47	CJMD-1160-6T	50	60	71	78	82	80	78	70
CJMD-800-4T	47	56	67	74	78	76	74	67	CJMD-1225-4T	61	70	83	79	82	83	77	63
CJMD-800-6T	34	43	54	61	65	63	61	54	CJMD-1225-6T	53	61	73	75	72	73	63	52
CJMD-825-6T	38	47	58	65	69	67	65	58	CJMD-1330-4T	72	77	83	85	83	80	73	65
CJMD-885-6T	41	50	61	68	72	70	68	61	CJMD-1330-6T	61	62	74	74	73	75	65	55
CJMD-905-4T	48	62	68	71	71	72	62	51	CJMD-1550-4T	75	76	85	88	90	91	87	74
CJMD-920-6T	48	58	69	76	80	78	76	68	CJMD-1550-6T	65	65	79	78	82	82	71	60

Dimensions mm

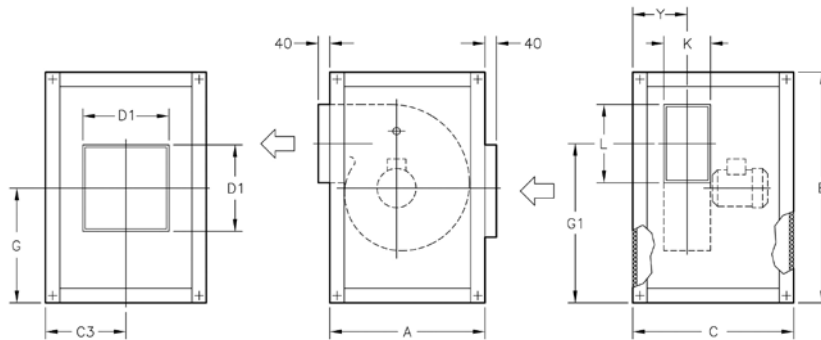

	A	B	C	C3	D1	G	G1	K	L	Y
CJMD-600-4T	735	755	604	302	400	378	500	140	215	190
CJMD-665-4T	790	810	678	339	400	405	540	165	250	215
CJMD-730-4T	855	874	748	374	400	437	577	180	295	237
CJMD-730-6T	855	874	748	374	400	437	577	180	295	237
CJMD-800-4T	941	961	798	399	500	481	653	200	320	264
CJMD-800-6T	941	961	798	399	500	481	653	200	320	264
CJMD-825-6T	1039	1059	892	446	500	530	770	230	280	296
CJMD-885-6T	1148	1168	938	469	500	585	849	250	320	330
CJMD-905-4T	970	990	896	448	500	495	636	315	400	398
CJMD-920-6T	1268	1287	954	477	600	644	945	284	360	372
CJMD-960-4T	1060	1080	966	483	600	540	694	355	450	443
CJMD-1020-4T	1150	1170	1038	519	800	585	756	400	500	490
CJMD-1020-6T	1150	1170	1038	519	800	585	756	400	500	490
CJMD-1160-6T	1375	1395	1098	549	800	698	999	315	450	414
CJMD-1225-4T	1204	1284	1258	629	800	642	836	450	560	545
CJMD-1225-6T	1204	1284	1258	629	800	642	836	450	560	545
CJMD-1330-4T	1338	1418	1474	737	800	709	921	500	630	620
CJMD-1330-6T	1338	1418	1474	737	800	709	921	500	630	620
CJMD-1550-4T	1495	1575	1648	824	1000	788	1032	560	710	675
CJMD-1550-6T	1495	1575	1648	824	1000	788	1032	560	710	675

Characteristic curves

Q= Flow rate in m³/h, m³/s and cfm

Pe= Static pressure in mm H₂O, Pa and inwg

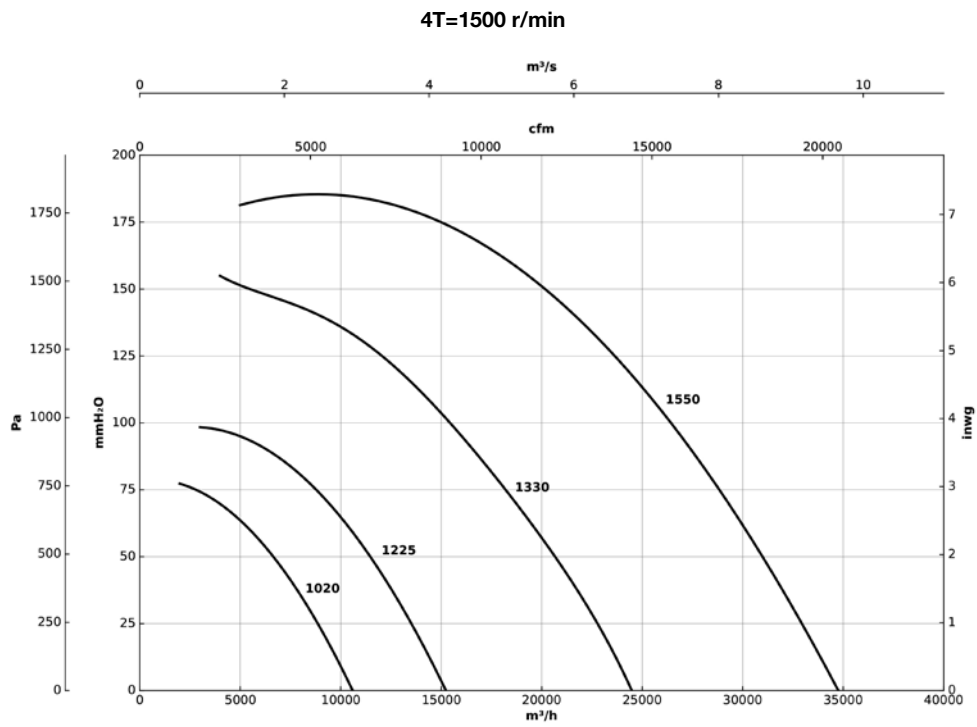
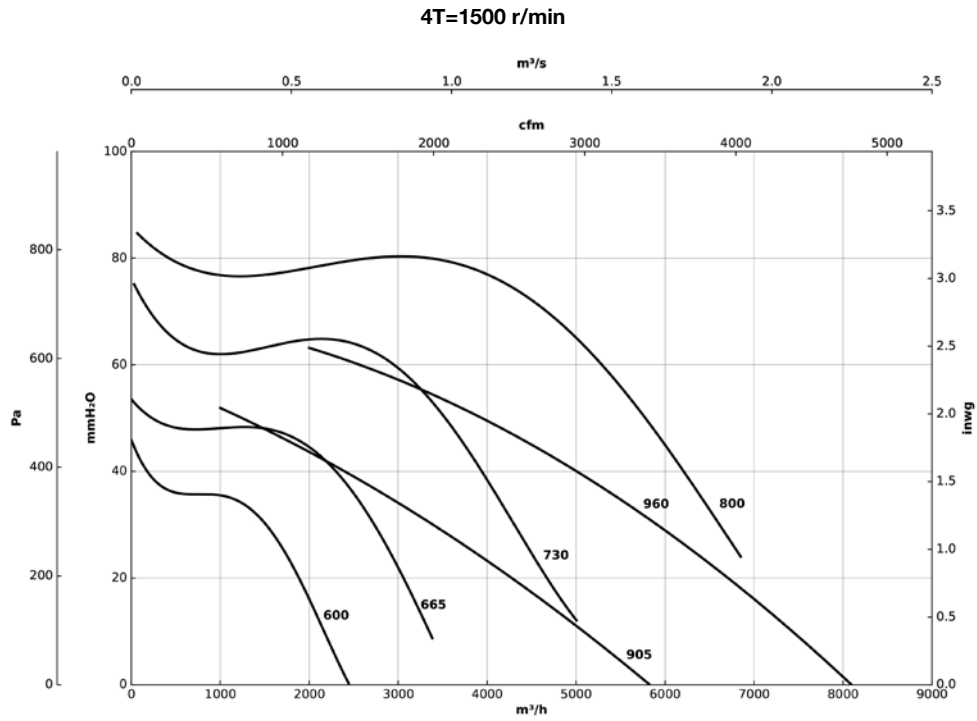

Characteristic curves

Q= Flow rate in m³/h, m³/s and cfm

Pe= Static pressure in mm H₂O, Pa and inwg

6T=1000 r/min

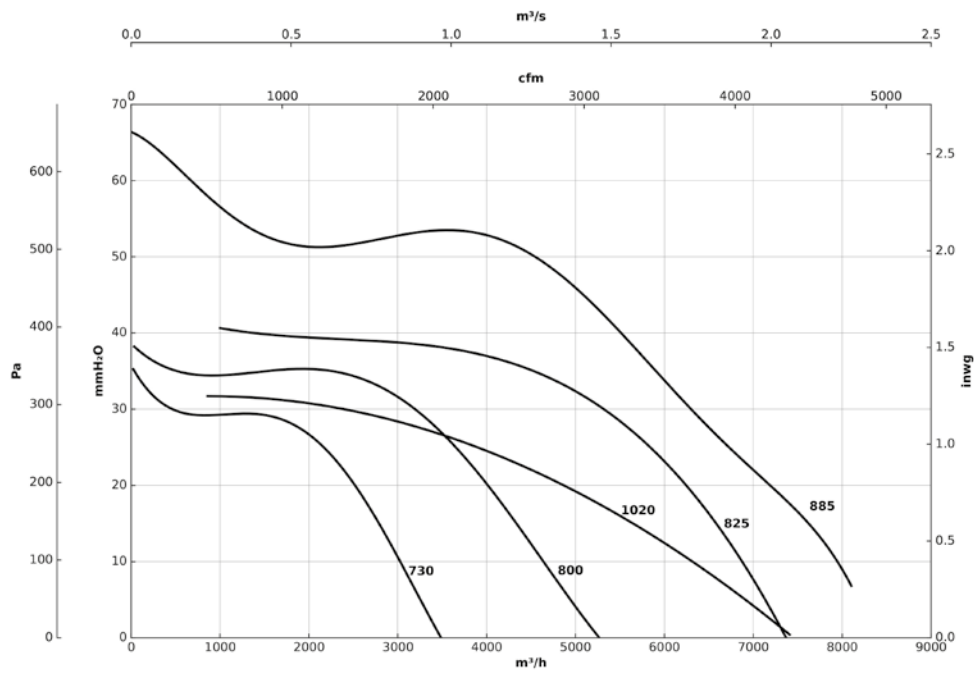

6T=1000 r/min

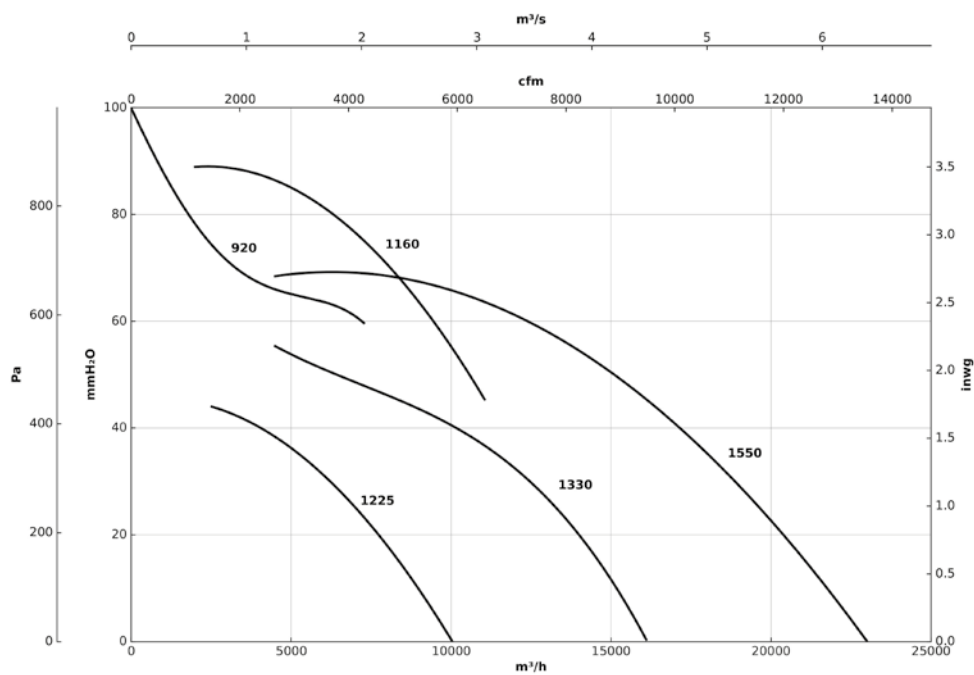

Accessories



INT



IAT



C2V



RPA



B



BD



BIC



ACE ACE/400



CABLE BOX



AET



CENTRAL CO



VSD3/A-RFT
- VSD1/A-RFM

TCR/R

400 °C/2h centrifugal extractor fans with backward curved impeller



Extremely robust, high performance backward-curved impeller

Extremely robust 400 °C/2h centrifugal, single inlet extractor fans for outdoor operation in fire risk zones and fitted with a backward curved impeller.

Fan:

- Sheet steel casing.
- Backward curved impeller in very robust sheet steel, with anti-heat paint.
- Approved in accordance with standard EN 12101-3, with certificate no.: 0370-CPR-0400.

Motor:

- Class F motors with ball bearings and IP55 protection.
- Motors with IE3 efficiency for powers equal to or greater than 0,75 kW, except single-phase, 2-speed and 8-pole.

- Three-phase 230/400 V 50 Hz (up to 4 kW) and 400/690 V 50 Hz (powers greater than 4 kW).
- Maximum temperature of air to be carried: S1 -20 °C+ 250 °C continuous service. S2 300 °C/2h and 400 °C/2h service.

Finishing:

- Anti-corrosive finish in polyester resin, polymerised at 190 °C, after degreasing with phosphate-free nanotechnology treatment.

On request:

- Fans with 2 speed motor.
- Belt-driven extractor fans.

Order code

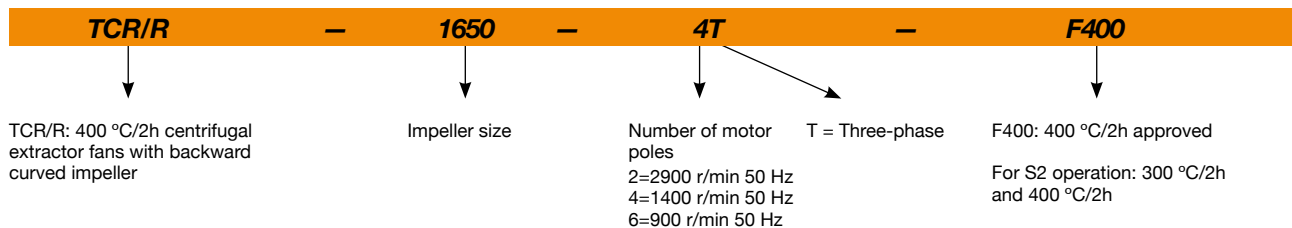

Technical characteristics

Model	Speed (r/min)	Maximum admissible current (A)			Installed power (kW)	Maximum flow rate (m³/h)	Sound pressure level dB (A)	Approx. weight (Kg)
		230V	400V	690V				
TCR/R-1240-2T IE3	2900	13.00	7.50		4.00	11110	82	102
TCR/R-1240-4T IE3	1420	2.82	1.62		0.75	5830	67	72
TCR/R-1445-2T IE3	2930		14.10	8.17	7.50	16560	85	122
TCR/R-1445-4T IE3	1455	4.07	2.34		1.10	8100	70	97
TCR/R-1650-4T IE3	1440	5.41	3.11		1.50	10600	72	122
TCR/R-1650-6T IE3	940	3.36	1.93		0.75	7450	62	114
TCR/R-1856-4T IE3	1440	10.70	6.15		3.00	15240	78	157
TCR/R-1856-6T IE3	945	4.68	2.69		1.10	10040	70	151
TCR/R-2063-4T IE3	1465		10.30	5.97	5.50	24490	80	248
TCR/R-2063-6T IE3	950	6.43	3.70		1.50	16140	70	213
TCR/R-2271-4T IE3	1470		20.90	12.10	11.00	34760	82	340
TCR/R-2271-6T IE3	970	12.00	6.91		3.00	23000	77	280



Erp. (Energy Related Products)

Information on Directive 2009/125/EC can be downloaded from the SODECA website or the QuickFan selector programme.

Acoustic characteristics

The indicated values are determined by measuring the sound pressure level and sound power in dB(A) obtained in a free field at a distance equivalent to twice the size of the fan plus the impeller diameter, with a minimum of 1.5 m.

Sound power spectrum Lw(A) in dB(A) per Hz frequency band

	63	125	250	500	1000	2000	4000	8000		63	125	250	500	1000	2000	4000	8000
TCR/R-1240-2T	68	83	81	93	90	94	96	83	TCR/R-1856-4T	69	78	91	87	90	91	85	71
TCR/R-1240-4T	56	40	76	79	79	80	70	59	TCR/R-1856-6T	61	69	81	83	80	81	71	60
TCR/R-1445-2T	73	85	83	95	93	97	99	89	TCR/R-2063-4T	80	85	91	93	91	88	81	73
TCR/R-1445-4T	59	72	78	83	80	83	78	64	TCR/R-2063-6T	69	70	82	82	81	83	73	63
TCR/R-1650-4T	64	74	82	84	83	85	76	66	TCR/R-2271-4T	79	80	89	92	94	95	91	78
TCR/R-1650-6T	53	65	72	77	73	69	62	54	TCR/R-2271-6T	73	73	87	86	90	90	79	68

Orientations

Standard supply LG 270

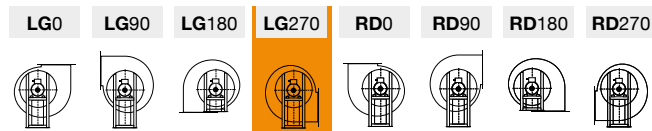

Dimensions mm

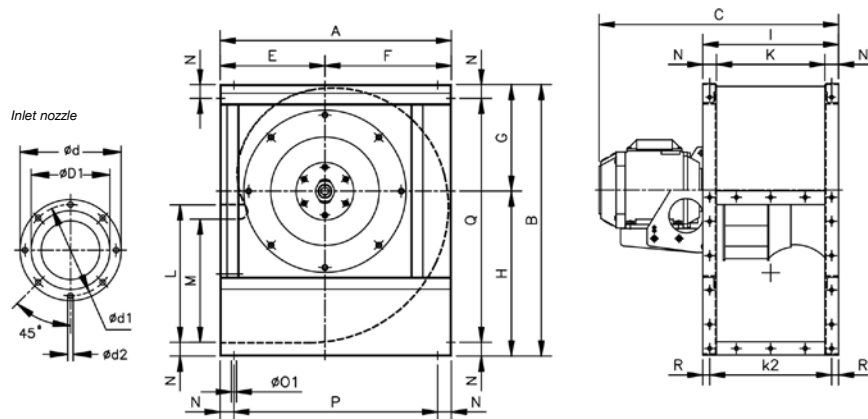

	A	B	C	Ød	Ød1	ØD1*	Ød2	E	F	G	H	M	N	Ø01	P	Q	R
TCR/R-1240-2T	673	790	734	472	444	319	M8	305	368	310	480	358.5	40	11	593	710	20
TCR/R-1240-4T	673	790	634	472	444	319	M8	305	368	310	480	358.5	40	11	593	710	20
TCR/R-1445-2T	765	880	827	524	494	358	M10	350	415	340	540	407	45	11	675	790	20
TCR/R-1445-4T	765	880	699	524	494	358	M10	350	415	340	540	407	45	11	675	790	20
TCR/R-1650-4T	832	970	953	582	555	401	M10	375	457	378	592	446	45	13	742	880	20
TCR/R-1650-6T	832	970	772.5	582	555	401	M10	375	457	378	592	446	45	13	742	880	20
TCR/R-1856-4T	925	1084	880	645	615	457	M10	415	510	426	658	493	50	13	825	984	25
TCR/R-1856-6T	925	1084	825	645	615	457	M10	415	510	426	658	493	50	13	825	984	25
TCR/R-2063-4T	1037	1218	981	720	688	507	M10	465	572	477	741	530	60	13	917	1098	30
TCR/R-2063-6T	1037	1218	932	720	688	507	M10	465	572	477	741	530	60	13	917	1098	30
TCR/R-2271-4T	1173	1375	1197	800	768	575	M10	525	648	538	837	603.5	65	13	1043	1245	32.5
TCR/R-2271-6T	1173	1375	1095	800	768	575	M10	525	648	538	837	603.5	65	13	1043	1245	32.5

* Recommended nominal tube diameter

Dimensions mm

Outlet nozzle

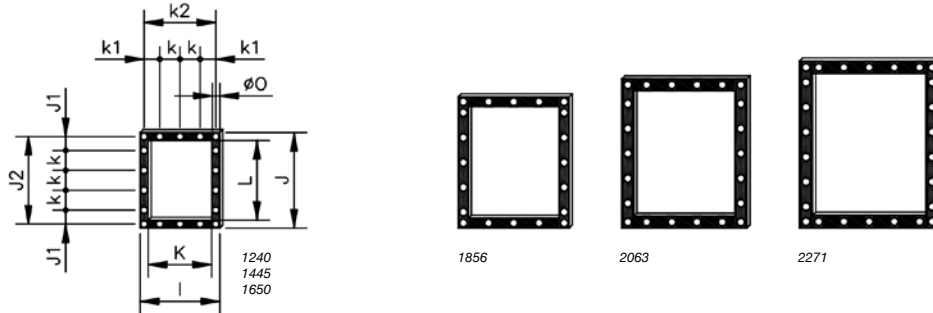

	I	J	J1	J2	K	k	k1	k2	L	Ø0
TCR/R-1240-2T	395	480	70	440	315	100	77.5	355	400	13
TCR/R-1240-4T	395	480	70	440	315	100	77.5	355	400	13
TCR/R-1445-2T	445	540	99	498	355	100	102.5	405	450	11
TCR/R-1445-4T	445	540	99	498	355	100	102.5	405	450	11
TCR/R-1650-4T	490	590	87.5	550	400	125	100	450	500	13
TCR/R-1650-6T	490	590	87.5	550	400	125	100	450	500	13
TCR/R-1856-4T	550	660	55	610	450	125	125	500	560	13
TCR/R-1856-6T	550	660	55	610	450	125	125	500	560	13
TCR/R-2063-4T	620	750	95	690	500	125	92.5	560	630	13
TCR/R-2063-6T	620	750	95	690	500	125	92.5	560	630	13
TCR/R-2271-4T	690	840	75	778	560	125	62.5	625	710	13
TCR/R-2271-6T	690	840	75	778	560	125	62.5	625	710	13

Accessories



INT



IAT



CABLE BOX



C2V



VSD3/A-RFT
- VSD1/A-RFM



CENTRAL CO



AET



RPA



B



BD



BIC



VIS



ACE ACE/400



TEJ



S

Characteristic curves

Q= Flow rate in m³/h, m³/s and cfm

Pe= Static pressure in mm H₂O, Pa and inwg

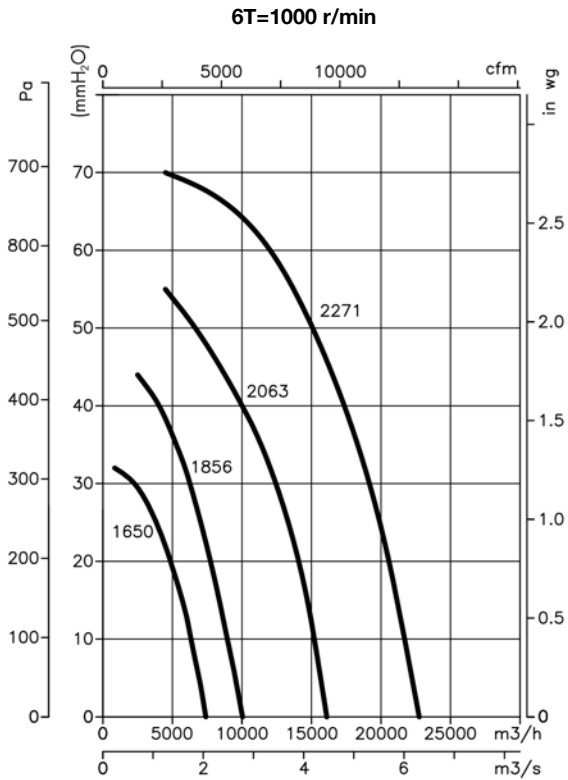
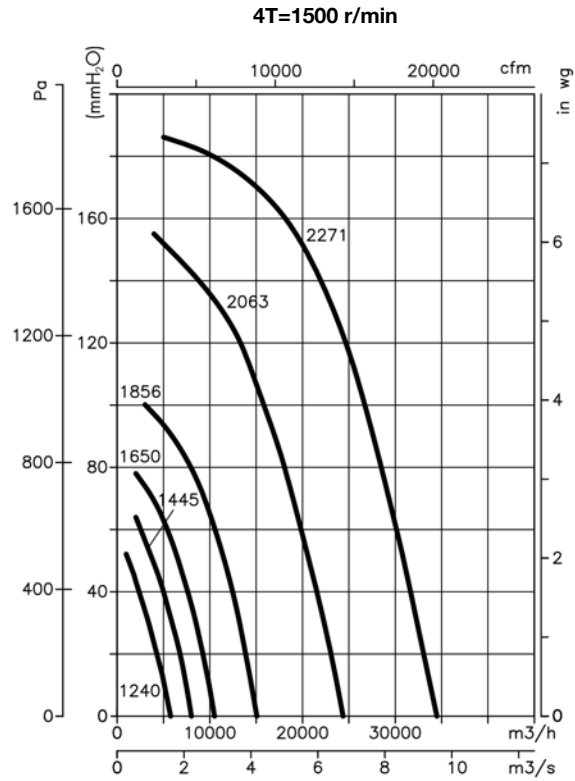
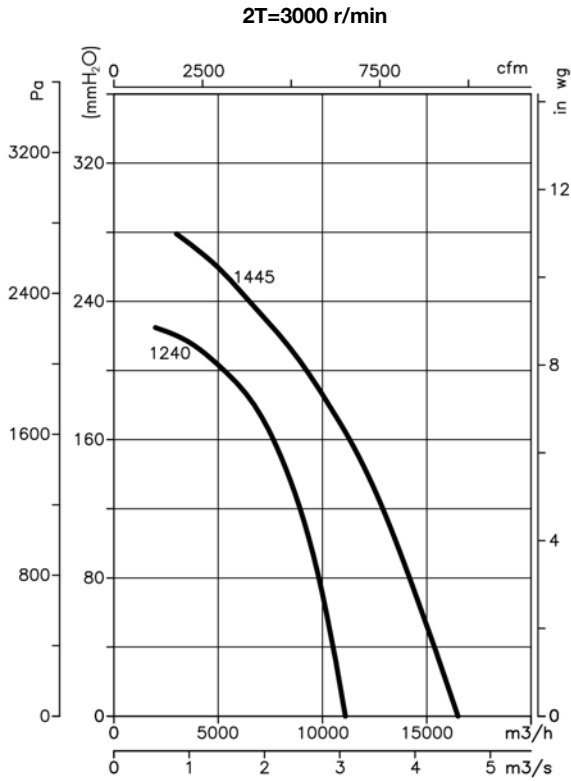

TCR/R/EW



400 °C/2h centrifugal extractor fans with backward curved impeller fitted with electronically adjustable, high efficiency, asynchronous IE3 motors



VARIABLE SPEED DRIVE
VSD: Electronic speed drive.
· VSD1/A-RFM
· VSD3/A-RFT
Supply on request

CONTROL
Supplied as an optional accessory

POWER SUPPLY
VSD1/A-RFM:
220-240 V 50/60 Hz
VSD3/A-RFT:
380-415 V 50/60 Hz

400 °C/2h centrifugal, single inlet extractor fans for outdoor operation in fire risk zones, with extreme robustness, fitted with a backward curved impeller and an electronically adjustable, high efficiency IEC asynchronous motor.

Fan:

- Sheet steel casing.
- Backward curved impeller in very robust sheet steel, with anti-heat paint.
- Approved in accordance with standard EN 12101-3.

Motor:

- New high efficiency AC asynchronous motors (IE3).
- Fitted with durable ball bearings. IP55 protection.
- Three-phase 230/400 V 50 Hz (up to 4 kW) and 400/690 V 50 Hz (powers greater than 4 kW).
- Maximum temperature of air to be carried: S1 -20 °C+ 250 °C continuous service. S2 300 °C/2h and 400 °C/2h service.

Electronic speed drive:

- Adjustable speed by 0-10 V signal or PI automatic control integrated in the inverter.

- Highly configurable electronic drive with 2 analog inputs, 2 digital inputs, 1 relay output and 1 analog or digital output to select.
- Possibility of connection to MODBUS and CAN Open field buses.
- Electronic drive for easy installation outside the work area. Thanks to its DIN rail it can be mounted on control panels minimizing connections.
- Supplied pre-wired with shielded cable in accordance with EMC directive 2014/30/EU.
- Available with single-phase 220-240 V 50/60 Hz input up to 3 CV (Type VSD1 / A-RFM) or three-phase 380-415 V 50/60 Hz (Type VSD3 / A-RFT). IP20 standard protection. IP66 protection up to 10 CV on request.
- Working temperature (VSD): -25°C + 50 °C.

Finishing:

- Anti-corrosive finish in polyester resin, polymerised at 190 °C, after degreasing with phosphate-free nanotechnology treatment.

Fan order code

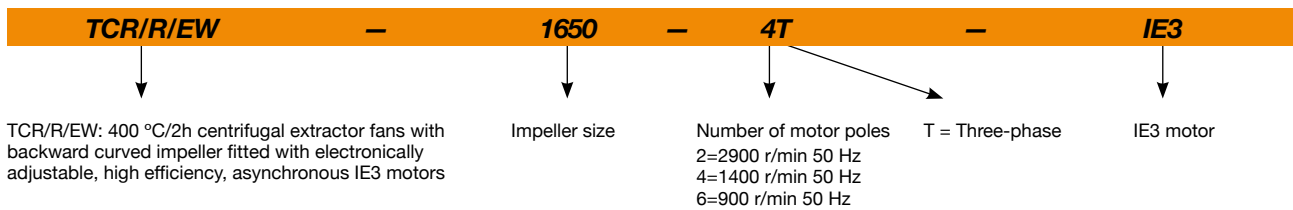

Order code with variable speed drive (VSD) included

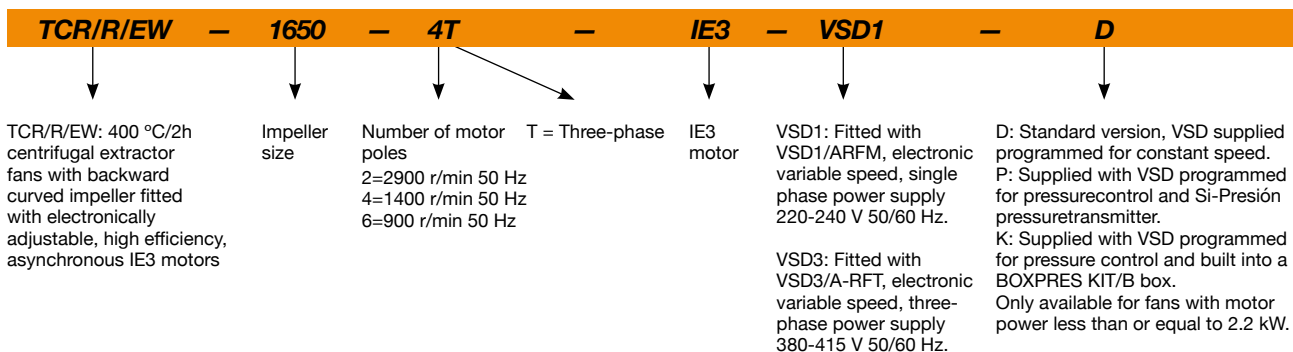

Technical characteristics

Model	Speed min/max (r/min)	Single-phase VSD 230 V 50/60 Hz		Three-phase VSD 400 V 50/60 Hz		Maximum current motor 50 Hz (A)			Installed power (kW)	Flow rate min/max (m³/h)	Sound pressure level min/max dB (A)	Approx. weight (Kg)
		Maximum current input (A)	Model VSD	Maximum current input (A)	Model VSD	230V	400V	690V				
TCR/R/EW-1240-2T-IE3	1160/2900	-	-	9.44	VSD3/A-RFT-5.5	13.00	7.50	-	4.00	4440 / 11110	62/82	93
TCR/R/EW-1240-4T-IE3	570/1420	8.32	VSD1/A-RFM-1	2.31	VSD3/A-RFT-1	2.82	1.62	-	0.75	2330 / 5830	47/67	71
TCR/R/EW-1445-2T-IE3	1170/2935	-	-	17.45	VSD3/A-RFT-10	-	13.90	8.06	7.50	6620 / 16560	65/85	126
TCR/R/EW-1445-4T-IE3	580/1455	11.87	VSD1/A-RFM-2	3.30	VSD3/A-RFT-2	4.07	2.34	-	1.10	3240 / 8100	50/70	93
TCR/R/EW-1650-4T-IE3	580/1440	15.78	VSD1/A-RFM-1	4.38	VSD3/A-RFT-2	5.41	3.11	-	1.50	4240 / 10600	52/72	114
TCR/R/EW-1650-6T-IE3	380/940	8.69	VSD1/A-RFM-1	2.41	VSD3/A-RFT-1	3.36	1.93	-	0.75	2980 / 7450	42/62	111
TCR/R/EW-1856-4T-IE3	580/1440	-	-	7.20	VSD3/A-RFT-5.5	10.70	6.15	-	3.00	6100 / 15240	58/78	152
TCR/R/EW-1856-6T-IE3	380/945	12.43	VSD1/A-RFM-2	3.45	VSD3/A-RFT-2	4.68	2.69	-	1.10	4020 / 10040	50/70	145
TCR/R/EW-2063-4T-IE3	590/1465	-	-	12.81	VSD3/A-RFT-7.5	-	10.30	5.97	5.50	9800 / 24490	60/80	225
TCR/R/EW-2063-6T-IE3	380/950	16.64	VSD1/A-RFM-2	4.62	VSD3/A-RFT-2	6.43	3.70	-	1.50	6460 / 16140	50/70	209
TCR/R/EW-2271-4T-IE3	590/1470	-	-	25.10	VSD3/A-RFT-15	-	21.40	12.40	11.00	13900 / 34760	62/82	315
TCR/R/EW-2271-6T-IE3	390/970	-	-	7.39	VSD3/A-RFT-5.5	12.00	6.91	-	3.00	9200 / 23000	57/77	280



Erp. (Energy Related Products)

Information on Directive 2009/125/EC can be downloaded from the SODECA website or the QuickFan selector programme.

Acoustic characteristics

The indicated values are determined by measuring the sound pressure level and sound power in dB(A) obtained in a free field at a distance equivalent to twice the size of the fan plus the impeller diameter, with a minimum of 1.5 m.

Sound power spectrum Lw(A) in dB(A) per Hz frequency band

	63	125	250	500	1000	2000	4000	8000		63	125	250	500	1000	2000	4000	8000
TCR/R/EW-1240-2T	68	83	81	93	90	94	96	83	TCR/R/EW-1856-4T	69	78	91	87	90	91	85	71
TCR/R/EW-1240-4T	56	40	76	79	79	80	70	59	TCR/R/EW-1856-6T	61	69	81	83	80	81	71	60
TCR/R/EW-1445-2T	73	85	83	95	93	97	99	89	TCR/R/EW-2063-4T	80	85	91	93	91	88	81	73
TCR/R/EW-1445-4T	59	72	78	83	80	83	78	64	TCR/R/EW-2063-6T	69	70	82	82	81	83	73	63
TCR/R/EW-1650-4T	64	74	82	84	83	85	76	66	TCR/R/EW-2271-4T	79	80	89	92	94	95	91	78
TCR/R/EW-1650-6T	53	65	72	77	73	69	62	54	TCR/R/EW-2271-6T	73	73	87	86	90	90	79	68

Orientations

Standard supply LG 270

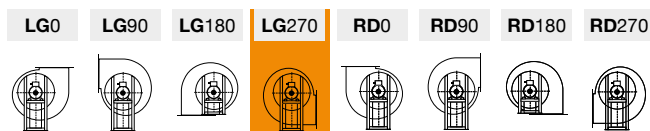

Dimensions mm

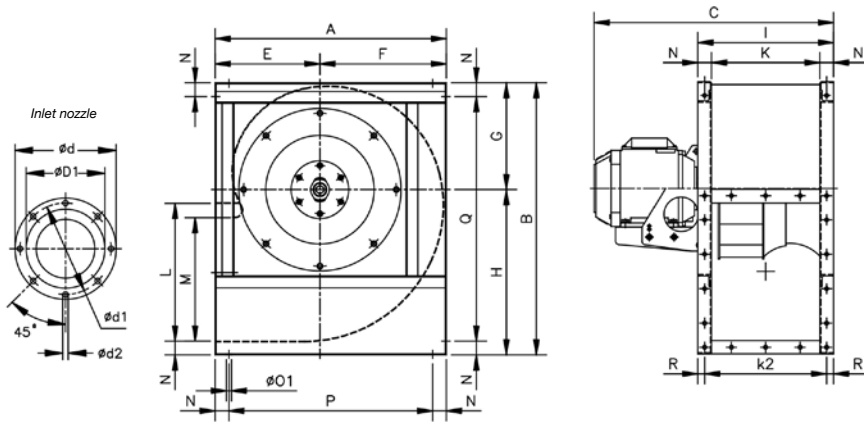

	A	B	C	Ød	Ød1	ØD1*	Ød2	E	F	G	H	I	K	k2	L	M	N	ØO1	P	Q	R
TCR/R/EW-1240-2T	673	790	734	472	444	319	M8	305	368	310	480	395	315	355	400	358.5	40	11	593	710	20
TCR/R/EW-1240-4T	673	790	634	472	444	319	M8	305	368	310	480	395	315	355	400	358.5	40	11	593	710	20
TCR/R/EW-1445-2T	765	880	827	524	494	358	M10	350	415	340	540	445	355	405	450	407	45	11	675	790	20
TCR/R/EW-1445-4T	765	880	699	524	494	358	M10	350	415	340	540	445	355	405	450	407	45	11	675	790	20
TCR/R/EW-1650-4T	832	970	953	582	555	401	M10	375	457	378	592	490	400	450	500	446	45	13	742	880	20
TCR/R/EW-1650-6T	832	970	772.5	582	555	401	M10	375	457	378	592	490	400	450	500	446	45	13	742	880	20
TCR/R/EW-1856-4T	925	1084	880	645	615	457	M10	415	510	426	658	550	450	500	560	493	50	13	825	984	25
TCR/R/EW-1856-6T	925	1084	825	645	615	457	M10	415	510	426	658	550	450	500	560	493	50	13	825	984	25
TCR/R/EW-2063-4T	1037	1218	981	720	688	507	M10	465	572	477	741	620	500	560	630	530	60	13	917	1098	30
TCR/R/EW-2063-6T	1037	1218	932	720	688	507	M10	465	572	477	741	620	500	560	630	530	60	13	917	1098	30
TCR/R/EW-2271-4T	1173	1375	1197	800	768	575	M10	525	648	538	837	690	560	625	710	603.5	65	13	1043	1245	32.5
TCR/R/EW-2271-6T	1173	1375	1095	800	768	575	M10	525	648	538	837	690	560	625	710	603.5	65	13	1043	1245	32.5

* Recommended nominal tube diameter

Outlet nozzle

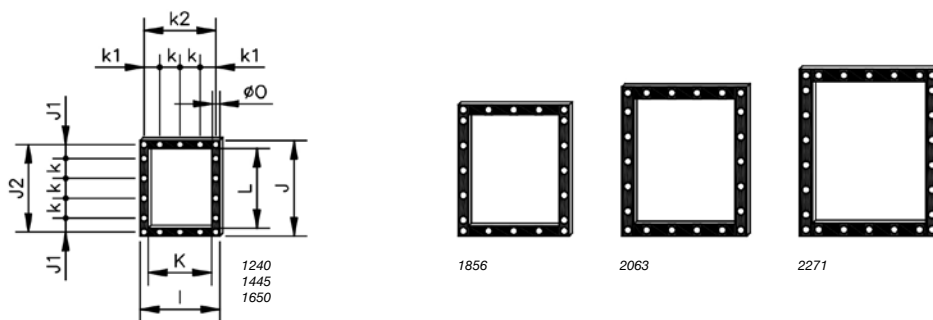

	I	J	J1	J2	K	k3	k1	k2	L	Ø0
TCR/R/EW-1240	395	480	70	440	315	100	77.5	355	400	13
TCR/R/EW-1445	445	540	99	498	355	100	102.5	405	450	11
TCR/R/EW-1650	490	590	87.5	550	400	125	100	450	500	13
TCR/R/EW-1856	550	660	55	610	450	125	125	500	560	13
TCR/R/EW-2063	620	750	95	690	500	125	92.5	560	630	13
TCR/R/EW-2271	690	840	75	778	560	125	62.5	625	710	13

Characteristic curves

Q= Flow rate in m³/h, m³/s and cfm

Pe= Static pressure in mm H₂O, Pa and inwg

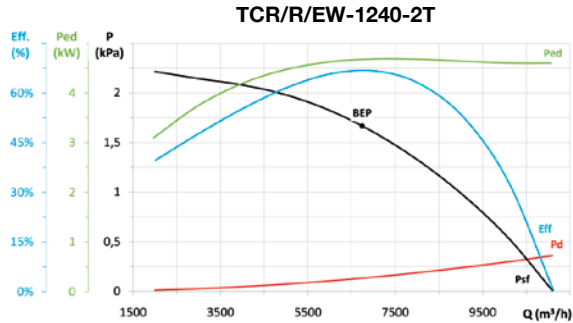

MC	EC	SR	Cc	η_e (%)*	N	[kW]	[m ³ /h]	[Pa]	[rpm]	VSD
A	S	1,02	1,04	69,6%	73,1	4,675	6744	1667,2	2901	NECESSARY

* η_e (%) = Eff. (%) x Cc

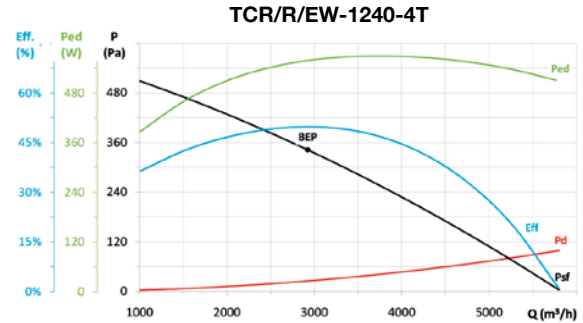

MC	EC	SR	Cc	η_e (%)*	N	[kW]	[m ³ /h]	[Pa]	[rpm]	VSD
A	S	1,00	1,11	55,1%	68,2	0,558	2924	342,3	1453	NECESSARY

* η_e (%) = Eff. (%) x Cc

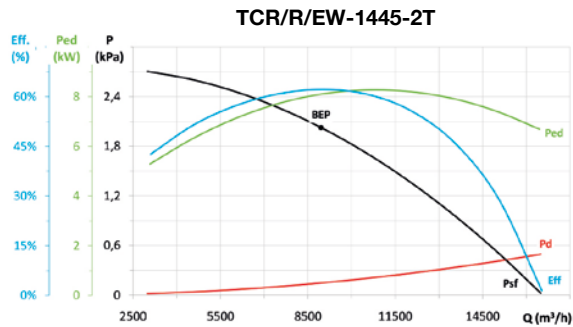

MC	EC	SR	Cc	η_e (%)*	N	[kW]	[m ³ /h]	[Pa]	[rpm]	VSD
A	S	1,02	1,04	64,6%	65,6	8,103	8951	2025,7	2939	NECESSARY

* η_e (%) = Eff. (%) x Cc

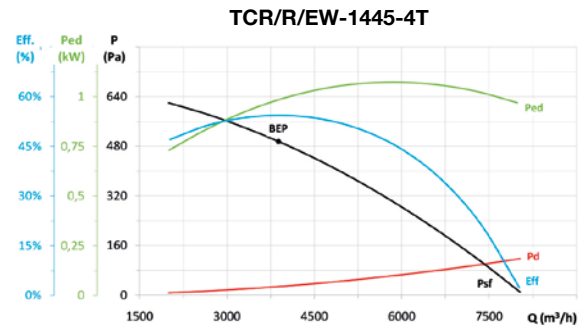

MC	EC	SR	Cc	η_e (%)*	N	[kW]	[m ³ /h]	[Pa]	[rpm]	VSD
A	S	1,01	1,09	59,1%	69,7	0,983	3883	495,3	1468	NECESSARY

* η_e (%) = Eff. (%) x Cc

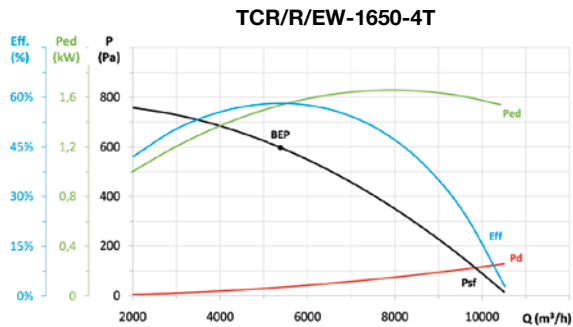

MC	EC	SR	Cc	η_e (%)*	N	[kW]	[m ³ /h]	[Pa]	[rpm]	VSD
A	S	1,01	1,08	62,5%	71,1	1,535	5378	597,4	1449	NECESSARY

* η_e (%) = Eff. (%) x Cc

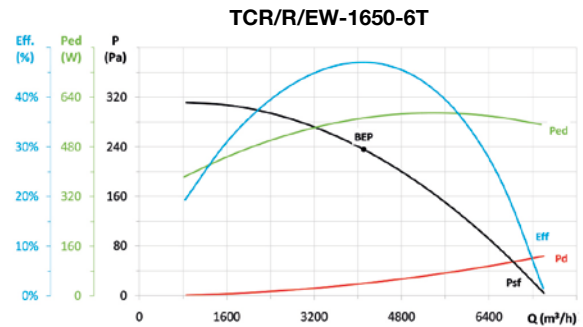

MC	EC	SR	Cc	η_e (%)*	N	[kW]	[m ³ /h]	[Pa]	[rpm]	VSD
A	S	1,00	1,10	52,0%	65,0	0,572	4109	235,7	966	NECESSARY

* η_e (%) = Eff. (%) x Cc

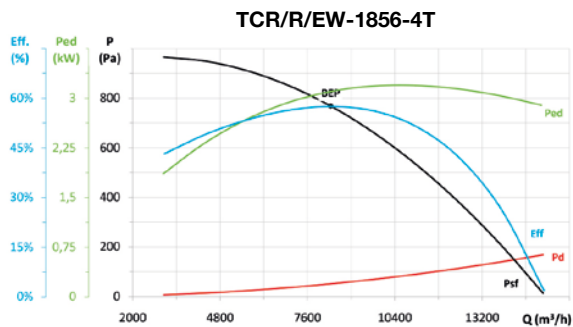

MC	EC	SR	Cc	η_e (%)*	N	[kW]	[m ³ /h]	[Pa]	[rpm]	VSD
A	S	1,01	1,05	60,6%	65,9	3,096	8342	768,0	1448	NECESSARY

* η_e (%) = Eff. (%) x Cc

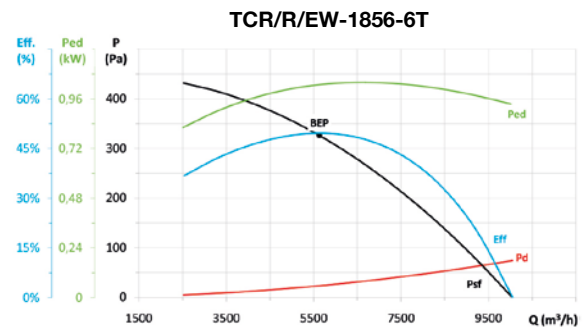

MC	EC	SR	Cc	η_e (%)*	N	[kW]	[m ³ /h]	[Pa]	[rpm]	VSD
A	S	1,00	1,09	53,9%	64,3	1,028	5632	326,1	960	NECESSARY

* η_e (%) = Eff. (%) x Cc

Characteristic curves

Q= Flow rate in m³/h, m³/s and cfm

Pe= Static pressure in mm H₂O, Pa and inwg

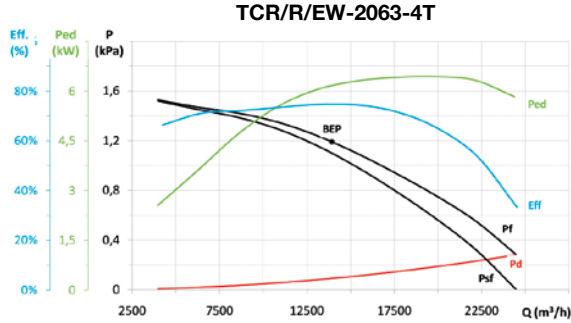

MC	EC	SR	Cc	η_e (%)*	N	[kW]	[m ³ /h]	[Pa]	[rpm]	VSD
B	T	1,01	1,04	77,8%	80,0	6,161	13932	1190,7	1466	NECESSARY

* η_e (%) = Eff. (%) x Cc

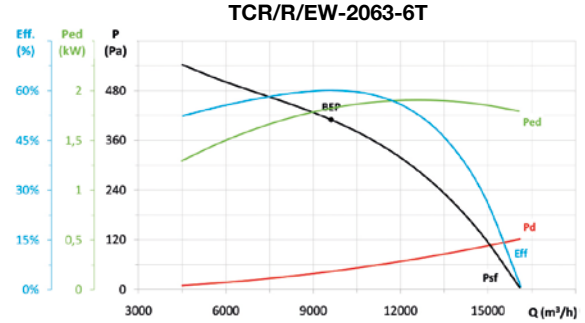

MC	EC	SR	Cc	η_e (%)*	N	[kW]	[m ³ /h]	[Pa]	[rpm]	VSD
A	S	1,00	1,07	64,3%	72,1	1,822	9620	409,7	952	NECESSARY

* η_e (%) = Eff. (%) x Cc

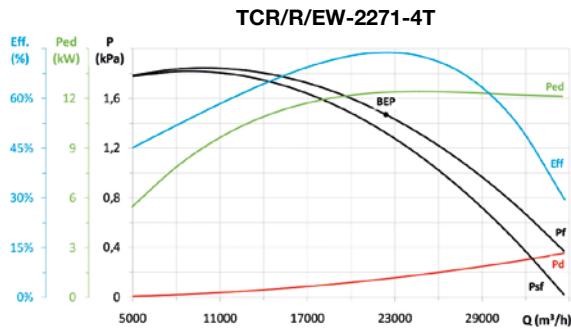

MC	EC	SR	Cc	η_e (%)*	N	[kW]	[m ³ /h]	[Pa]	[rpm]	VSD
B	T	1,01	1,04	76,8%	76,7	12,369	22380	1469,6	1470	NECESSARY

* η_e (%) = Eff. (%) x Cc

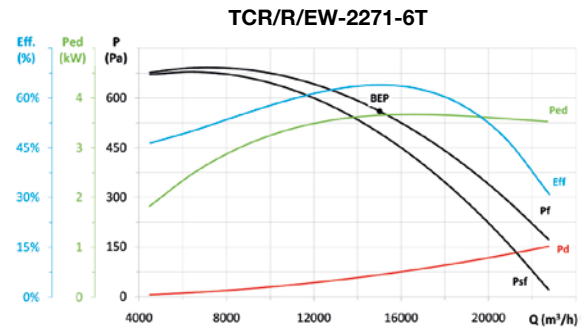

MC	EC	SR	Cc	η_e (%)*	N	[kW]	[m ³ /h]	[Pa]	[rpm]	VSD
B	T	1,01	1,05	67,1%	71,7	3,654	15016	560,2	970	NECESSARY

* η_e (%) = Eff. (%) x Cc

Accessories



CJTCR/R

400 °C/2h extractor fan units with backward curved impeller



Extremely robust, high performance backward-curved impeller

Extremely robust 400 °C/2h single inlet extractor fan units with acoustically insulated box, for outdoor operation in fire risk zones.

Fan:

- Sheet steel casing.
- Backward curved impeller in very robust sheet steel, with anti-heat paint.
- Approved in accordance with standard EN 12101-3, with certificate no.: 0370-CPR-0401.

Motor:

- Class F motors with ball bearings and IP55 protection.
- Motors with IE3 efficiency for powers equal to or greater than 0,75 kW, except single-phase, 2-speed and 8-pole.

- Three-phase 230/400 V 50 Hz (up to 4 kW) and 400/690 V 50 Hz (powers greater than 4 kW).
- Maximum temperature of air to be carried: S1 -20 °C+ 250 °C continuous service. S2 300 °C/2h and 400 °C/2h service.

Finishing:

- Anti-corrosive in galvanized steel sheet.

On request:

- Fans with 2 speed motor.
- Belt-driven extractor fans.

Order code

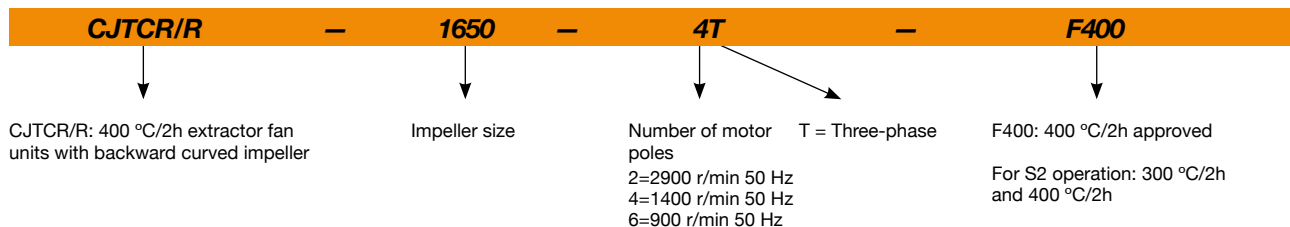

Technical characteristics

Model	Speed (r/min)	Maximum admissible current (A)			Installed power (kW)	Maximum flow rate (m³/h)	Sound pressure level dB (A)	Approx. weight (Kg)
		230V	400V	690V				
CJTCR/R-1240-2T IE3	2900	13.00	7.50		4.00	11110	77	156
CJTCR/R-1240-4T IE3	1420	2.82	1.62		0.75	5830	62	126
CJTCR/R-1445-2T IE3	2930		14.10	8.17	7.50	16560	80	206
CJTCR/R-1445-4T IE3	1455	4.07	2.34		1.10	8100	65	181
CJTCR/R-1650-4T IE3	1440	5.41	3.11		1.50	10600	66	197
CJTCR/R-1650-6T IE3	940	3.36	1.93		0.75	7450	57	189
CJTCR/R-1856-4T IE3	1440	10.70	6.15		3.00	15240	73	278
CJTCR/R-1856-6T IE3	945	4.68	2.69		1.10	10040	65	272
CJTCR/R-2063-4T IE3	1465		10.30	5.97	5.50	24490	75	403
CJTCR/R-2063-6T IE3	950	6.43	3.70		1.50	16140	65	368
CJTCR/R-2271-4T IE3	1470		20.90	12.10	11.00	34760	82	533
CJTCR/R-2271-6T IE3	970	12.00	6.91		3.00	23000	72	473



Erp. (Energy Related Products)

Information on Directive 2009/125/EC can be downloaded from the SODECA website or the QuickFan selector programme.

Acoustic characteristics

The indicated values are determined by measuring the sound pressure level and sound power in dB(A) obtained in a free field at a distance equivalent to twice the size of the fan plus the impeller diameter, with a minimum of 1.5 m.

Sound power spectrum Lw(A) in dB(A) per Hz frequency band

	63	125	250	500	1000	2000	4000	8000		63	125	250	500	1000	2000	4000	8000
CJTCR/R-1240-2T	63	78	76	88	85	89	91	78	CJTCR/R-1856-4T	64	73	86	82	85	86	80	66
CJTCR/R-1240-4T	51	65	71	74	74	75	65	54	CJTCR/R-1856-6T	56	64	76	78	75	76	66	55
CJTCR/R-1445-2T	68	80	78	90	88	92	94	84	CJTCR/R-2063-4T	75	80	86	88	86	83	76	68
CJTCR/R-1445-4T	54	67	73	78	75	78	73	59	CJTCR/R-2063-6T	64	65	77	77	76	78	68	58
CJTCR/R-1650-4T	58	68	76	78	77	79	70	60	CJTCR/R-2271-4T	79	80	89	92	94	95	91	78
CJTCR/R-1650-6T	48	60	67	72	68	64	57	49	CJTCR/R-2271-6T	68	68	82	81	85	85	74	63

Orientations

Standard supply LG 270

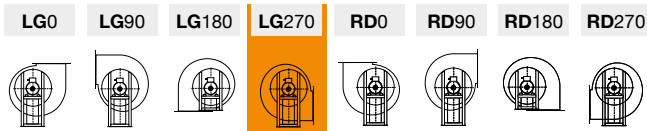

Dimensions mm

Standard supply: LG 270

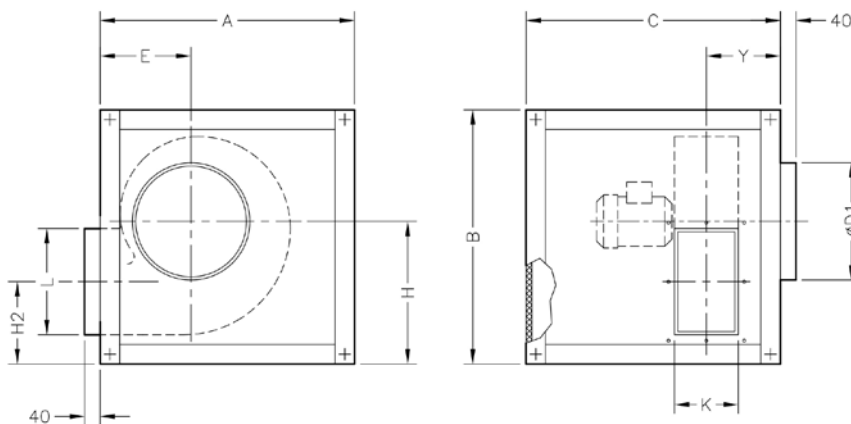

	A	B	C	ØD1	E	H	H2	K	L	Y
CJTCR/R-1240	970	970	970	400	312	549	308	315	400	307.5
CJTCR/R-1445	1070	1070	1070	450	357	610	339	355	450	333.5
CJTCR/R-1650	1160	1160	1160	500	382	660	365	400	500	355
CJTCR/R-1856	1260	1260	1050	560	422	727	399	450	560	360
CJTCR/R-2063	1400	1400	1200	630	472	810	444	500	630	395
CJTCR/R-2271	1555	1555	1355	710	532	906	489	560	715	430

Dimensions mm

Supply on request: LG 90

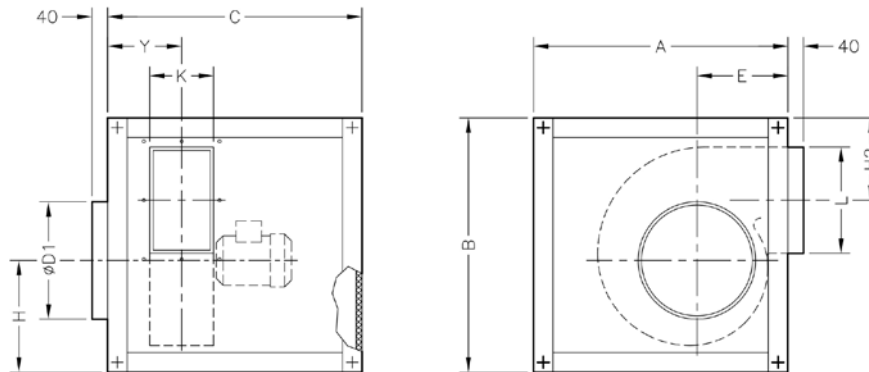

	A	B	C	ØD1	E	H	H2	K	L	Y
CJTCR/R-1240	970	970	970	400	312	379	350	315	400	307.5
CJTCR/R-1445	1070	1070	1070	450	357	408	391	355	450	333.5
CJTCR/R-1650	1160	1160	1160	500	382	447	419	400	500	355
CJTCR/R-1856	1260	1260	1050	560	422	495	438	450	560	360
CJTCR/R-2063	1400	1400	1200	630	472	546	488	500	630	395
CJTCR/R-2271	1555	1555	1355	710	532	607	532	560	715	430

Supply on request: LG 0

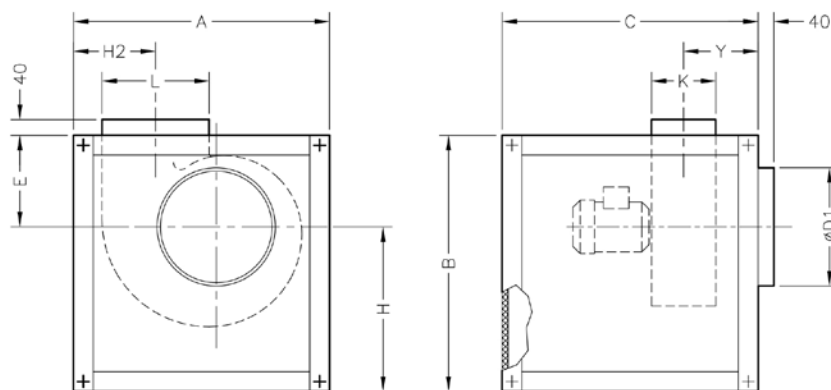

	A	B	C	ØD1	E	H	H2	K	L	Y
CJTCR/R-1240	970	970	970	400	533	437	322	315	400	307.5
CJTCR/R-1445	1070	1070	1070	450	586	484	367	355	450	333.5
CJTCR/R-1650	1160	1160	1160	500	634.5	525.5	391.5	400	500	355
CJTCR/R-1856	1260	1260	1050	560	681.5	578.5	442.5	450	560	360
CJTCR/R-2063	1400	1400	1200	630	759	641	482	500	630	395
CJTCR/R-2271	1555	1555	1355	710	838	717	518.5	560	715	430

Dimensions mm

Outlet nozzle

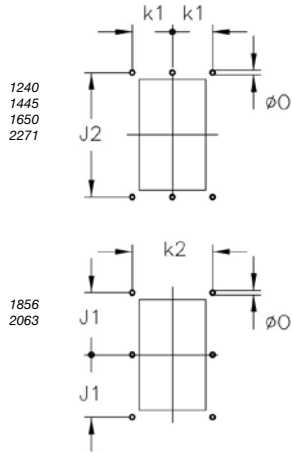

	k1	k2	J1	J2	Ø0
CJTCR/R-1240	177.5	-	-	440	11
CJTCR/R-1445	202.5	-	-	498	11
CJTCR/R-1650	225	-	-	550	13
CJTCR/R-1856	-	500	305	-	13
CJTCR/R-2063	-	560	345	-	13
CJTCR/R-2271	312.5	-	-	775	13

Accessories



INT



IAT



CABLE BOX



C2V



VSD3/A-RFT
- VSD1/A-RFM



CENTRAL CO



AET



RPA



B



BD



BIC



VIS



ACE ACE/400



TEJ

Characteristic curves

Q= Flow rate in m³/h, m³/s and cfm

Pe= Static pressure in mm H₂O, Pa and in wg

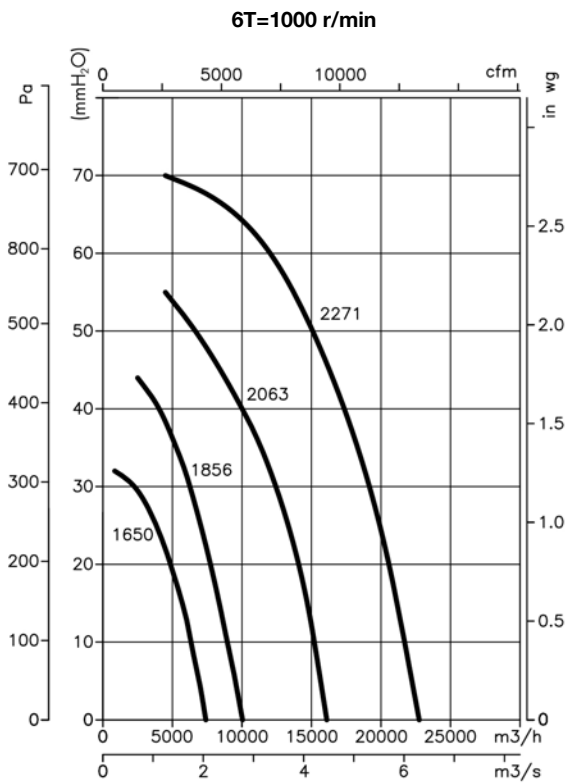
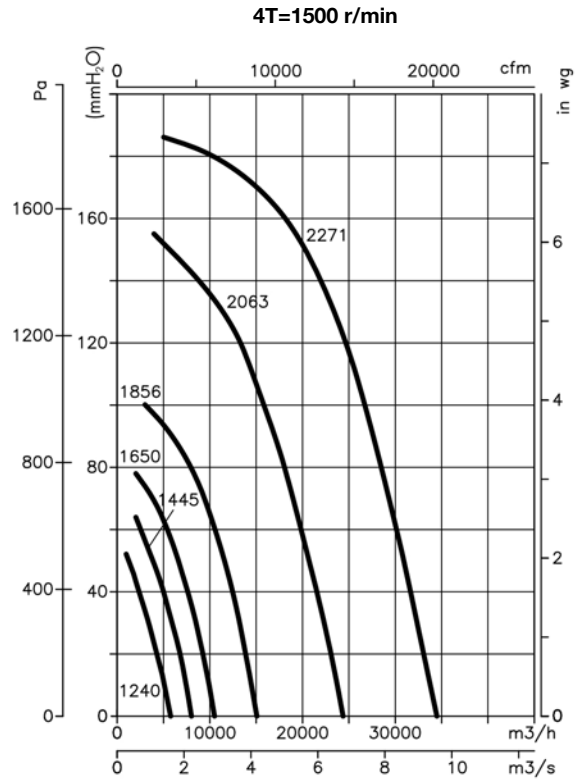
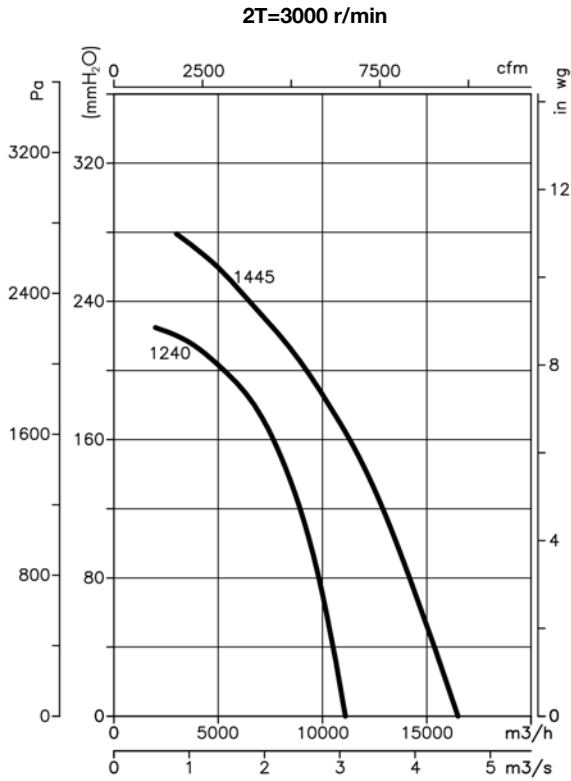

CJTCR/R/EW



400 °C/2h extraction units fans with backward curved impeller fitted with electronically adjustable, high-efficiency, asynchronous IE3 motors



VARIABLE SPEED DRIVE
VSD: Electronic speed drive.
· VSD1/A-RFM
· VSD3/A-RFT
Supply on request

CONTROL
Supplied as an optional accessory

POWER SUPPLY
VSD1/A-RFM:
220-240 V 50/60 Hz
VSD3/A-RFT:
380-415 V 50/60 Hz

Extremely robust 400 °C/2h single inlet extractor fan units with acoustically insulated box, for outdoor operation in fire risk zones. Fitted with electronically adjustable and high efficiency asynchronous IE3 motors.

Fan:

- Sheet steel casing.
- Backward curved impeller in very robust sheet steel, with anti-heat paint.
- Approved in accordance with standard EN 12101-3.

Motor:

- New high efficiency AC asynchronous motors (IE3).
- Fitted with durable ball bearings. IP55 protection.
- Three-phase 230/400 V 50 Hz (up to 4 kW) and 400/690 V 50 Hz (powers greater than 4 kW).
- Maximum temperature of air to be carried: S1 -20 °C+ 250 °C continuous service. S2 300 °C/2h and 400 °C/2h service.

Electronic speed drive:

- Adjustable speed by 0-10 V signal or PI automatic control integrated in the inverter.
- Highly configurable electronic drive with 2 analog inputs, 2 digital inputs, 1 relay output and 1 analog or digital output to select.
- Possibility of connection to MODBUS and CAN Open field buses.
- Electronic drive for easy installation outside the work area. Thanks to its DIN rail it can be mounted on control panels minimizing connections.
- Supplied pre-wired with shielded cable in accordance with EMC directive 2014/30/EU.
- Available with single-phase 220-240 V 50/60 Hz input up to 3 CV (Type VSD1 / A-RFM) or three-phase 380-415 V 50/60 Hz (Type VSD3 / A-RFT). IP20 standard protection. IP66 protection up to 10 CV on request.
- Working temperature (VSD): -25°C + 50 °C.

Finishing:

- Anti-corrosive in galvanized steel sheet.

Fan order code

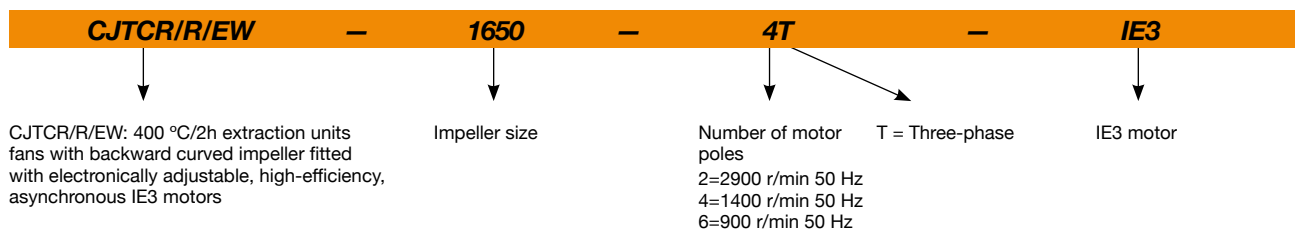

Order code with variable speed drive (VSD) included

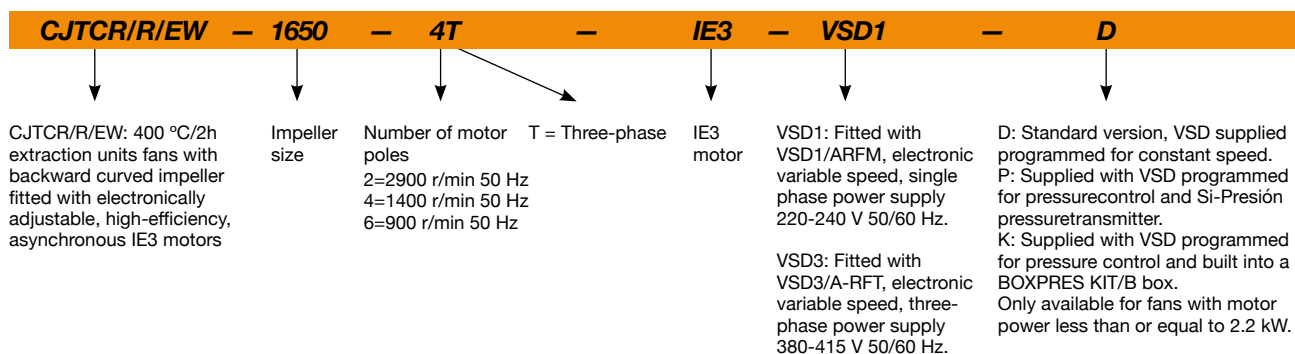

Technical characteristics

Model	Speed min/max (r/min)	Single-phase VSD 230 V 50/60 Hz		Three-phase VSD 400 V 50/60 Hz		Maximum current motor 50 Hz (A)			Installed power (kW)	Flow rate min/max (m ³ /h)	Sound pressure level min/max dB (A)	Approx. weight (Kg)
		Maximum current input (A)	Model VSD	Maximum current input (A)	Model VSD	230V	400V	690V				
CJTCR/R/EW-1240-2T-IE3	1160/2900	-	-	9.44	VSD3/A-RFT-5.5	13.00	7.50	-	4.00	4440 / 11110	57/77	147
CJTCR/R/EW-1240-4T-IE3	570/1420	8.32	VSD1/A-RFM-1	2.31	VSD3/A-RFT-1	2.82	1.62	-	0.75	2330 / 5830	42/62	125
CJTCR/R/EW-1445-2T-IE3	1170/2935	-	-	17.45	VSD3/A-RFT-10	-	13.90	8.06	7.50	6620 / 16560	60/80	210
CJTCR/R/EW-1445-4T-IE3	580/1455	11.87	VSD1/A-RFM-2	3.30	VSD3/A-RFT-2	4.07	2.34	-	1.10	3240 / 8100	45/65	177
CJTCR/R/EW-1650-4T-IE3	580/1440	15.78	VSD1/A-RFM-2	4.38	VSD3/A-RFT-2	5.41	3.11	-	1.50	4240 / 10600	46/66	189
CJTCR/R/EW-1650-6T-IE3	380/940	8.69	VSD1/A-RFM-1	2.41	VSD3/A-RFT-1	3.36	1.93	-	0.75	2980 / 7450	37/57	186
CJTCR/R/EW-1856-4T-IE3	580/1440	-	-	7.20	VSD3/A-RFT-5.5	10.70	6.15	-	3.00	6100 / 15240	53/73	273
CJTCR/R/EW-1856-6T-IE3	380/945	12.43	VSD1/A-RFM-2	3.45	VSD3/A-RFT-2	4.68	2.69	-	1.10	4020 / 10040	45/65	266
CJTCR/R/EW-2063-4T-IE3	590/1465	-	-	12.81	VSD3/A-RFT-7.5	-	10.30	5.97	5.50	9800 / 24490	55/75	380
CJTCR/R/EW-2063-6T-IE3	380/950	16.64	VSD1/A-RFM-2	4.62	VSD3/A-RFT-2	6.43	3.70	-	1.50	6460 / 16140	45/65	364
CJTCR/R/EW-2271-4T-IE3	590/1470	-	-	25.10	VSD3/A-RFT-15	-	21.40	12.40	11.00	13900 / 34760	62/82	508
CJTCR/R/EW-2271-6T-IE3	390/970	-	-	7.39	VSD3/A-RFT-5.5	12.00	6.91	-	3.00	9200 / 23000	52/72	473



Erp. (Energy Related Products)

Information on Directive 2009/125/EC can be downloaded from the SODECA website or the QuickFan selector programme.

Acoustic characteristics

The indicated values are determined by measuring the sound pressure level and sound power in dB(A) obtained in a free field at a distance equivalent to twice the size of the fan plus the impeller diameter, with a minimum of 1.5 m.

Sound power spectrum Lw(A) in dB(A) per Hz frequency band

	63	125	250	500	1000	2000	4000	8000		63	125	250	500	1000	2000	4000	8000
CJTCR/R/EW-1240-2T	63	78	76	88	85	89	91	78	CJTCR/R/EW-1856-4T	64	73	86	82	85	86	80	66
CJTCR/R/EW-1240-4T	51	65	71	74	74	75	65	54	CJTCR/R/EW-1856-6T	56	64	76	78	75	76	66	55
CJTCR/R/EW-1445-2T	68	80	78	90	88	92	94	84	CJTCR/R/EW-2063-4T	75	80	86	88	86	83	76	68
CJTCR/R/EW-1445-4T	54	67	73	78	75	78	73	59	CJTCR/R/EW-2063-6T	64	65	77	77	76	78	68	58
CJTCR/R/EW-1650-4T	58	68	76	78	77	79	70	60	CJTCR/R/EW-2271-4T	79	80	89	92	94	95	91	78
CJTCR/R/EW-1650-6T	48	60	67	72	68	64	57	49	CJTCR/R/EW-2271-6T	68	68	82	81	85	85	74	63

Orientations

Standard supply LG 270

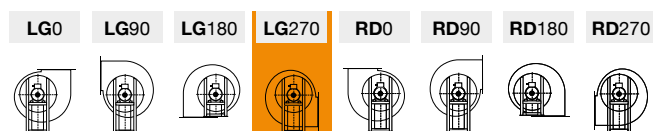

Dimensions mm

Standard supply: LG 270

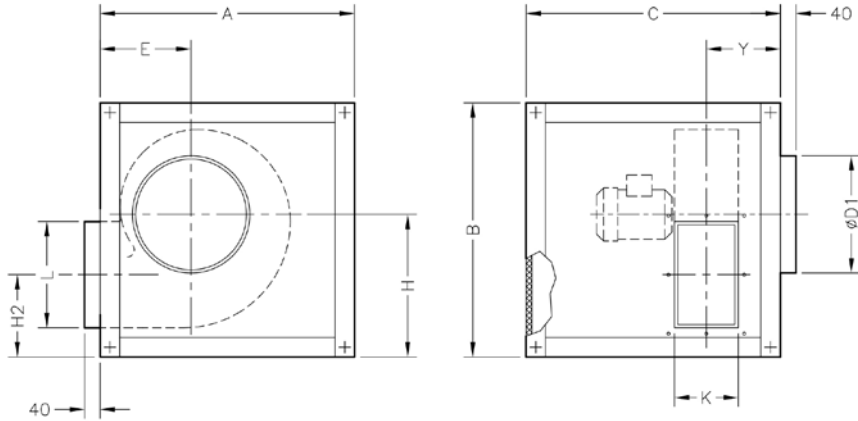

	A	B	C	ØD1	E	H	H2	K	L	Y
CJTCR/R/EW-1240	970	970	970	400	312	549	308	315	400	307.5
CJTCR/R/EW-1445	1070	1070	1070	450	357	610	339	355	450	333.5
CJTCR/R/EW-1650	1160	1160	1160	500	382	660	365	400	500	355
CJTCR/R/EW-1856	1260	1260	1050	560	422	727	399	450	560	360
CJTCR/R/EW-2063	1400	1400	1200	630	472	810	444	500	630	395
CJTCR/R/EW-2271	1555	1555	1355	710	532	906	489	560	715	430

Supply on request: LG 90

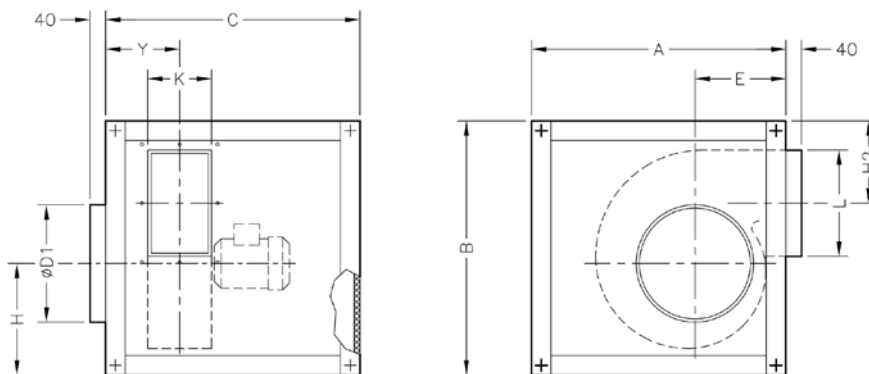

	A	B	C	ØD1	E	H	H2	K	L	Y
CJTCR/R/EW-1240	970	970	970	400	312	379	350	315	400	307.5
CJTCR/R/EW-1445	1070	1070	1070	450	357	408	391	355	450	333.5
CJTCR/R/EW-1650	1160	1160	1160	500	382	447	419	400	500	355
CJTCR/R/EW-1856	1260	1260	1050	560	422	495	438	450	560	360
CJTCR/R/EW-2063	1400	1400	1200	630	472	546	488	500	630	395
CJTCR/R/EW-2271	1555	1555	1355	710	532	607	532	560	715	430

Dimensions mm

Supply on request: LG 0

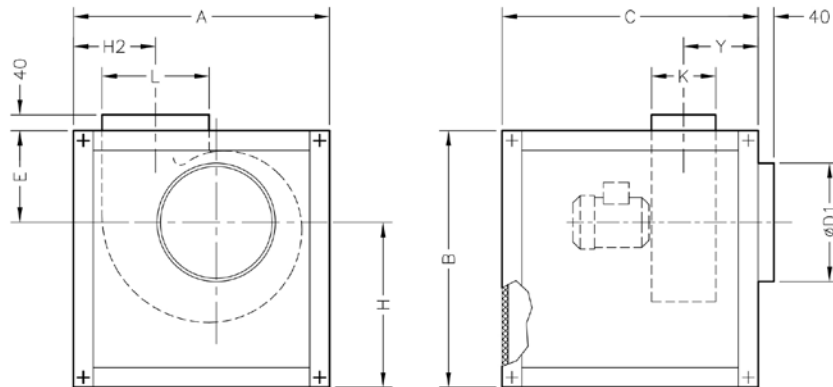

	A	B	C	ØD1	E	H	H2	K	L	Y
CJTCR/R/EW-1240	970	970	970	400	533	437	322	315	400	307.5
CJTCR/R/EW-1445	1070	1070	1070	450	586	484	367	355	450	333.5
CJTCR/R/EW-1650	1160	1160	1160	500	634.5	525.5	391.5	400	500	355
CJTCR/R/EW-1856	1260	1260	1050	560	681.5	578.5	442.5	450	560	360
CJTCR/R/EW-2063	1400	1400	1200	630	759	641	482	500	630	395
CJTCR/R/EW-2271	1555	1555	1355	710	838	717	518.5	560	715	430

Outlet nozzle

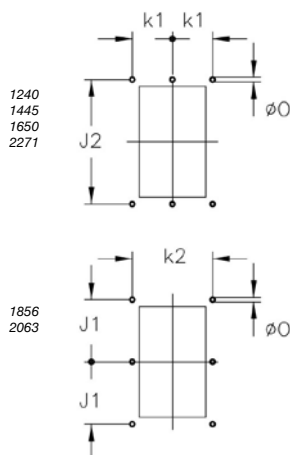

	k1	k2	J1	J2	ØO
CJTCR/R/EW-1240	177.5	-	-	440	11
CJTCR/R/EW-1445	202.5	-	-	498	11
CJTCR/R/EW-1650	225	-	-	550	13
CJTCR/R/EW-1856	-	500	305	-	13
CJTCR/R/EW-2063	-	560	345	-	13
CJTCR/R/EW-2271	312.5	-	-	775	13

Characteristic curves

Q= Flow rate in m³/h, m³/s and cfm

Pe= Static pressure in mm H₂O, Pa and inwg

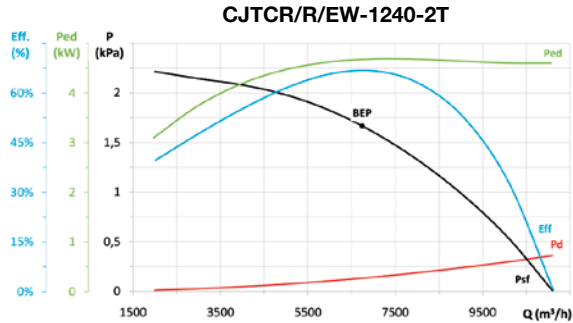

MC	EC	SR	Cc	η_e (%)*	N	[kW]	[m ³ /h]	[Pa]	[rpm]	VSD
A	S	1,02	1,04	69,6%	73,1	4,675	6744	1667,2	2901	NECESSARY

* η_e (%) = Eff. (%) x Cc

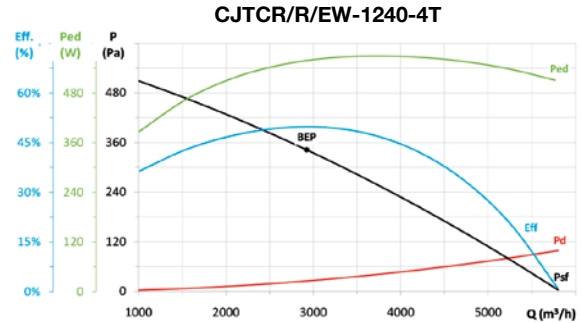

MC	EC	SR	Cc	η_e (%)*	N	[kW]	[m ³ /h]	[Pa]	[rpm]	VSD
A	S	1,00	1,11	55,1%	68,2	0,558	2924	342,3	1453	NECESSARY

* η_e (%) = Eff. (%) x Cc

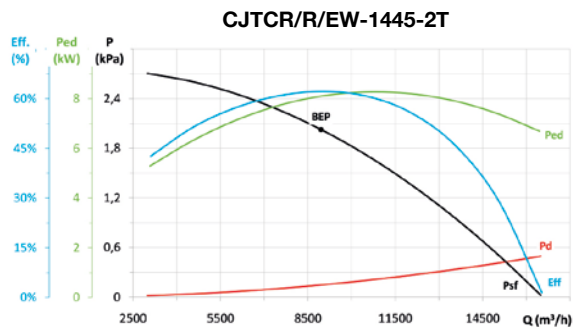

MC	EC	SR	Cc	η_e (%)*	N	[kW]	[m ³ /h]	[Pa]	[rpm]	VSD
A	S	1,02	1,04	64,6%	65,6	8,103	8951	2025,7	2939	NECESSARY

* η_e (%) = Eff. (%) x Cc

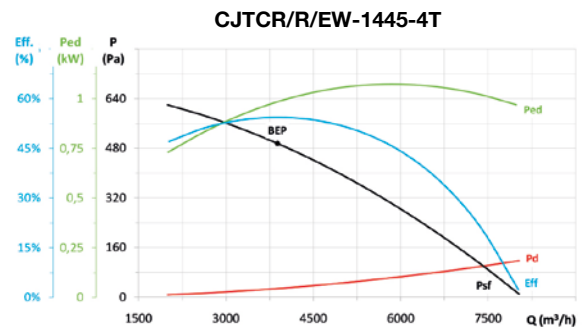

MC	EC	SR	Cc	η_e (%)*	N	[kW]	[m ³ /h]	[Pa]	[rpm]	VSD
A	S	1,01	1,09	59,1%	69,7	0,983	3883	495,3	1468	NECESSARY

* η_e (%) = Eff. (%) x Cc

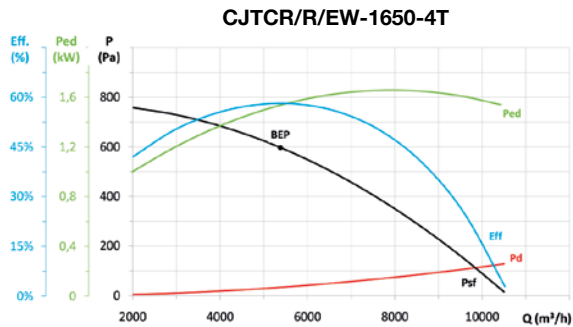

MC	EC	SR	Cc	η_e (%)*	N	[kW]	[m ³ /h]	[Pa]	[rpm]	VSD
A	S	1,01	1,08	62,5%	71,1	1,535	5378	597,4	1449	NECESSARY

* η_e (%) = Eff. (%) x Cc

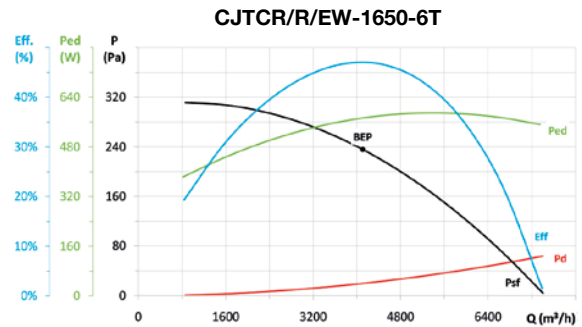

MC	EC	SR	Cc	η_e (%)*	N	[kW]	[m ³ /h]	[Pa]	[rpm]	VSD
A	S	1,00	1,10	52,0%	65,0	0,572	4109	235,7	966	NECESSARY

* η_e (%) = Eff. (%) x Cc

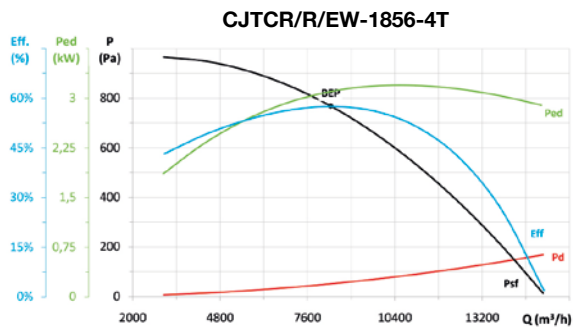

MC	EC	SR	Cc	η_e (%)*	N	[kW]	[m ³ /h]	[Pa]	[rpm]	VSD
A	S	1,01	1,05	60,6%	65,9	3,096	8342	768,0	1448	NECESSARY

* η_e (%) = Eff. (%) x Cc

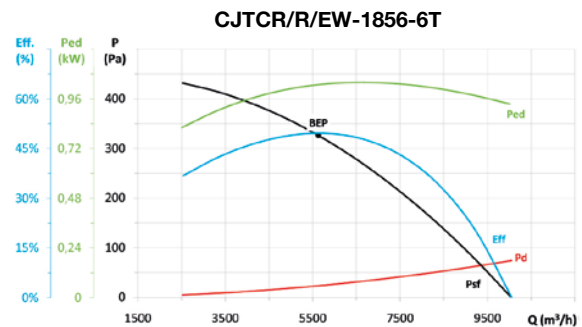

MC	EC	SR	Cc	η_e (%)*	N	[kW]	[m ³ /h]	[Pa]	[rpm]	VSD
A	S	1,00	1,09	53,9%	64,3	1,028	5632	326,1	960	NECESSARY

* η_e (%) = Eff. (%) x Cc

Characteristic curves

Q= Flow rate in m³/h, m³/s and cfm

Pe= Static pressure in mm H₂O, Pa and inwg

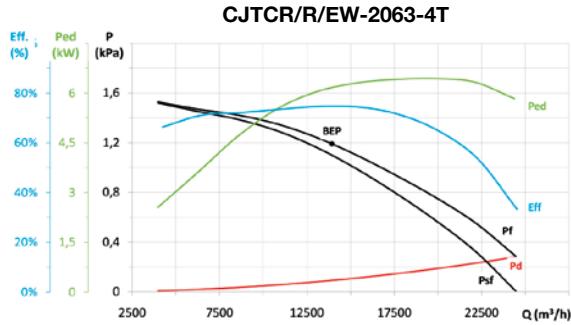

MC	EC	SR	Cc	η_e (%)*	N	[kW]	[m ³ /h]	[Pa]	[rpm]	VSD
B	T	1,01	1,04	77,8%	80,0	6,161	13932	1190,7	1466	NECESSARY

* η_e (%) = Eff. (%) x Cc

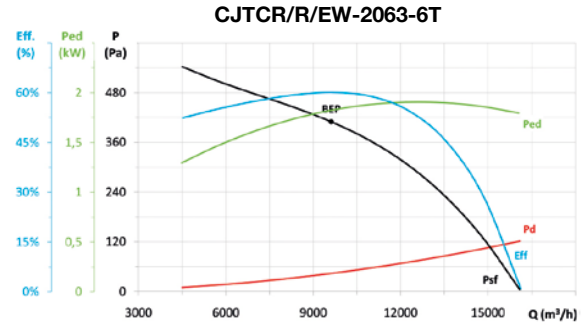

MC	EC	SR	Cc	η_e (%)*	N	[kW]	[m ³ /h]	[Pa]	[rpm]	VSD
A	S	1,00	1,07	64,3%	72,1	1,822	9620	409,7	952	NECESSARY

* η_e (%) = Eff. (%) x Cc

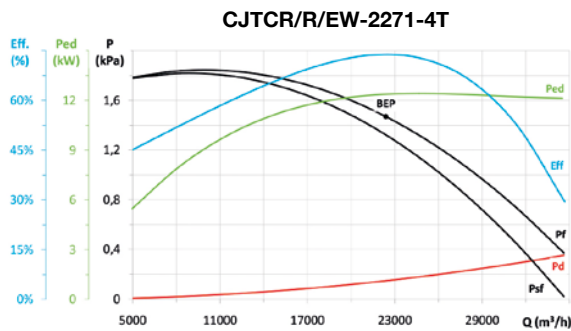

MC	EC	SR	Cc	η_e (%)*	N	[kW]	[m ³ /h]	[Pa]	[rpm]	VSD
B	T	1,01	1,04	76,8%	76,7	12,369	22380	1469,6	1470	NECESSARY

* η_e (%) = Eff. (%) x Cc

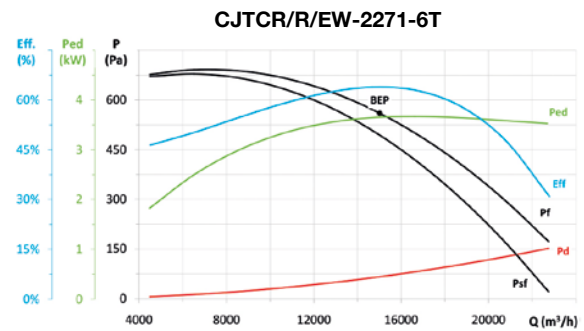

MC	EC	SR	Cc	η_e (%)*	N	[kW]	[m ³ /h]	[Pa]	[rpm]	VSD
B	T	1,01	1,05	67,1%	71,7	3,654	15016	560,2	970	NECESSARY

* η_e (%) = Eff. (%) x Cc

Accessories



TCMP

400 °C/2h centrifugal extractor fans with forward curved impeller



400 °C/2h centrifugal single inlet extractor fans for outdoor operation in fire risk zones.

Fan:

- Sheet steel casing.
- Forward curved impeller in galvanized sheet steel.
- Approved in accordance with standard EN 12101-3, with certificate no.: 0370-CPR- 0313.

Motor:

- Class F motors with ball bearings and IP55 protection.
- Motors with IE3 efficiency for powers equal to or greater than 0,75 kW, except single-phase, 2-speed and 8-pole.

- Three-phase 230/400 V 50 Hz (up to 4 kW) and 400/690 V 50 Hz (powers greater than 4 kW).
- Maximum temperature of air to be carried: S1 -20 °C+ 250 °C continuous service. S2 300 °C/2h and 400 °C/2h service.

Finishing:

- Anti-corrosive finish in polyester resin, polymerised at 190 °C, after degreasing with phosphate-free nanotechnology treatment.

On request:

- Fans with 2 speed motor.
- Belt-driven extractor fans.

Order code

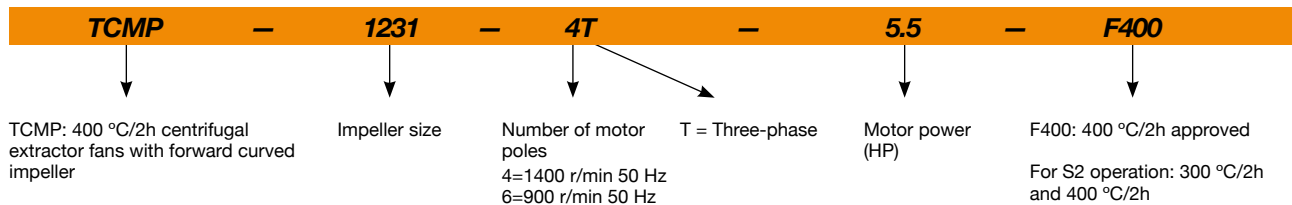

Technical characteristics

Model	Speed (r/min)	Maximum admissible current (A)			Installed power (kW)	Maximum flow rate (m³/h)	Sound pressure level dB (A)	Approx. weight (Kg)
		230V	400V	690V				
TCMP-820-4T	1350	1.66	0.96		0.25	1670	58	11
TCMP-922-4T	1380	2.92	1.69		0.55	2450	59	20
TCMP-1025-4T-1.5 IE3	1455	4.07	2.34		1.10	3400	63	28
TCMP-1025-4T-2 IE3	1440	5.41	3.11		1.50	3650	65	31
TCMP-1128-4T-3 IE3	1435	7.93	4.56		2.20	5000	67	38
TCMP-1128-4T-4 IE3	1440	10.70	6.15		3.00	5450	68	41
TCMP-1128-6T IE3	940	3.36	1.93		0.75	3300	53	30
TCMP-1231-4T-3 IE3	1435	7.93	4.56		2.20	4740	68	45
TCMP-1231-4T-4 IE3	1440	10.70	6.15		3.00	5910	70	48
TCMP-1231-4T-5.5 IE3	1450	13.90	8.00		4.00	6850	72	55
TCMP-1231-6T IE3	950	6.43	3.70		1.50	5120	59	45
TCMP-1435-4T-4 IE3	1440	10.70	6.15		3.00	5400	71	55
TCMP-1435-4T-5.5 IE3	1450	13.90	8.00		4.00	6260	73	62
TCMP-1435-4T-7.5 IE3	1465		10.30	5.97	5.50	7210	75	72
TCMP-1435-4T-10 IE3	1465		13.90	8.06	7.50	9380	74	80
TCMP-1435-6T IE3	950	9.08	5.22		2.20	6400	63	57

Technical characteristics

Model	Speed (r/min)	Maximum admissible current (A)			Installed power (kW)	Maximum flow rate (m³/h)	Sound pressure level dB (A)	Approx. weight (Kg)
		230V	400V	690V				
TCMP-1640-4T-5.5 IE3	1450	13.90	8.00		4.00	7000	72	81
TCMP-1640-4T-7.5 IE3	1465		10.30	5.97	5.50	8040	75	91
TCMP-1640-4T-10 IE3	1465		13.90	8.06	7.50	9710	74	99
TCMP-1640-6T IE3	950	9.08	5.22		2.20	8100	66	76
TCMP-1845-4T-7.5 IE3	1465		10.30	5.97	5.50	8000	79	100
TCMP-1845-4T-10 IE3	1465		13.90	8.06	7.50	10000	79	108
TCMP-1845-6T IE3	950	9.08	5.22		2.20	7500	74	85
TCMP-2050-4T-10 IE3	1465		13.90	8.06	7.50	9000	77	130
TCMP-2050-4T-15 IE3	1470		20.90	12.10	11.00	12520	81	154
TCMP-2050-4T-20 IE3	1465		27.90	16.20	15.00	16500	83	166
TCMP-2050-6T IE3	960	15.60	8.99		4.00	11000	76	125



Erp. (Energy Related Products)

Information on Directive 2009/125/EC can be downloaded from the SODECA website or the QuickFan selector programme.

Acoustic characteristics

The indicated values are determined by measuring the sound pressure level and sound power in dB(A) obtained in a free field at a distance equivalent to twice the size of the fan plus the impeller diameter, with a minimum of 1.5 m.

Sound power spectrum Lw(A) in dB(A) per Hz frequency band

	63	125	250	500	1000	2000	4000	8000		63	125	250	500	1000	2000	4000	8000
TCMP-820-4T	40	50	61	68	72	69	67	60	TCMP-1435-4T-10	57	66	77	84	88	86	84	77
TCMP-922-4T	41	51	62	69	73	70	68	61	TCMP-1435-6T	46	55	66	73	77	75	73	66
TCMP-1025-4T-1.5	45	55	66	73	77	74	72	65	TCMP-1640-4T-5.5	55	64	75	82	86	84	82	75
TCMP-1025-4T-2	47	57	68	75	79	76	74	67	TCMP-1640-4T-7.5	58	67	78	85	89	87	85	78
TCMP-1128-4T-3	49	59	70	77	81	78	76	69	TCMP-1640-4T-10	57	66	77	84	88	86	84	77
TCMP-1128-4T-4	50	60	71	78	82	79	77	70	TCMP-1640-6T	49	58	69	76	80	78	76	69
TCMP-1128-6T	35	45	56	63	67	64	62	55	TCMP-1845-4T-7.5	61	71	82	89	93	91	89	81
TCMP-1231-4T-3	51	60	71	78	82	80	78	71	TCMP-1845-4T-10	61	71	82	89	93	91	89	81
TCMP-1231-4T-4	53	62	73	80	84	82	80	73	TCMP-1845-6T	56	66	77	84	88	86	84	76
TCMP-1231-4T-5.5	55	64	75	82	86	84	82	75	TCMP-2050-4T-10	59	69	80	87	91	89	87	79
TCMP-1231-6T	42	51	62	69	73	71	69	62	TCMP-2050-4T-15	63	73	84	91	95	93	91	83
TCMP-1435-4T-4	54	63	74	81	85	83	81	74	TCMP-2050-4T-20	65	75	86	93	97	95	93	85
TCMP-1435-4T-5.5	56	65	76	83	87	85	83	76	TCMP-2050-6T	58	68	79	86	90	88	86	78
TCMP-1435-4T-7.5	58	67	78	85	89	87	85	78									

Orientations

Standard supply LG 270

Positions LG 180 and RD 180 on request with special anchoring measurements.

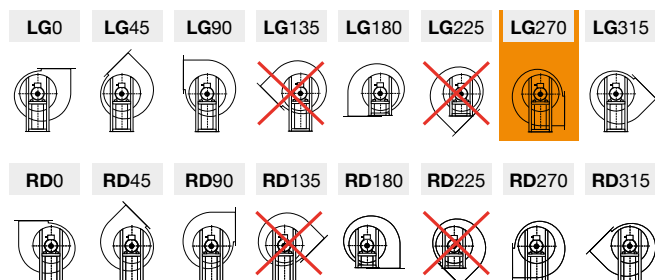

Dimensions mm

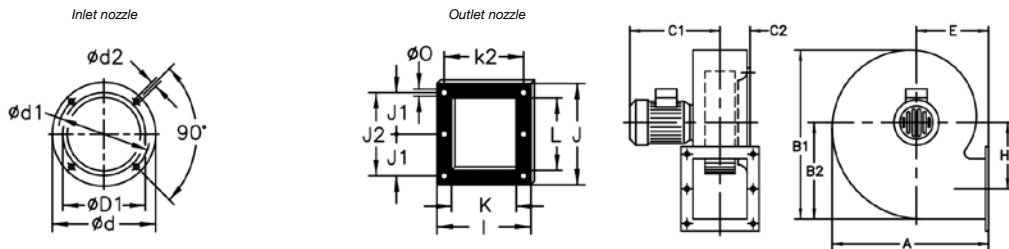

	A	B1	B2	C1	C2	ØD1*	Ød	Ød1	Ød2	E	H1	I	J	J1	J2	K	k2	L	Ø0
TCMP- 820-4T	322	377	223	300	68	203	245	230	M6	137	137	184	213	95	189	134	160	158	9

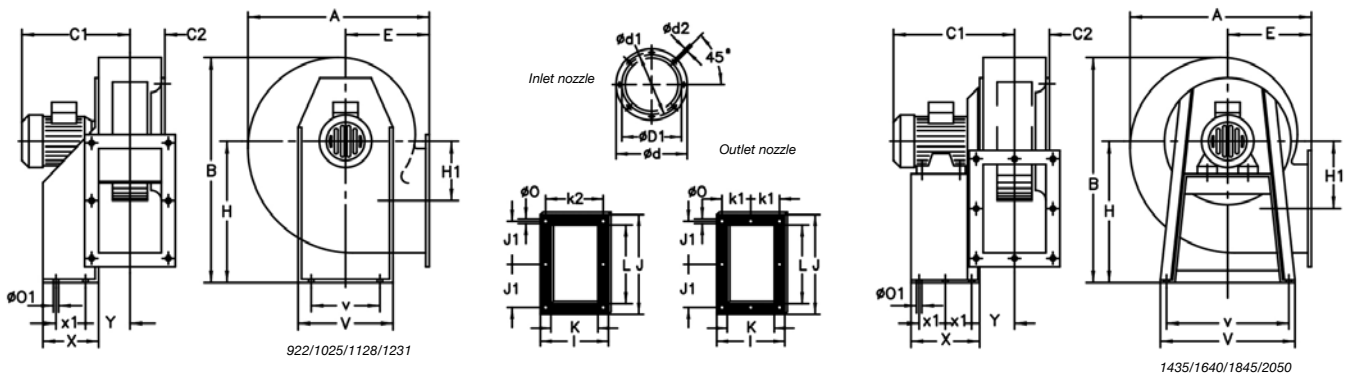

	A	B	C1	C2	ØD1*	Ød	Ød1	Ød2	E	H	H1	I	J	J1	K	k1	k2	L	Ø0	Ø01	V	v	X	x1	Y
TCMP-922	388	455	346	73	230	284	256	M8	180	280	134	204	282	128	140	-	180	217	9.5	10.5	290	220	114	50	104
TCMP-1025	427	503	384	86	261	308	282	M8	197	310	144	229	312	145	165	-	205	252	9.5	12.5	315	228	134	74	115
TCMP-1128-4T	472	553	444	94	287	348	320	M8	216	340	152	244	364	170	180	-	220	299	10	12.5	348	245	144	95	122
TCMP-1128-6T	472	553	359	93	287	348	320	M8	216	340	152	244	364	170	180	-	220	299	10	12.5	348	245	144	95	122
TCMP-1231-3	526	631	432	103	315	382	354	M8	238	390	179	264	382	180	200	-	240	322	12	13	382	322	183	140	125
TCMP-1231-4	526	631	432	103	315	382	354	M8	238	390	179	264	382	180	200	-	240	322	12	13	382	322	183	140	125
TCMP-1231-5.5	526	631	455	103	315	382	354	M8	238	390	179	264	382	180	200	-	240	322	12	13	382	322	183	140	125
TCMP-1231-6T	526	631	432	103	315	382	354	M8	238	390	179	264	382	180	200	-	240	322	12	13	382	322	183	140	125
TCMP-1435-4	573	715	453	118	355	422	394	M8	250	445	242	292	342	159	228	133	-	282	11.5	12	456	420	333	136.5	149.5
TCMP-1435-5.5	573	715	469	118	355	422	394	M8	250	445	242	292	342	159	228	133	-	282	11.5	12	456	420	333	136.5	149.5
TCMP-1435-7.5	573.5	715	512	118	355	422	394	M8	250	445	242	292	342	159	228	133	-	280	11.5	12	456	420	333	136.5	149.5
TCMP-1435-10	573.5	715	512	118	355	422	394	M8	250	445	242	292	342	159	228	133	-	280	11.5	12	456	420	333	136.5	149.5
TCMP-1435-6T	573	715	469	118	355	422	394	M8	250	445	242	292	342	159	228	133	-	282	11.5	12	456	420	333	136.5	149.5
TCMP-1640-5.5	634	799	480	130	402	464	438	M8	270	495	271	336	404	185	250	150	-	324	11.5	12	500	460	327	134	161
TCMP-1640-7.5	634	799	553	130	402	464	438	M8	270	495	271	336	404	185	250	150	-	324	11.5	12	500	460	327	134	161
TCMP-1640-10	634	799	553	130	402	464	438	M8	270	495	271	336	404	185	250	150	-	324	11.5	12	500	460	327	134	161
TCMP-1640-6T	634	799	480	130	402	464	438	M8	270	495	271	336	404	185	250	150	-	324	11.5	12	500	460	327	134	161
TCMP-1845-4T	710	901	570	147	453	515	485	M8	302	560	305	370	444	202	284	164	-	364	11.5	12	538	502	340	140	178
TCMP-1845-6T	710	901	497	147	453	515	485	M8	302	560	305	370	444	202	284	164	-	364	11.5	12	538	502	340	140	178
TCMP-2050-10	797	987	600	162	500	565	535	M8	345	610	313	411	544	250	315	182.5	-	454	11.5	12	653	615	435	187.5	194.5
TCMP-2050-15	797	987	694	162	500	565	535	M8	345	610	313	411	544	250	315	182.5	-	454	11.5	12	653	615	435	187.5	194.5
TCMP-2050-20	797	987	694	162	500	565	535	M8	345	610	313	411	544	250	315	182.5	-	454	11.5	12	653	615	435	187.5	194.5
TCMP-2050-6T	797	987	600	162	500	565	535	M8	345	610	313	411	544	250	315	182.5	-	454	11.5	12	653	615	435	187.5	194.5

* Recommended nominal tube diameter

Characteristic curves

Q= Flow rate in m³/h, m³/s and cfm

Pe= Static pressure in mm H₂O, Pa and inwg

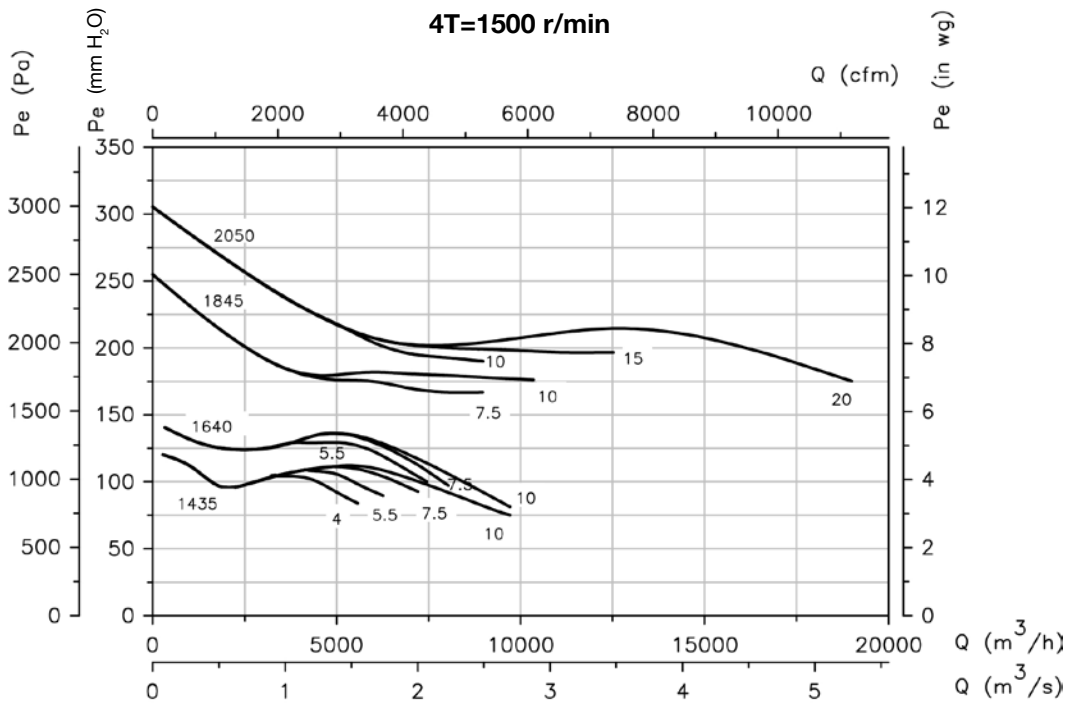
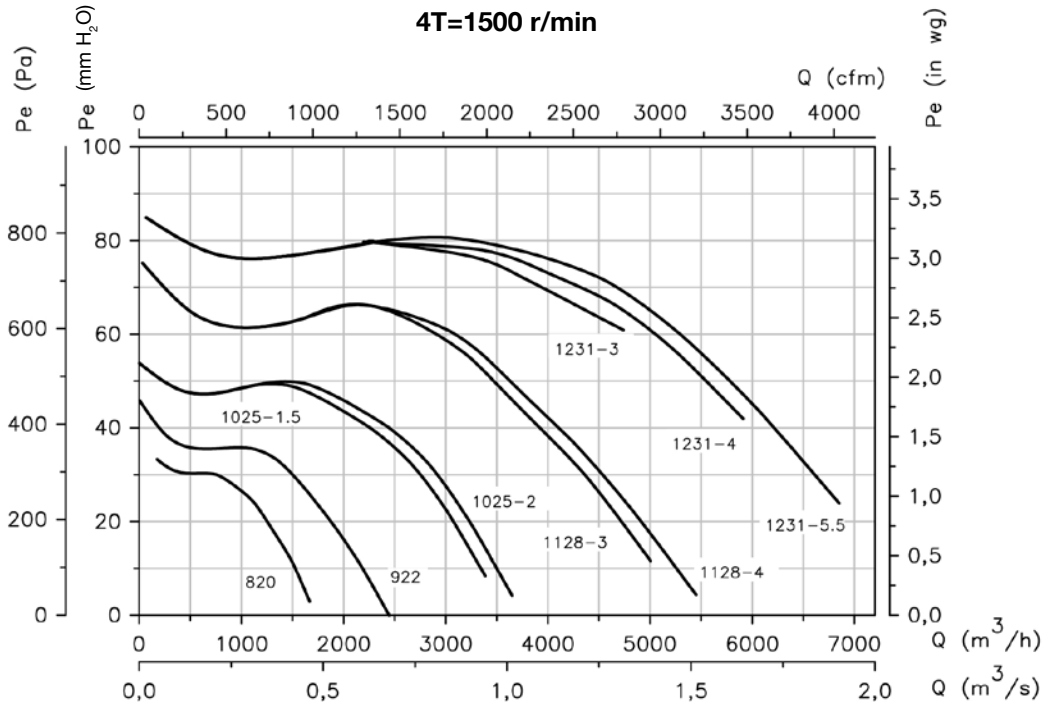

Characteristic curves

Q= Flow rate in m³/h, m³/s and cfm

Pe= Static pressure in mm H₂O, Pa and inwg

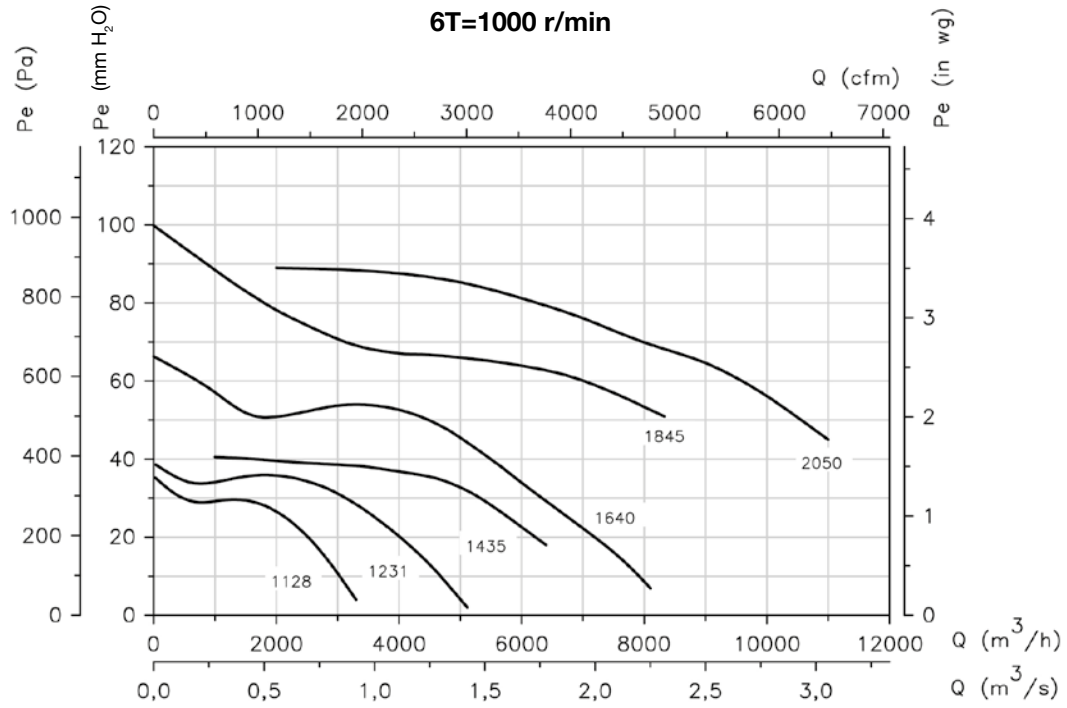

Accessories



INT



IAT



CABLE BOX



C2V



VSD3/A-RFT
- VSD1/A-RFM



CENTRAL CO



AET



RPA



B



BD



BIC



VIS



ACE ACE/400



TEJ



S

CJMP

400 °C/2h centrifugal extractor fan units with forward curved impeller



400 °C/2h single inlet extractor fan units with acoustically insulated box, for outdoor operation in fire risk zones.

Fan:

- Sheet steel casing.
- Forward curved impeller in galvanized sheet steel.
- Approved in accordance with standard EN 12101-3, with certificate no.: 0370-CPR-0402.

Motor:

- Class F motors with ball bearings and IP55 protection.
- Motors with IE3 efficiency for powers equal to or greater than 0,75 kW, except single-phase, 2-speed and 8-pole.

- Three-phase 230/400 V 50 Hz (up to 4 kW) and 400/690 V 50 Hz (powers greater than 4 kW).
- Maximum temperature of air to be carried: S1 -20 °C+ 250 °C continuous service. S2 300 °C/2h and 400 °C/2h service.

Finishing:

- Anti-corrosive in galvanized steel sheet.

On request:

- Fans with 2 speed motor.
- Belt-driven extractor fans.

Order code

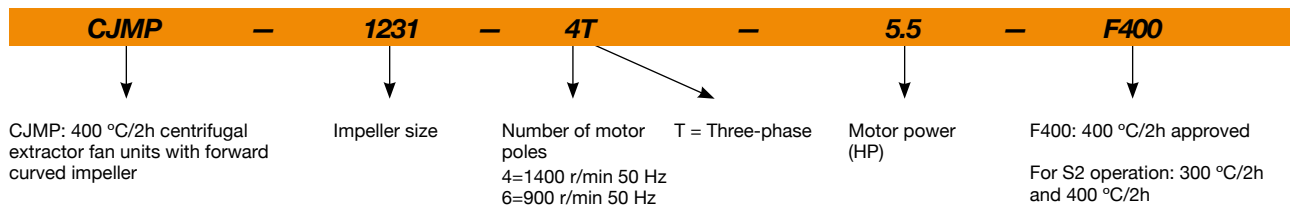

Technical characteristics

Model	Speed (r/min)	Maximum admissible current (A)			Installed power (kW)	Maximum flow rate (m³/h)	Sound pressure level dB (A)	Approx. weight (Kg)
		230V	400V	690V				
CJMP-820-4T	1350	1.66	0.96		0.25	1670	52	25
CJMP-922-4T	1380	2.92	1.69		0.55	2450	53	55
CJMP-1025-4T-1.5 IE3	1455	4.07	2.34		1.10	3400	57	69
CJMP-1025-4T-2 IE3	1440	5.41	3.11		1.50	3650	59	72
CJMP-1128-4T-3 IE3	1435	7.93	4.56		2.20	5000	61	87
CJMP-1128-4T-4 IE3	1440	10.70	6.15		3.00	5450	62	90
CJMP-1128-6T IE3	940	3.36	1.93		0.75	3300	48	79
CJMP-1231-4T-3 IE3	1435	7.93	4.56		2.20	4740	62	103
CJMP-1231-4T-4 IE3	1440	10.70	6.15		3.00	5910	64	106
CJMP-1231-4T-5.5 IE3	1450	13.90	8.00		4.00	6850	66	113
CJMP-1231-6T IE3	950	6.43	3.70		1.50	5120	54	103
CJMP-1435-4T-4 IE3	1440	10.70	6.15		3.00	5400	65	126
CJMP-1435-4T-5.5 IE3	1450	13.90	8.00		4.00	6260	67	133
CJMP-1435-4T-7.5 IE3	1465		10.30	5.97	5.50	7210	69	143
CJMP-1435-4T-10 IE3	1465		13.90	8.06	7.50	9380	74	151
CJMP-1435-6T IE3	950	9.08	5.22		2.20	6400	58	128

Technical characteristics

Model	Speed (r/min)	Maximum admissible current (A)			Installed power (kW)	Maximum flow rate (m³/h)	Sound pressure level dB (A)	Approx. weight (Kg)
		230V	400V	690V				
CJMP-1640-4T-5.5 IE3	1450	13.90	8.00		4.00	7000	66	151
CJMP-1640-4T-7.5 IE3	1465		10.30	5.97	5.50	8040	69	161
CJMP-1640-4T-10 IE3	1465		13.90	8.06	7.50	9710	74	169
CJMP-1640-6T IE3	950	9.08	5.22		2.20	8100	61	146
CJMP-1845-4T-7.5 IE3	1465		10.30	5.97	5.50	8000	73	181
CJMP-1845-4T-10 IE3	1465		13.90	8.06	7.50	10000	79	189
CJMP-1845-6T IE3	950	9.08	5.22		2.20	7500	69	166
CJMP-2050-4T-10 IE3	1465		13.90	8.06	7.50	9000	77	233
CJMP-2050-4T-15 IE3	1470		20.90	12.10	11.00	12520	81	257
CJMP-2050-4T-20 IE3	1465		27.90	16.20	15.00	16500	83	269
CJMP-2050-6T IE3	960	15.60	8.99		4.00	11000	71	228



Erp. (Energy Related Products)

Information on Directive 2009/125/EC can be downloaded from the SODECA website or the QuickFan selector programme.

Acoustic characteristics

The indicated values are determined by measuring the sound pressure level and sound power in dB(A) obtained in a free field at a distance equivalent to twice the size of the fan plus the impeller diameter, with a minimum of 1.5 m.

Sound power spectrum Lw(A) in dB(A) per Hz frequency band

	63	125	250	500	1000	2000	4000	8000		63	125	250	500	1000	2000	4000	8000
CJMP-820-4T	34	44	55	62	66	63	61	54	CJMP-1435-4T-10	57	66	77	84	88	86	84	77
CJMP-922-4T	35	45	56	63	67	64	62	55	CJMP-1435-6T	41	50	61	68	72	70	68	61
CJMP-1025-4T-1.5	39	49	60	67	71	68	66	59	CJMP-1640-4T-5.5	49	58	69	76	80	78	76	69
CJMP-1025-4T-2	41	51	62	69	73	70	68	61	CJMP-1640-4T-7.5	52	61	72	79	83	81	79	72
CJMP-1128-4T-3	43	53	64	71	75	72	70	63	CJMP-1640-4T-10	57	66	77	84	88	86	84	77
CJMP-1128-4T-4	44	54	65	72	76	73	71	64	CJMP-1640-6T	44	53	64	71	75	73	71	64
CJMP-1128-6T	30	40	51	58	62	59	57	50	CJMP-1845-4T-7.5	55	65	76	83	87	85	83	75
CJMP-1231-4T-3	45	54	65	72	76	74	72	65	CJMP-1845-4T-10	61	71	82	89	93	91	89	81
CJMP-1231-4T-4	47	56	67	74	78	76	74	67	CJMP-1845-6T	51	61	72	79	83	81	79	71
CJMP-1231-4T-5.5	49	58	69	76	80	78	76	69	CJMP-2050-4T-10	59	69	80	87	91	89	87	79
CJMP-1231-6T	37	46	57	64	68	66	64	57	CJMP-2050-4T-15	63	73	84	91	95	93	91	83
CJMP-1435-4T-4	48	57	68	75	79	77	75	68	CJMP-2050-4T-20	65	75	86	93	97	95	93	85
CJMP-1435-4T-5.5	50	59	70	77	81	79	77	70	CJMP-2050-6T	53	63	74	81	85	83	81	73
CJMP-1435-4T-7.5	52	61	72	79	83	81	79	72									

Orientations

Standard supply LG 270

Positions LG 180 and RD 180 on request with special anchoring measurements.

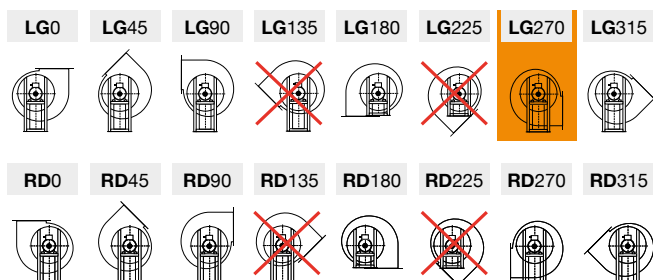

Dimensions mm

Standard supply: LG-270

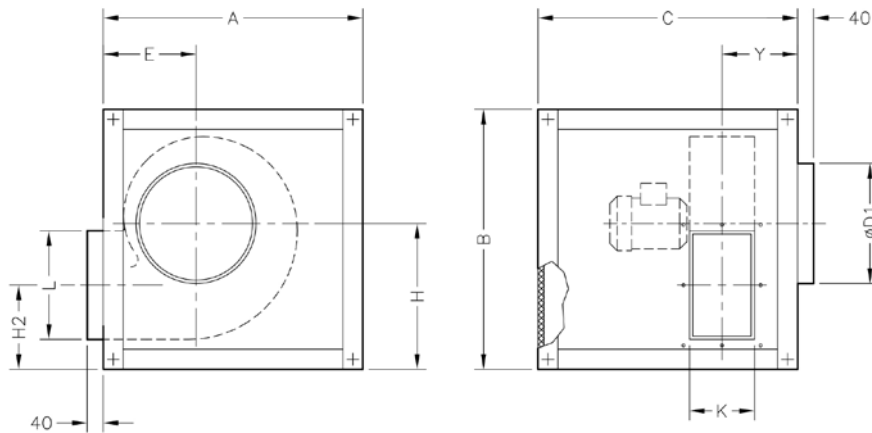

	A	B	C	ØD1	E	H	H2	K	L	Y
CJMP-820	400	450	450	200	142	263	126	130	156	112
CJMP-922	610	610	610	224	187	349	215	140	215	176
CJMP-1025	660	660	660	250	204	379	235	165	250	178.5
CJMP-1128	720	720	720	280	223	409	257	180	295	191
CJMP-1231	800	800	800	315	245	459	279.5	200	320	205
CJMP-1435	880	880	880	355	257	514	271.5	230	280	291
CJMP-1640	970	970	970	400	277	564	293	250	320	324
CJMP-1845	1070	1070	1070	450	309	629	324	284	360	357
CJMP-2050	1160	1160	1160	500	352	679	366	315	450	385.5

Supply on request: LG-90

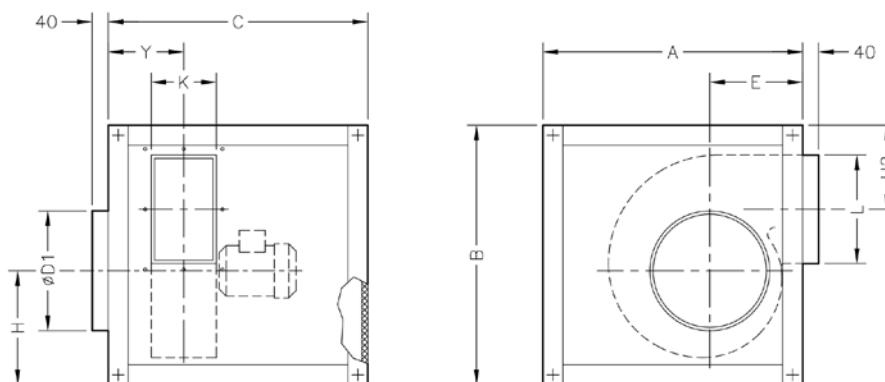

	A	B	C	ØD1	E	H	H2	K	L	Y
CJMP-922	720	720	720	224	187	349	237	140	215	176
CJMP-1025	800	800	800	250	204	379	277	165	250	178
CJMP-1128	880	880	880	280	223	409	319	180	295	191
CJMP-1231	970	970	970	315	245	459	332	200	320	205
CJMP-1435	1070	1070	1070	355	257	514	314	230	280	291
CJMP-1640	1160	1160	1160	400	277	564	325	250	320	325
CJMP-1845	865	1260	1050	450	309	629	326	284	360	357
CJMP-2050	965	1400	1200	500	352	679	408	315	450	383.5

Dimensions mm

Supply on request: LG-0

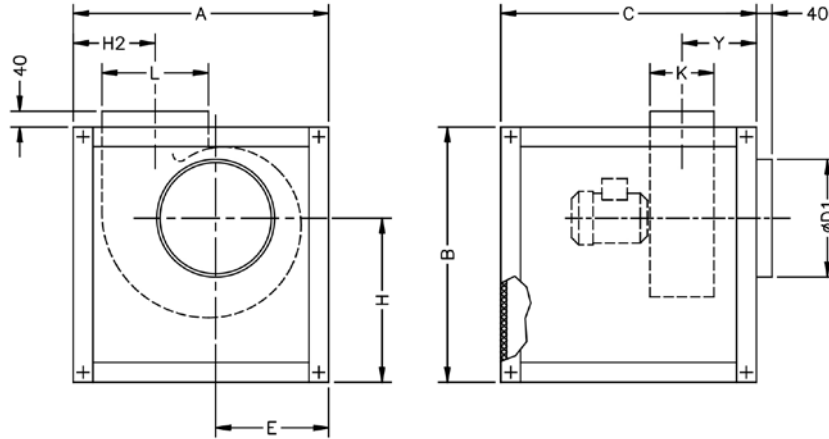

	A	B	C	ØD1	E	H	H2	K	L	Y
CJMP-922	610	610	610	224	279	349	197	140	215	176
CJMP-1025	660	660	660	250	302	379	214	165	250	178.5
CJMP-1128	720	720	720	280	335	409	233	180	295	191
CJMP-1231	800	800	800	315	366	459	255	200	320	205
CJMP-1435	880	880	880	355	385	514	253	230	280	291
CJMP-1640	970	970	970	400	412	564	287	250	320	324
CJMP-1845	1070	1070	1070	450	446	629	319	284	360	357
CJMP-2050	1160	1160	1160	500	485	679	362	315	450	383.5

Outlet nozzle

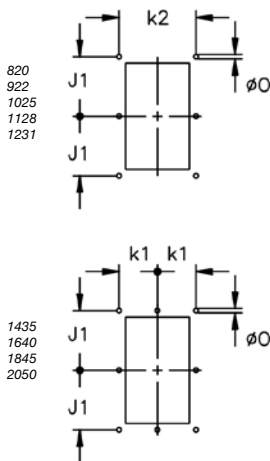

	k1	k2	J1	ØO
CJMP-820	-	160	94.5	9
CJMP-922	-	180	128	9.5
CJMP-1025	-	205	145	9.5
CJMP-1128	-	220	170	9.5
CJMP-1231	-	240	180	11.5
CJMP-1435	133	-	159	11.5
CJMP-1640	150	-	185	11.5
CJMP-1845	164	-	202	11.5
CJMP-2050	182.5	-	250	11.5

Characteristic curves

Q= Flow rate in m³/h, m³/s and cfm

Pe= Static pressure in mm H₂O, Pa and inwg

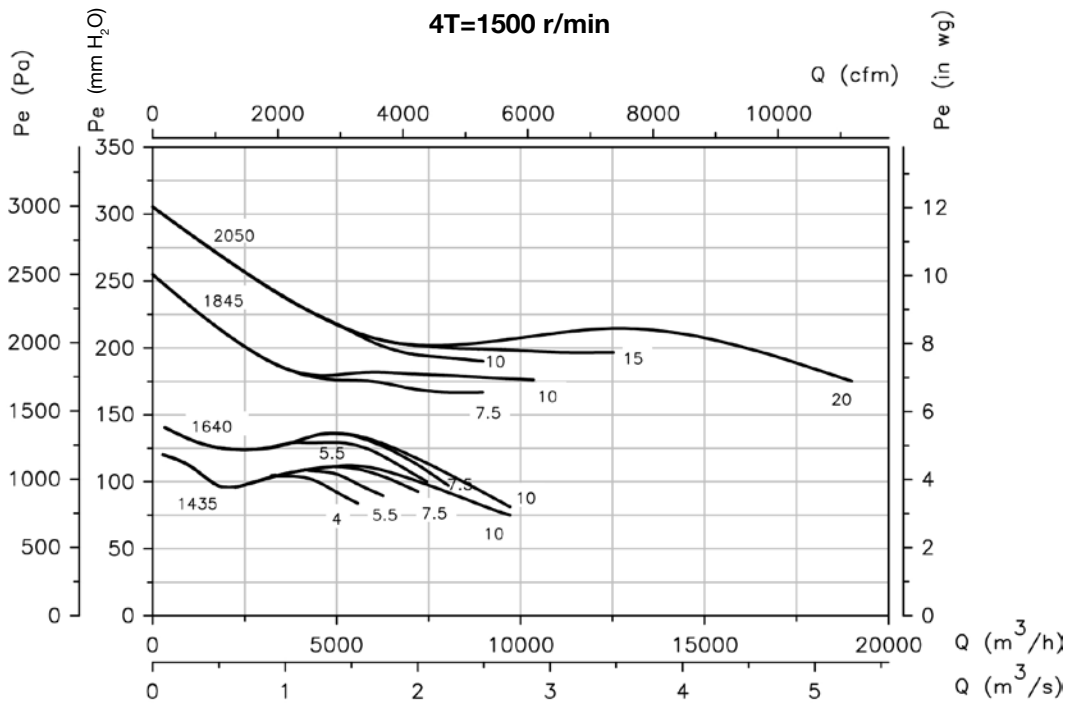
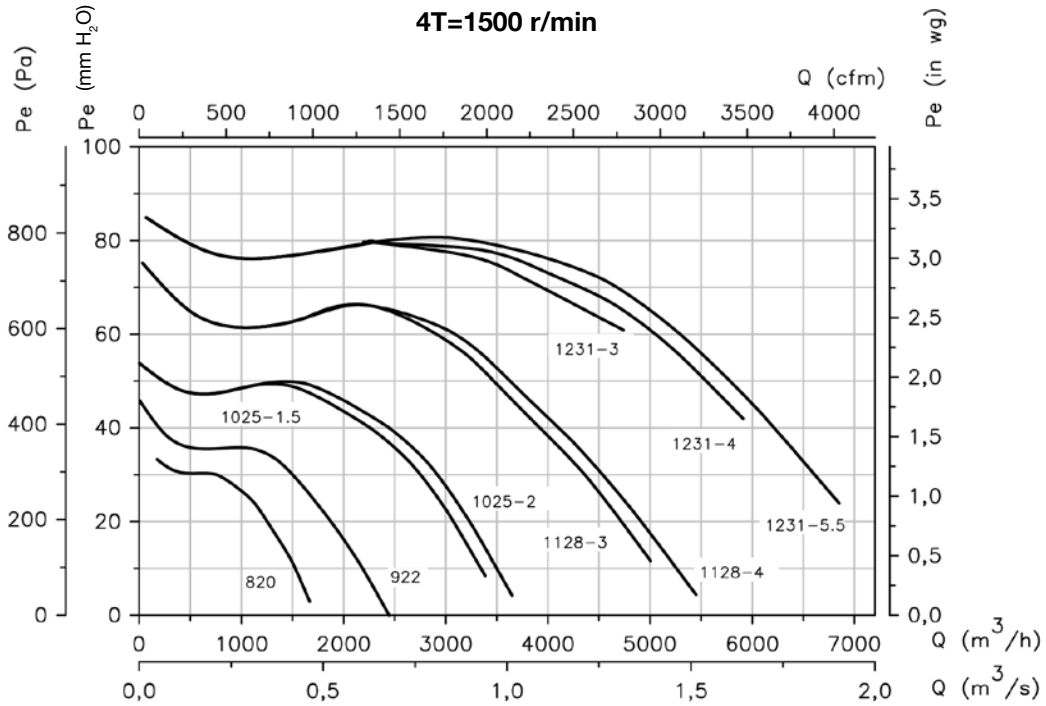

Characteristic curves

Q= Flow rate in m³/h, m³/s and cfm

Pe= Static pressure in mm H₂O, Pa and inwg

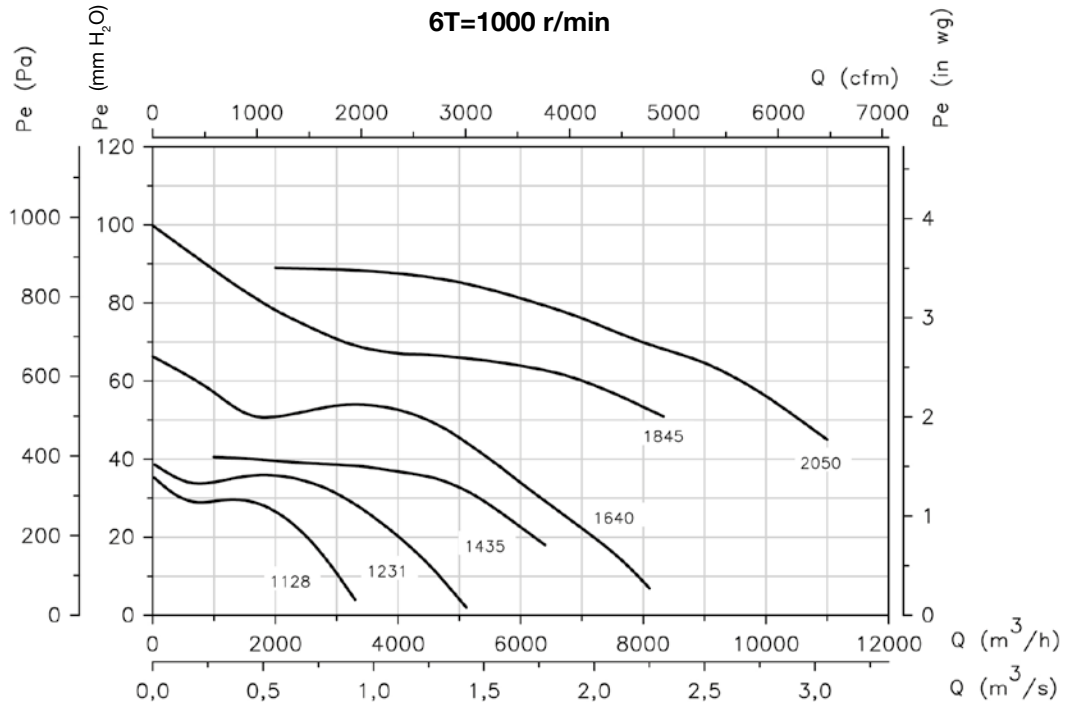

Accessories



INT



IAT



CABLE BOX



C2V



VSD3/A-RFT
- VSD1/A-RFM



CENTRAL CO



AET



RPA



B



BD



BIC



VIS



ACE ACE/400



TEJ

CJTX-C

400°C/2h belt-driven double inlet extractor fan units



400°C/2h extractor fan units, with motor and transmission mounted inside the box, to operate outside the fire risk zone.

Fan:

- Galvanised sheet steel structure.
- Forward curved impeller in galvanised sheet steel.
- Approved in accordance with standard EN 12101-3, with certificate no.: 0370-CPR-0468.
- Linear airflow direction.

Motor:

- Class F motors with ball bearings, IP55 protection and with 1 or 2 speeds, depending on model.

- Motors with IE3 efficiency for powers equal to or greater than 0.75 kW, except single-phase, 2-speed and 8-pole.
- Three-phase 230/400 V 50 Hz (up to 4 kW) and 400/690 V 50 Hz (powers greater than 4 kW).
- Maximum temperature of air to be carried: S1 continuous operation -25 °C +120 °C. S2 operation, 300 °C/2h and 400 °C/2h.

Finish:

- Anti-corrosive in galvanized steel sheet.

On request:

- Fans with vertical outlet.

Order code

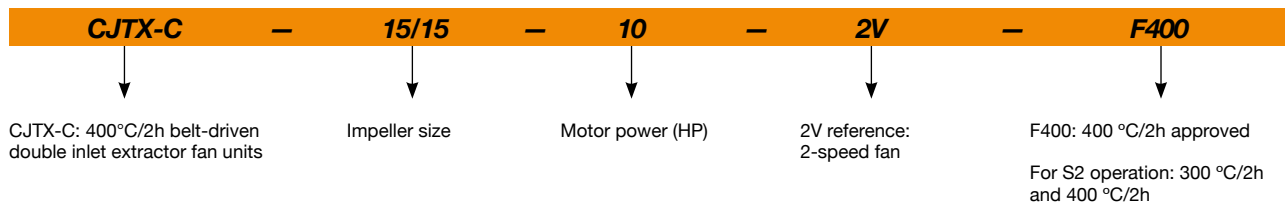

Technical characteristics

Model	Speed (r/min)	Maximum admissible current (A)			Installed power (kW)	Maximum flow rate (m³/h)	Sound pressure level dB (A)	Approx. weight (Kg)
		230V	400V	690V				
CJTX-C-7/7-0.75	1400	2.92	1.69		0.55	2450	57	58
CJTX-C-7/7-0.75-2V	1400 / 695		1.70 / 0.80		0.55 / 0.19	2450 / 1220	57 / 41	58
CJTX-C-7/7-1 IE3	1600	2.82	1.62		0.75	2800	61	63
CJTX-C-7/7-1-2V	1600 / 795		2.00 / 0.90		0.75 / 0.20	2800 / 1390	61 / 46	61
CJTX-C-9/9-0.33-2V	850 / 425		0.70 / 0.30		0.25 / 0.10	2900 / 1450	48 / 32	65
CJTX-C-9/9-0.5	960	2.02	1.17		0.37	3300	51	66
CJTX-C-9/9-0.5-2V	960 / 470		1.05 / 0.50		0.37 / 0.11	3300 / 1600	51 / 36	67
CJTX-C-9/9-0.75	1060	2.92	1.69		0.55	3800	55	69
CJTX-C-9/9-1 IE3	1200	2.82	1.62		0.75	4250	58	74
CJTX-C-9/9-1.5 IE3	1340	4.07	2.34		1.10	4800	61	84
CJTX-C-9/9-2 IE3	1500	5.41	3.11		1.50	5350	65	92
CJTX-C-10/10-0.33	660	1.66	0.96		0.25	3000	44	77
CJTX-C-10/10-0.33-2V	660 / 330		0.70 / 0.30		0.25 / 0.10	3000 / 1500	44 / 29	77
CJTX-C-10/10-0.5	800	2.02	1.17		0.37	3400	49	77
CJTX-C-10/10-0.5-2V	800 / 390		1.05 / 0.50		0.37 / 0.11	3400 / 1650	49 / 34	79
CJTX-C-10/10-0.75	880	2.92	1.69		0.55	4000	54	81

Technical characteristics

Model	Speed (r/min)	Maximum admissible current (A)			Installed power (kW)	Maximum flow rate (m ³ /h)	Sound pressure level dB (A)	Approx. weight (Kg)
		230V	400V	690V				
CJTX-C-10/10-0.75-2V	880 / 440		1.70 / 0.80		0.55 / 0.19	4000 / 1990	54 / 38	81
CJTX-C-10/10-1 IE3	1000	2.82	1.62		0.75	4350	58	86
CJTX-C-10/10-1-2V	1000 / 500		2 / 0.9		0.75 / 0.20	4350 / 2160	58 / 43	84
CJTX-C-10/10-1.5 IE3	1130	4.07	2.34		1.10	5000	61	96
CJTX-C-10/10-2 IE3	1270	5.41	3.11		1.50	5450	63	102
CJTX-C-10/10-3 IE3	1450	7.93	4.56		2.20	6200	67	90
CJTX-C-12/12-0.5	600	2.02	1.17		0.37	4300	54	96
CJTX-C-12/12-0.5-2V	600 / 295		1.05 / 0.50		0.37 / 0.11	4300 / 2090	54 / 38	98
CJTX-C-12/12-0.75	700	2.92	1.69		0.55	4850	57	99
CJTX-C-12/12-0.75-2V	700 / 350		1.70 / 0.80		0.55 / 0.19	4850 / 2410	57 / 42	100
CJTX-C-12/12-1 IE3	800	2.82	1.62		0.75	5250	60	105
CJTX-C-12/12-1-2V	800 / 400		2.00 / 0.90		0.75 / 0.20	5250 / 2610	60 / 45	103
CJTX-C-12/12-1.5 IE3	880	4.07	2.34		1.10	6150	63	115
CJTX-C-12/12-1.5-2V	880 / 435		2.90 / 1.30		1.10 / 0.25	6150 / 3030	63 / 48	104
CJTX-C-12/12-2 IE3	1020	5.41	3.11		1.50	6600	67	121
CJTX-C-12/12-3 IE3	1140	7.93	4.56		2.20	7600	69	108
CJTX-C-12/12-4 IE3	1250	10.70	6.15		3.00	8550	71	120
CJTX-C-15/15-0.75	530	2.92	1.69		0.55	6000	47	126
CJTX-C-15/15-0.75-2V	530 / 260		1.60 / 0.65		0.55 / 0.09	6000 / 2900	47 / 31	126
CJTX-C-15/15-1 IE3	560	2.82	1.62		0.75	7000	50	131
CJTX-C-15/15-1.5 IE3	630	4.07	2.34		1.10	8050	54	142
CJTX-C-15/15-2 IE3	700	5.41	3.11		1.50	8900	58	149
CJTX-C-15/15-3 IE3	800	7.93	4.56		2.20	10100	64	136
CJTX-C-15/15-4 IE3	880	10.70	6.15		3.00	11350	65	149
CJTX-C-15/15-5.5 IE3	970	13.90	8.00		4.00	12600	68	147
CJTX-C-18/18-1 IE3	460	2.82	1.62		0.75	10100	48	164
CJTX-C-18/18-1-2V	460 / 215		2.20 / 0.87		0.75 / 0.15	10100 / 4700	48 / 31	163
CJTX-C-18/18-1.5 IE3	510	4.07	2.34		1.10	11800	52	175
CJTX-C-18/18-1.5-2V	510 / 255		3.00 / 1.15		1.10 / 0.18	11800 / 5840	52 / 36	165
CJTX-C-18/18-2 IE3	540	5.41	3.11		1.50	13800	55	183
CJTX-C-18/18-2-2V	540 / 265		4.60 / 1.90		1.50 / 0.25	13800 / 6690	55 / 39	167
CJTX-C-18/18-3 IE3	610	7.93	4.56		2.20	15850	60	171
CJTX-C-18/18-3-2V	610 / 305		5.60 / 2.20		2.20 / 0.37	15850 / 7920	60 / 45	173
CJTX-C-18/18-4 IE3	680	10.70	6.15		3.00	17600	64	182
CJTX-C-18/18-4-2V	680 / 340		9.00 / 3.50		3.00 / 0.55	17600 / 8800	64 / 49	180
CJTX-C-18/18-5.5 IE3	750	13.90	8.00		4.00	19450	68	180
CJTX-C-18/18-5.5-2V	750 / 375		11.00 / 4.00		4.00 / 0.65	19450 / 9620	68 / 52	184
CJTX-C-18/18-7.5 IE3	850		10.30	5.97	5.50	21350	72	211
CJTX-C-18/18-7.5-2V	850 / 425		13.20 / 5.30		5.50 / 1.00	21350 / 10560	72 / 57	204
CJTX-C-18/18-10 IE3	930		13.90	8.06	7.50	24000	75	218
CJTX-C-20/20-2 IE3	450	5.41	3.11		1.50	14000	53	284
CJTX-C-20/20-3 IE3	530	7.93	4.56		2.20	15800	59	271
CJTX-C-20/20-4 IE3	580	10.70	6.15		3.00	17950	63	282
CJTX-C-20/20-5.5 IE3	660	13.90	8.00		4.00	19050	67	281
CJTX-C-20/20-7.5 IE3	740		10.30	5.97	5.50	21150	68	312
CJTX-C-20/20-10 IE3	815		13.90	8.06	7.50	23650	70	320
CJTX-C-22/22-2 IE3	380	5.41	3.11		1.50	16000	52	326
CJTX-C-22/22-2-2V	380 / 185		4.60 / 1.90		1.50 / 0.25	16000 / 7750	52 / 37	310
CJTX-C-22/22-3 IE3	430	7.93	4.56		2.20	18400	56	313
CJTX-C-22/22-3-2V	430 / 215		5.60 / 2.20		2.20 / 0.37	18400 / 9200	56 / 41	316
CJTX-C-22/22-4 IE3	480	10.70	6.15		3.00	20350	60	325
CJTX-C-22/22-5.5 IE3	520	13.90	8.00		4.00	23250	64	325
CJTX-C-22/22-7.5 IE3	580		10.30	5.97	5.50	25950	68	356
CJTX-C-22/22-10 IE3	650		13.90	8.06	7.50	28250	71	362

Technical characteristics

Model	Speed (r/min)	Maximum admissible current (A)			Installed power (kW)	Maximum flow rate (m³/h)	Sound pressure level dB (A)	Approx. weight (Kg)
		230V	400V	690V				
CJTX-C-22/22-15 IE3	740		20.90	12.10	11.00	31950	73	383
CJTX-C-22/22-20 IE3	780		27.90	16.20	15.00	34000	75	441
CJTX-C-25/25-3 IE3	340	7.93	4.56		2.20	21550	60	370
CJTX-C-25/25-3-2V	340 / 170		5.60 / 2.20		2.20 / 0.37	21550 / 10780	60 / 45	372
CJTX-C-25/25-4 IE3	380	10.70	6.15		3.00	23850	64	381
CJTX-C-25/25-4-2V	380 / 190		9.00 / 3.50		3.00 / 0.55	23850 / 11920	64 / 49	379
CJTX-C-25/25-5.5 IE3	420	13.90	8.00		4.00	26300	69	379
CJTX-C-25/25-5.5-2V	420 / 210		11.00 / 4.00		4.00 / 0.65	26300 / 13010	69 / 53	383
CJTX-C-25/25-7.5 IE3	470		10.30	5.97	5.50	29250	69	416
CJTX-C-25/25-7.5-2V	470 / 235		13.20 / 5.30		5.50 / 1.00	29250 / 14470	69 / 53	409
CJTX-C-25/25-10 IE3	510		13.90	8.06	7.50	33150	71	417
CJTX-C-25/25-10-2V	510 / 255		16.90 / 5.50		7.50 / 1.30	33150 / 16490	71 / 56	412
CJTX-C-25/25-15 IE3	570		20.90	12.10	11.00	38300	74	444
CJTX-C-25/25-15-2V	570 / 285		23.20 / 8.70		11.00 / 2.80	38300 / 19050	74 / 59	450
CJTX-C-25/25-20 IE3	630		27.90	16.20	15.00	38750	77	499
CJTX-C-30/28-3 IE3	250	7.93	4.56		2.20	25550	55	503
CJTX-C-30/28-3-2V	250 / 125		5.60 / 2.20		2.20 / 0.37	25550 / 12780	55 / 40	507
CJTX-C-30/28-4 IE3	280	10.70	6.15		3.00	28250	60	521
CJTX-C-30/28-4-2V	280 / 140		9.00 / 3.50		3.00 / 0.55	28250 / 14120	60 / 45	519
CJTX-C-30/28-5.5 IE3	340	13.90	8.00		4.00	28750	64	519
CJTX-C-30/28-5.5-2V	340 / 170		11.00 / 4.00		4.00 / 0.65	28750 / 14230	64 / 49	523
CJTX-C-30/28-7.5 IE3	360		10.30	5.97	5.50	33600	69	553
CJTX-C-30/28-7.5-2V	360 / 180		13.20 / 5.30		5.50 / 1.00	33600 / 16630	69 / 54	546
CJTX-C-30/28-10 IE3	410		13.90	8.06	7.50	36400	74	561
CJTX-C-30/28-10-2V	410 / 205		16.90 / 5.50		7.50 / 1.30	36400 / 18110	74 / 59	556
CJTX-C-30/28-15 IE3	480		20.90	12.10	11.00	40250	74	582
CJTX-C-30/28-15-2V	480 / 240		23.20 / 8.70		11.00 / 2.80	40250 / 20020	74 / 59	588
CJTX-C-30/28-20 IE3	520		27.90	16.20	15.00	45600	77	644
CJTX-C-30/28-20-2V	520 / 260		31.72 / 11.75		15.00 / 3.80	45600 / 22680	77 / 62	616
CJTX-C-30/28-25 IE3	550		35.10	20.30	18.50	49500	79	641
CJTX-C-30/28-25-2V	550 / 275		33.00 / 11.00		17.00 / 3.40	49500 / 24620	79 / 64	643



Erp. (Energy Related Products)

Information on Directive 2009/125/EC can be downloaded from the SODECA website or the QuickFan selector programme.

Accessories

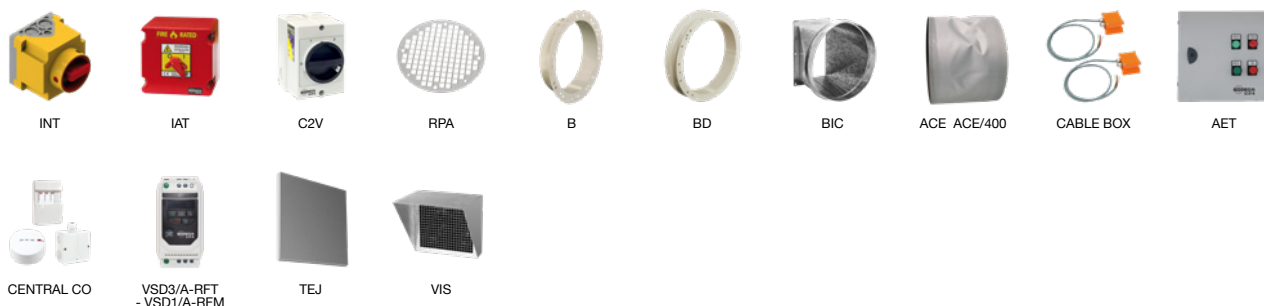

Dimensions mm

Standard supply horizontal impulsion
(H) LG 90

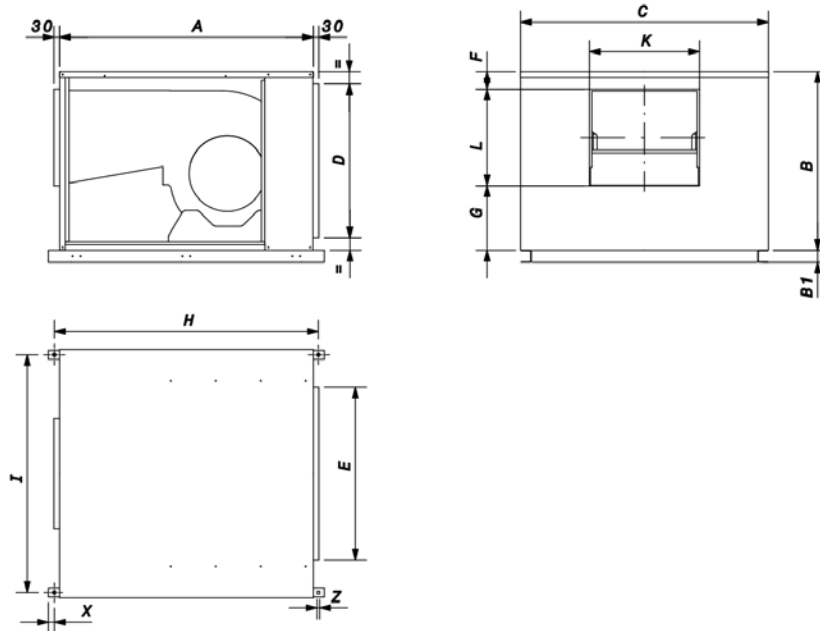

	A	B	B1	C	D	E	F	G	H	I	K	L	X	Z
CJTX-C-7/7	700	480	-	730	354	470	62	202	724	690	239	216	12	9
CJTX-C-9/9	785	592	-	759	466	490	92	226	812	721	310	270	12	9
CJTX-C-10/10	860	618	-	825	492	520	87	235	884	787	334	296	12	9
CJTX-C-12/12	970	680	-	945	554	620	80	250	995	896	395	350	12	9
CJTX-C-15/15	1100	776	-	1100	650	720	80	285	1124	1062	483	411	12	9
CJTX-C-18/18	1278	900	60	1250	774	870	90	325	1328	1197	552	486	30.3	13
CJTX-C-20/20	1495	1050	60	1474	954	1100	100	336	1555	1419	618	615	32.5	13
CJTX-C-22/22	1640	1180	60	1625	954	1100	125	350	1711	1570	665	705	22	13
CJTX-C-25/25	1800	1300	60	1825	1174	1450	125	369	1871	1770	780	806	22	13
CJTX-C-30/28	2000	1525	60	2134	1399	1760	118	465	2060	2085	900	942	20	13

Dimensions mm

Vertical impulsion on request
(V) LG 0

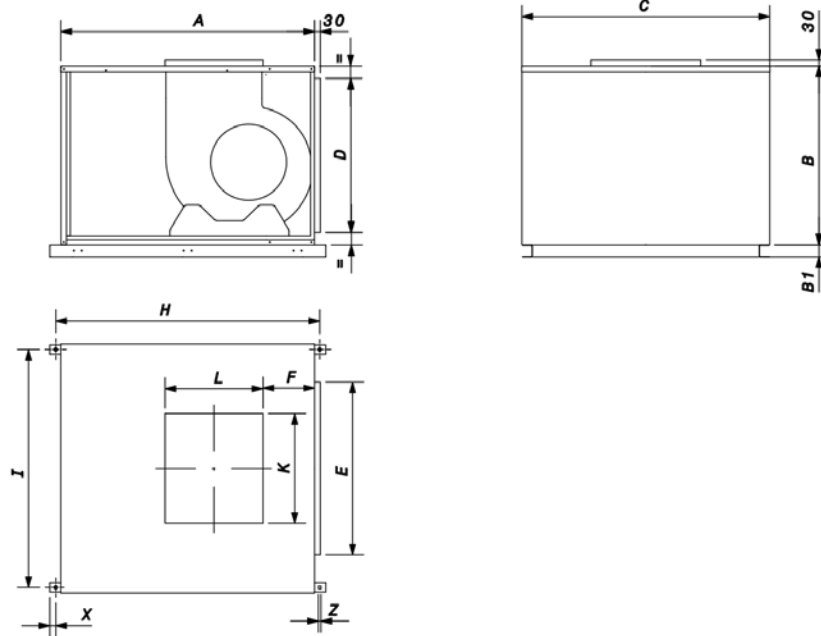

	A	B	B1	C	D	E	F	H	I	K	L	X	Z
CJTX-C-7/7	700	480	-	730	354	470	186	724	690	239	219	12	9
CJTX-C-9/9	785	592	-	759	466	490	170	812	721	305	272	12	9
CJTX-C-10/10	860	618	-	825	492	520	161	884	787	333	300	12	9
CJTX-C-12/12	970	680	-	945	554	620	202	995	896	397	355	12	9
CJTX-C-15/15	1100	776	-	1100	650	720	220	1124	1062	485	415	12	9
CJTX-C-18/18	1278	900	60	1250	774	870	259	1328	1197	550	495	30.3	13
CJTX-C-20/20	1495	1050	60	1474	954	1100	312	1555	1419	617	611	32.5	13
CJTX-C-22/22	1640	1180	60	1625	954	1100	307	1711	1570	666	705	22	13
CJTX-C-25/25	1800	1300	60	1825	1174	1450	334	1871	1770	775	808	22	13
CJTX-C-30/28	2000	1525	60	2134	1399	1760	417	2060	2085	900	947	20	13

Characteristic curves

Q= Flow rate in m³/h, m³/s and cfm

Pe= Static pressure in mm H₂O, Pa and inwg

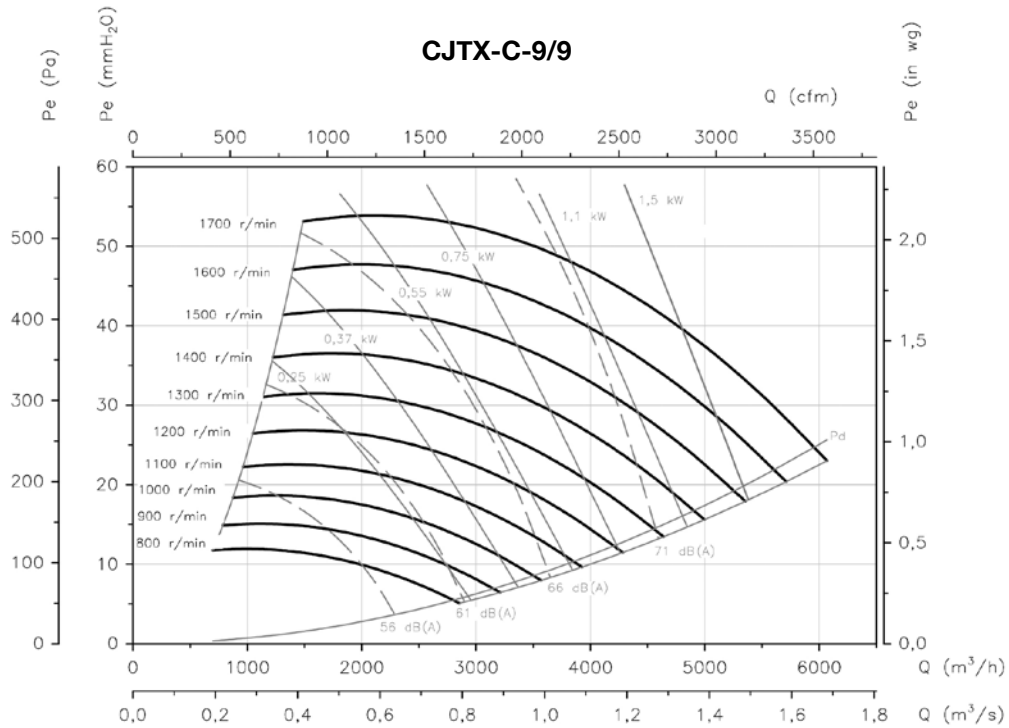
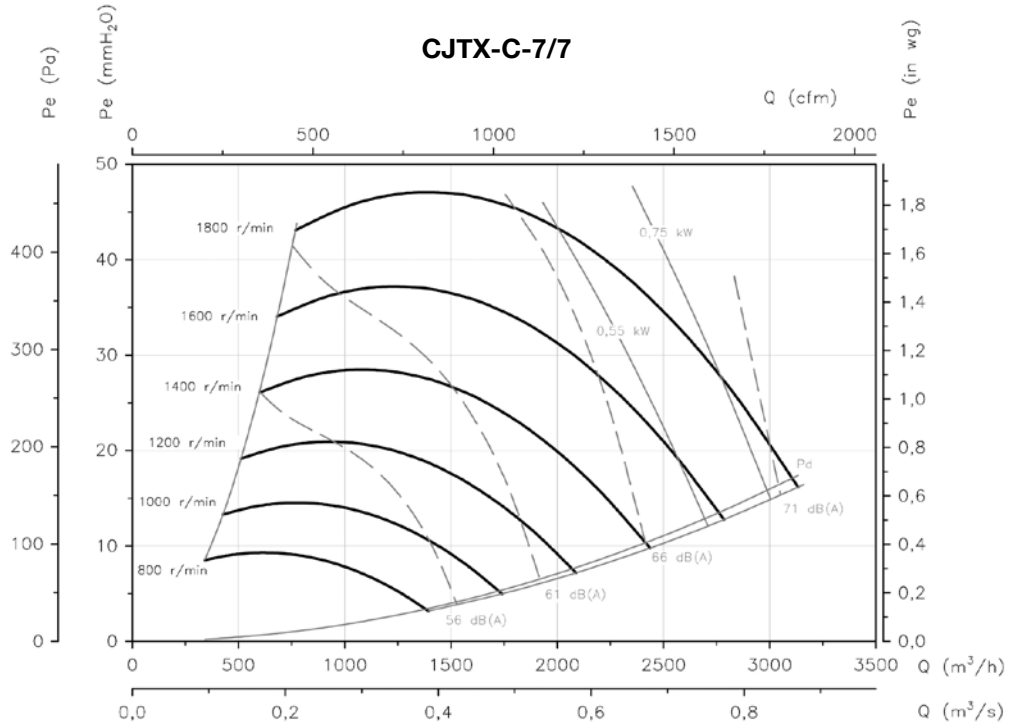

Characteristic curves

Q= Flow rate in m³/h, m³/s and cfm

Pe= Static pressure in mm H₂O, Pa and inwg

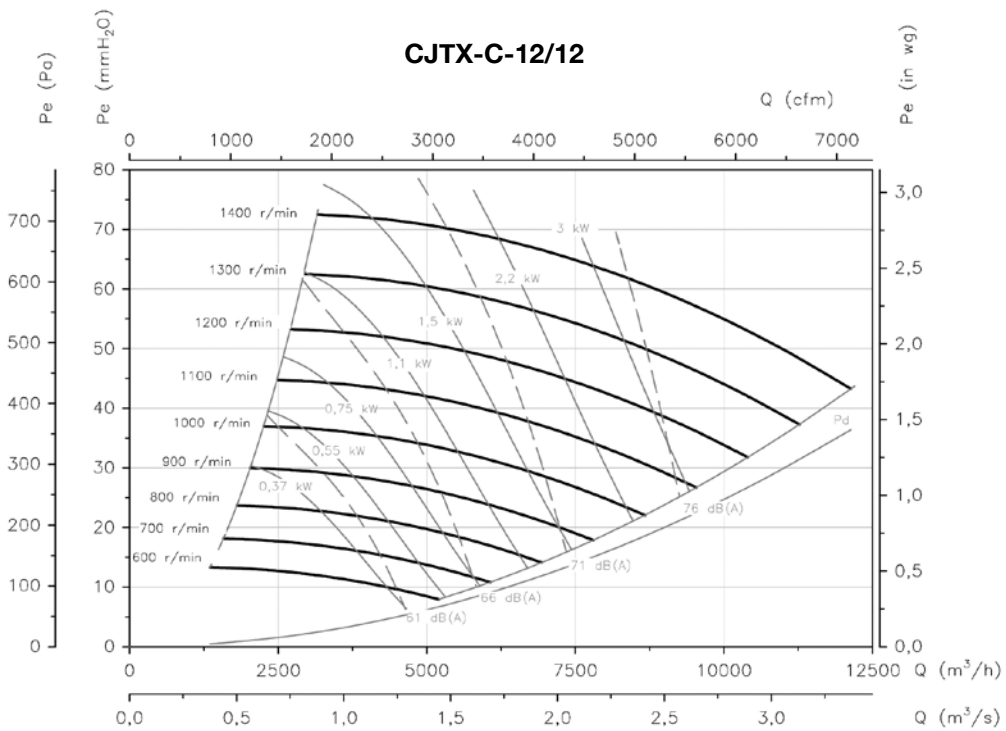
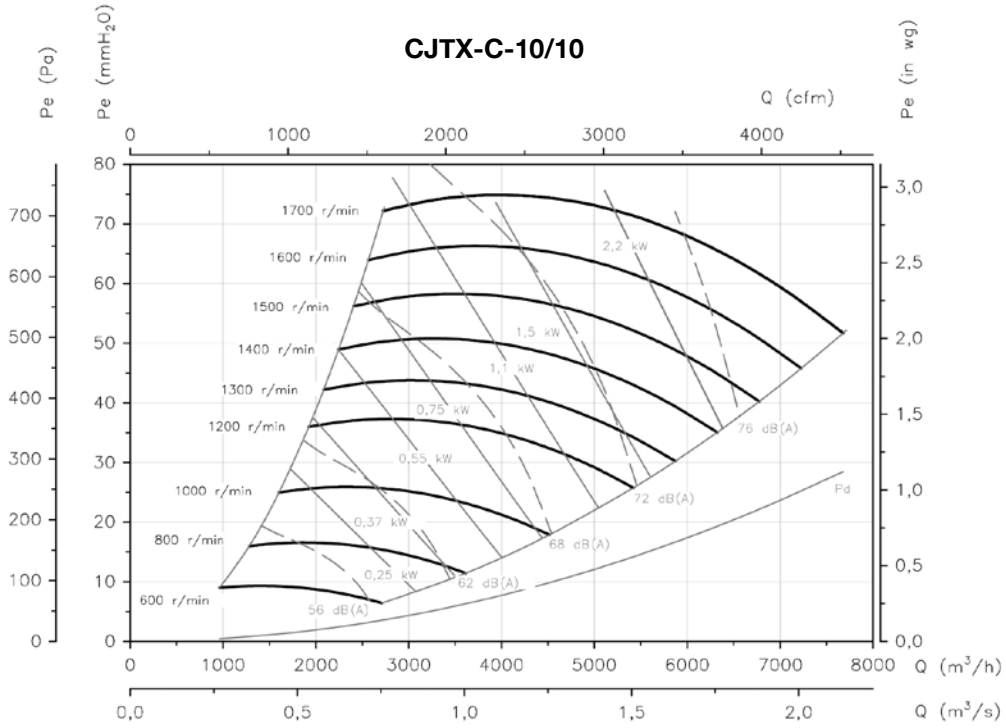

Characteristic curves

Q= Flow rate in m³/h, m³/s and cfm

Pe= Static pressure in mm H₂O, Pa and inwg

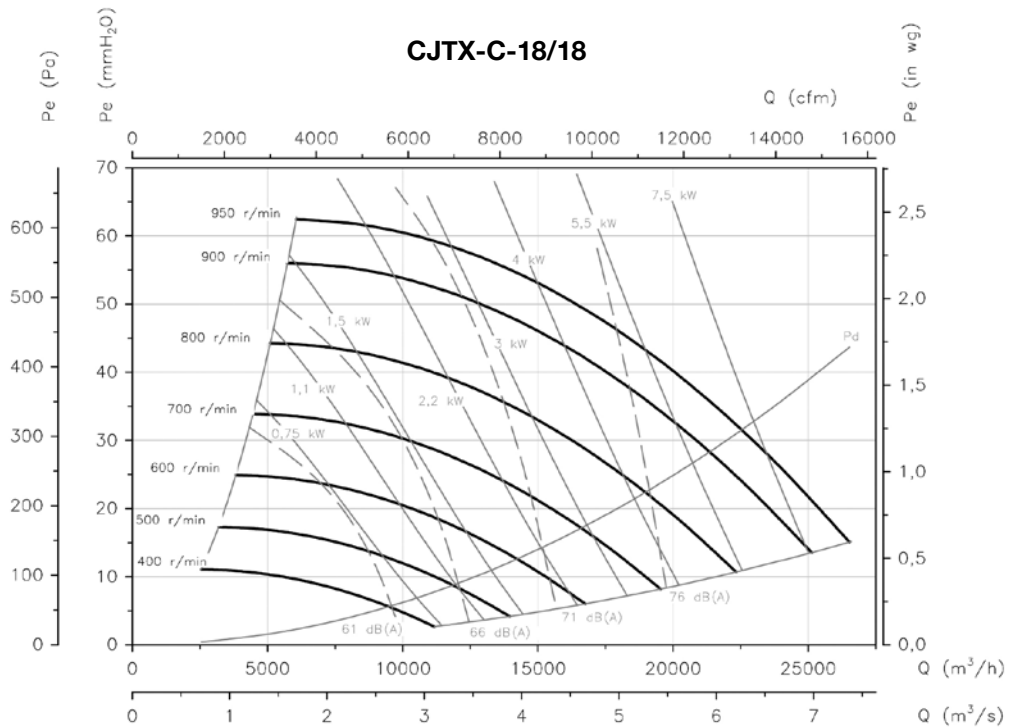
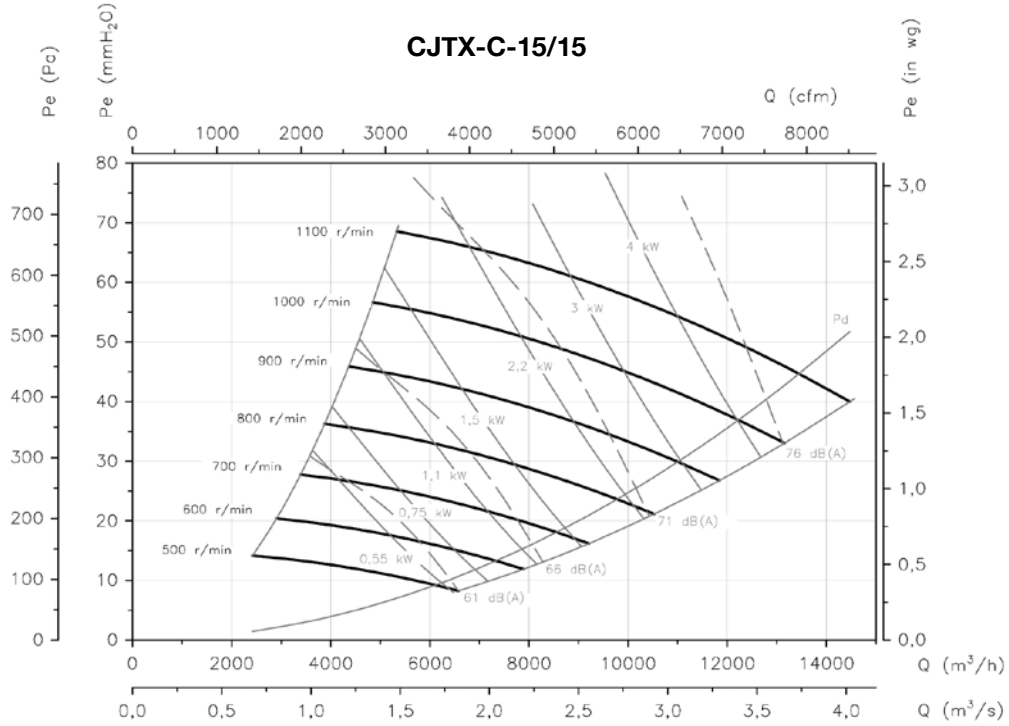

Characteristic curves

Q= Flow rate in m³/h, m³/s and cfm

Pe= Static pressure in mm H₂O, Pa and inwg

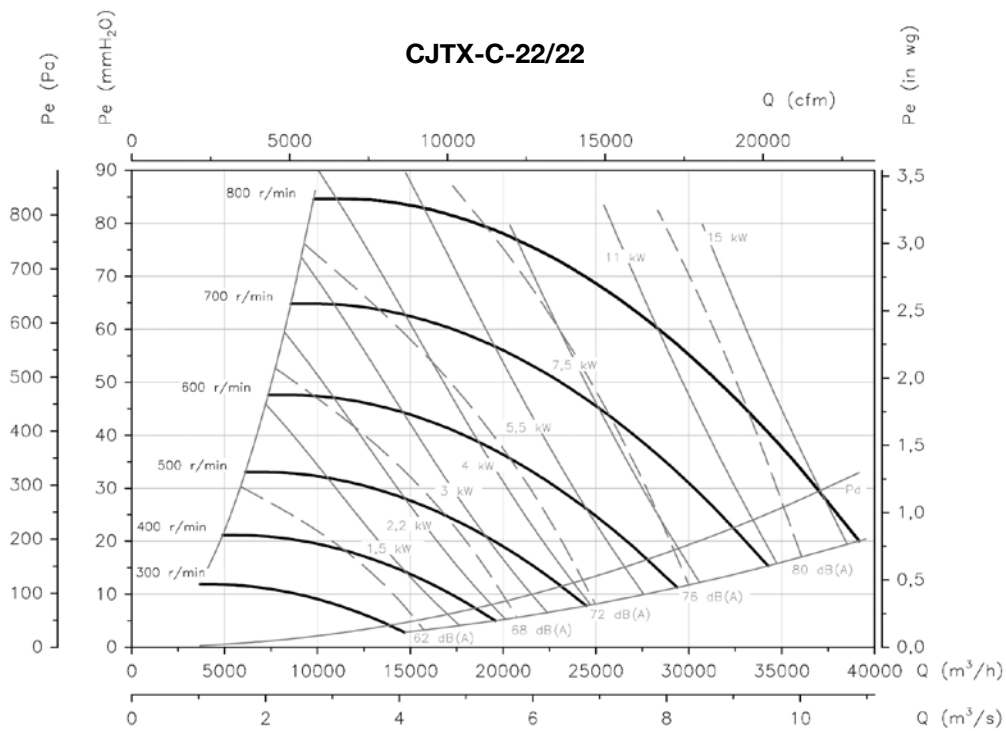
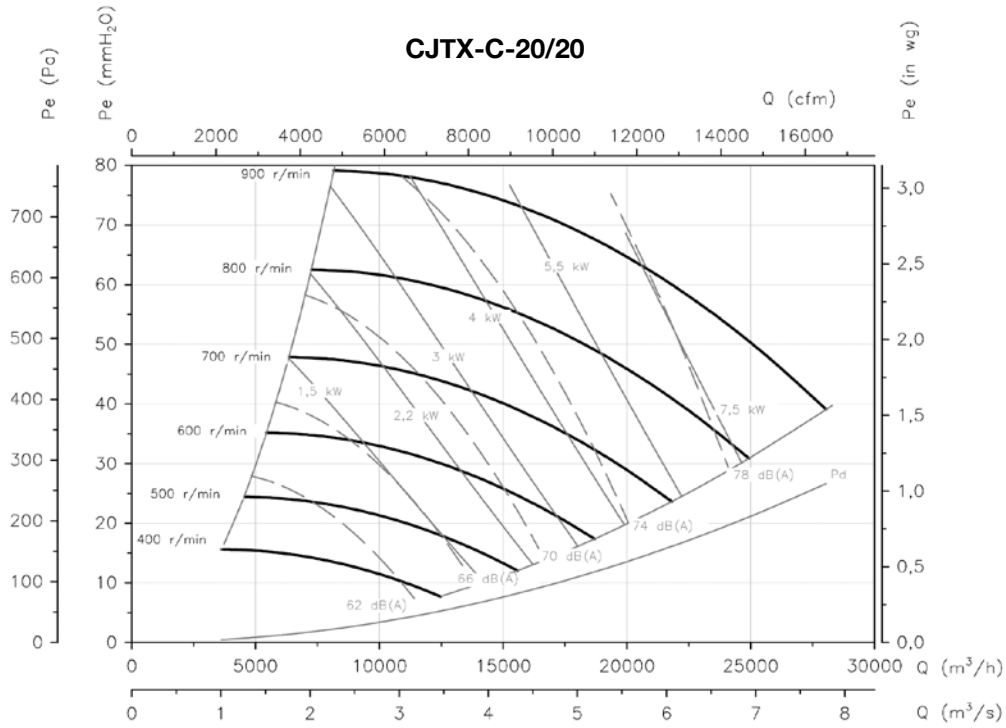

Characteristic curves

Q= Flow rate in m³/h, m³/s and cfm

Pe= Static pressure in mm H₂O, Pa and inwg

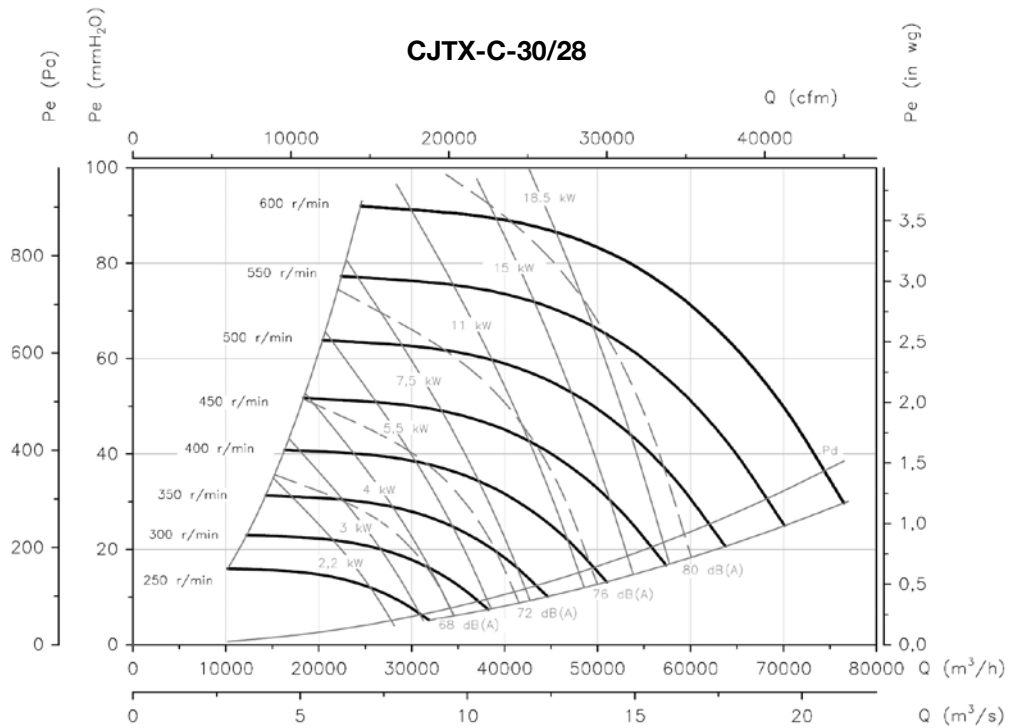
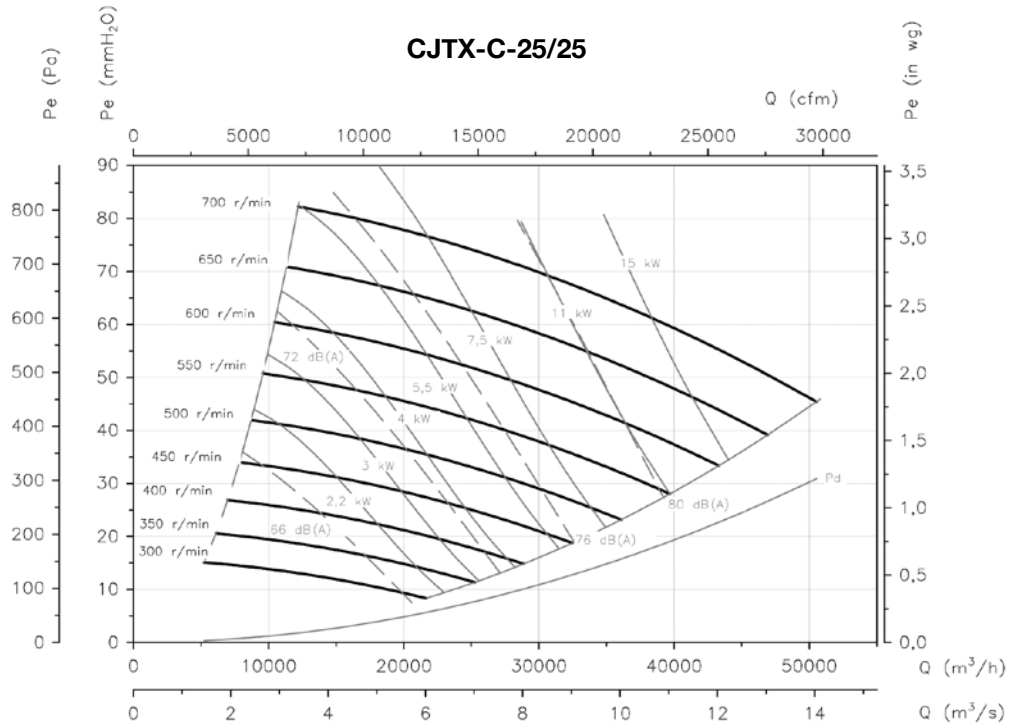

CJSX

400 °C/2h belt-driven single inlet extractor fan units



400 °C/2h extractor fan units, with motor mounted outside the airflow path. For outdoor operation in fire risk zones.

Fan:

- Galvanised sheet steel structure.
- Forward curved impeller in galvanized sheet steel.
- Approved in accordance with standard EN 12101-3, with certificate no.: 0370-CPR-0503.

Motor:

- Class F motors with ball bearings and IP55 protection.
- Motors with IE3 efficiency for powers equal to or greater than 0.75 kW, except single-phase, 2-speed and 8-pole.

- Three-phase 230/400 V 50 Hz (up to 4 kW) and 400/690 V 50 Hz (powers greater than 4 kW).
- Maximum temperature of air to be carried: S1 continuous operation -25 °C +120 °C. S2 operation, 300 °C/2h and 400 °C/2h.

Finish:

- Anti-corrosive in galvanized steel sheet.

On request:

- Fans with 2 speed motor.
- Fans with vertical outlet.

Order code

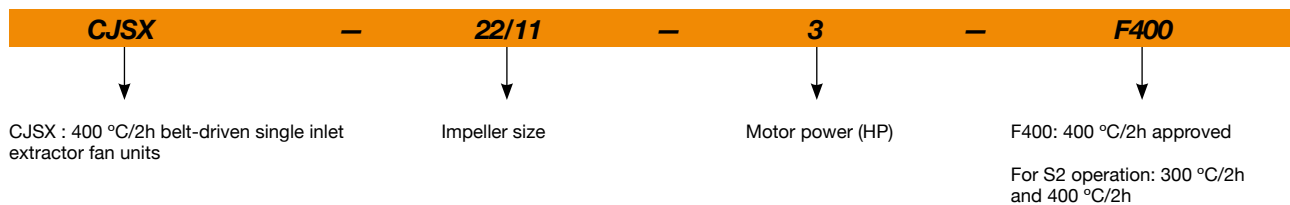

Technical characteristics

Model	Speed (r/min)	Maximum admissible current (A)			Installed power (kW)	Maximum flow rate (m³/h)	Sound pressure level dB (A)	Approx. weight (Kg)
		230V	400V	690V				
CJSX-12/6-0.75	1000	2.92	1.69		0.55	2600	68	73
CJSX-12/6-1 IE3	1100	2.82	1.62		0.75	3100	72	74
CJSX-12/6-1.5 IE3	1250	4.07	2.34		1.10	3500	75	77
CJSX-12/6-2 IE3	1300	5.41	3.11		1.50	4250	76	80
CJSX-12/6-3 IE3	1500	7.93	4.56		2.20	4800	79	85
CJSX-15/7-1 IE3	800	2.82	1.62		0.75	4000	66	92
CJSX-15/7-1.5 IE3	850	4.07	2.34		1.10	4800	69	95
CJSX-15/7-2 IE3	920	5.41	3.11		1.50	5400	71	98
CJSX-15/7-3 IE3	1000	7.93	4.56		2.20	6400	74	103
CJSX-15/7-4 IE3	1050	10.70	6.15		3.00	7400	76	106
CJSX-18/9-1.5 IE3	750	4.07	2.34		1.10	5800	68	111
CJSX-18/9-2 IE3	790	5.41	3.11		1.50	6600	70	114
CJSX-18/9-3 IE3	800	7.93	4.56		2.20	8200	73	119
CJSX-18/9-4 IE3	850	10.70	6.15		3.00	9000	76	122

Technical characteristics

Model	Speed (r/min)	Maximum admissible current (A)			Installed power (kW)	Maximum flow rate (m³/h)	Sound pressure level dB (A)	Approx. weight (Kg)
		230V	400V	690V				
CJSX-18/9-5.5 IE3	920	13.90	8.00		4.00	10500	80	125
CJSX-20/10-2 IE3	650	5.41	3.11		1.50	8100	66	203
CJSX-20/10-3 IE3	690	7.93	4.56		2.20	10100	69	208
CJSX-20/10-4 IE3	750	10.70	6.15		3.00	11500	72	211
CJSX-20/10-5.5 IE3	790	13.90	8.00		4.00	13100	73	214
CJSX-20/10-7.5 IE3	850		10.30	5.97	5.50	15000	75	227
CJSX-22/11-3 IE3	580	7.93	4.56		2.20	11200	67	219
CJSX-22/11-4 IE3	610	10.70	6.15		3.00	13000	69	222
CJSX-22/11-5.5 IE3	650	13.90	8.00		4.00	15000	71	225
CJSX-22/11-7.5 IE3	690		10.30	5.97	5.50	17000	73	238
CJSX-22/11-10 IE3	750		13.90	8.06	7.50	19000	75	246
CJSX-22/11-15 IE3	830		20.90	12.10	11.00	22000	77	273
CJSX-22/11-20 IE3	910		27.90	16.20	15.00	24500	79	292
CJSX-22/11-25 IE3	1000		35.10	20.30	18.50	26000	81	322
CJSX-25/13-4 IE3	520	10.70	6.15		3.00	14000	61	254
CJSX-25/13-5.5 IE3	550	13.90	8.00		4.00	17000	64	257
CJSX-25/13-7.5 IE3	590		10.30	5.97	5.50	19500	68	270
CJSX-25/13-10 IE3	620		13.90	8.06	7.50	23000	70	278
CJSX-25/13-15 IE3	690		20.90	12.10	11.00	26500	72	305
CJSX-25/13-20 IE3	750		27.90	16.20	15.00	29500	74	324
CJSX-25/13-25 IE3	810		35.10	20.30	18.50	32000	76	354
CJSX-30/14-5.5 IE3	400	13.90	8.00		4.00	21000	69	331
CJSX-30/14-7.5 IE3	425		10.30	5.97	5.50	24000	72	344
CJSX-30/14-10 IE3	460		13.90	8.06	7.50	27500	75	352
CJSX-30/14-15 IE3	500		20.90	12.10	11.00	33000	77	379
CJSX-30/14-20 IE3	550		27.90	16.20	15.00	36500	79	398
CJSX-30/14-25 IE3	600		35.10	20.30	18.50	38000	80	428



Erp. (Energy Related Products)

Information on Directive 2009/125/EC can be downloaded from the SODECA website or the QuickFan selector programme.

Accessories

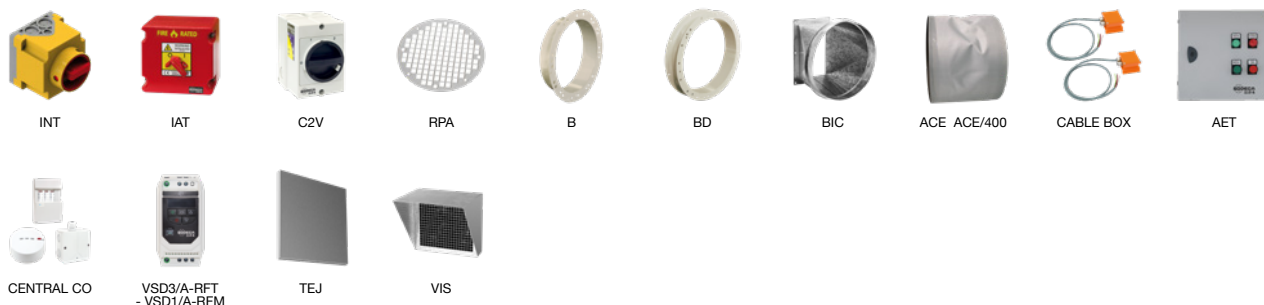

Dimensions mm

Standard supply horizontal impulsion (H) RD 90

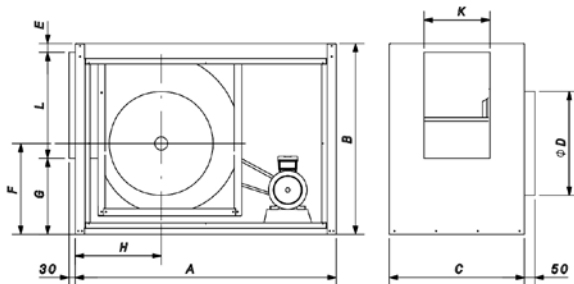

Horizontal impulsion on request (H) LG 90

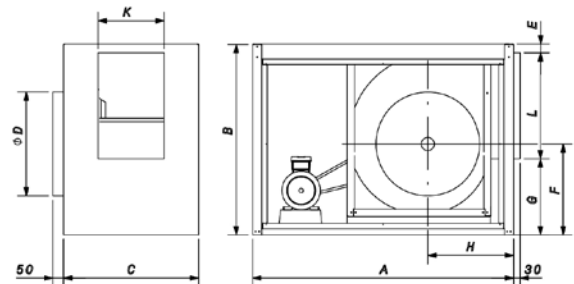

	A	B	C	ØD	E	F	G	H	K	L
CJSX-12/6-H	853	653	543	317	44	315	262	306	215	347
CJSX-15/7-H	1003	758	600	400	49	357	299	337	273	410
CJSX-18/9-H	1203	878	621	480	42	418	348	396	304	488
CJSX-20/10-H	1426	1105	729	582	91	491	407	429	334	607
CJSX-22/11-H	1573	1253	763	625	61	540	492	458	362	700
CJSX-25/13-H	1653	1286	821	703	62	579	425	479	416	799
CJSX-30/14-H	1868	1521	860	804	54	699	528	575	478	939

Vertical impulsion on request (V) RD 0

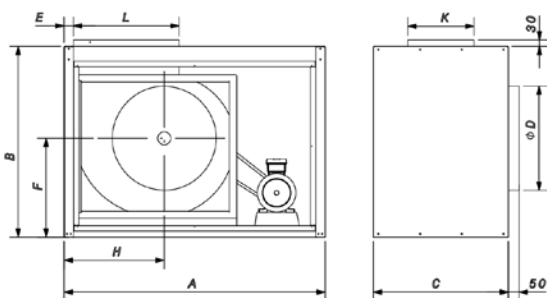

Vertical impulsion on request (V) LG 0

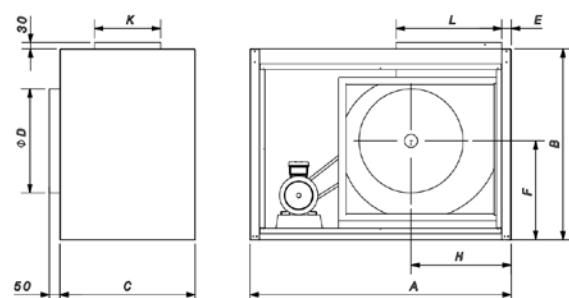

	A	B	C	ØD	E	F	H	K	L
CJSX-12/6-V	853	653	543	317	45	348	339	215	347
CJSX-15/7-V	1003	758	600	400	27	398	379	273	410
CJSX-18/9-V	1203	878	621	480	43	455	462	304	488
CJSX-20/10-V	1426	1105	729	582	91	555	615	334	607
CJSX-22/11-V	1573	1253	763	625	61	614	633	362	700
CJSX-25/13-V	1653	1286	821	703	62	700	707	416	799
CJSX-30/14-V	1868	1521	860	804	65	788	843	478	939

Characteristic curves

Q= Flow rate in m³/h, m³/s and cfm

Pe= Static pressure in mm H₂O, Pa and inwg

CJSX-12/6

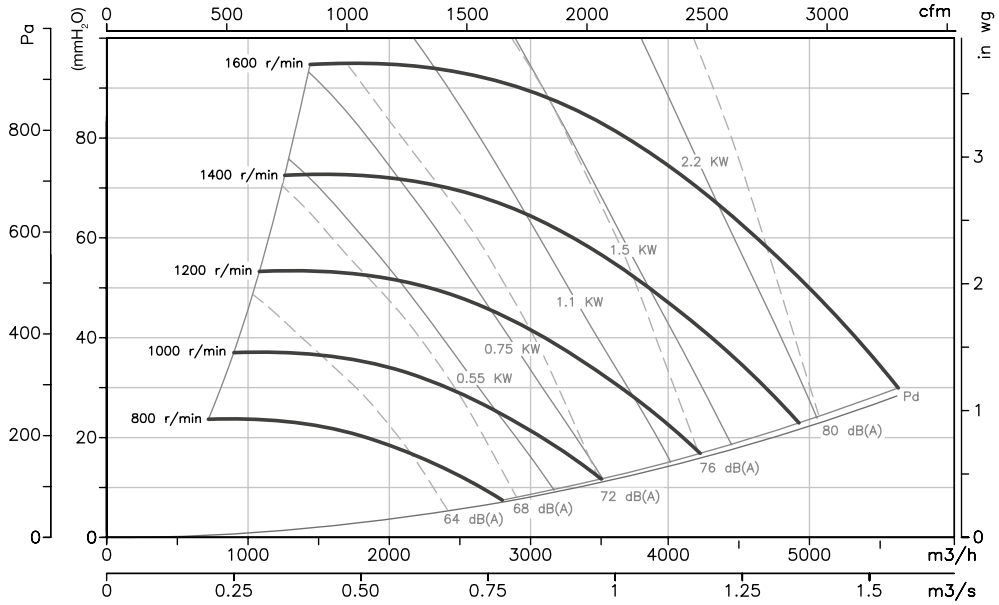

CJSX-15/7

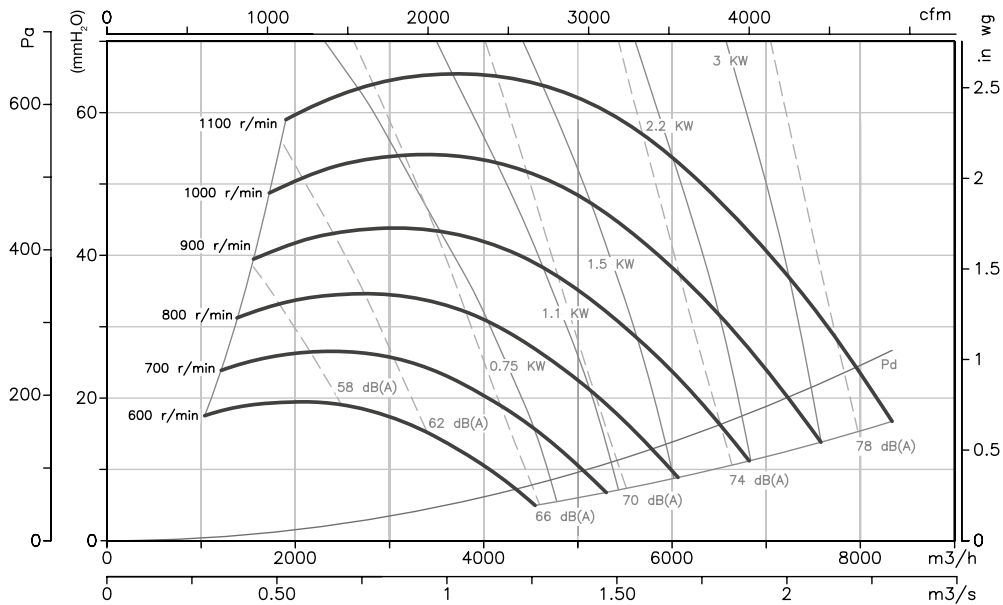

Characteristic curves

Q= Flow rate in m³/h, m³/s and cfm

Pe= Static pressure in mm H₂O, Pa and inwg

CJSX-18/9

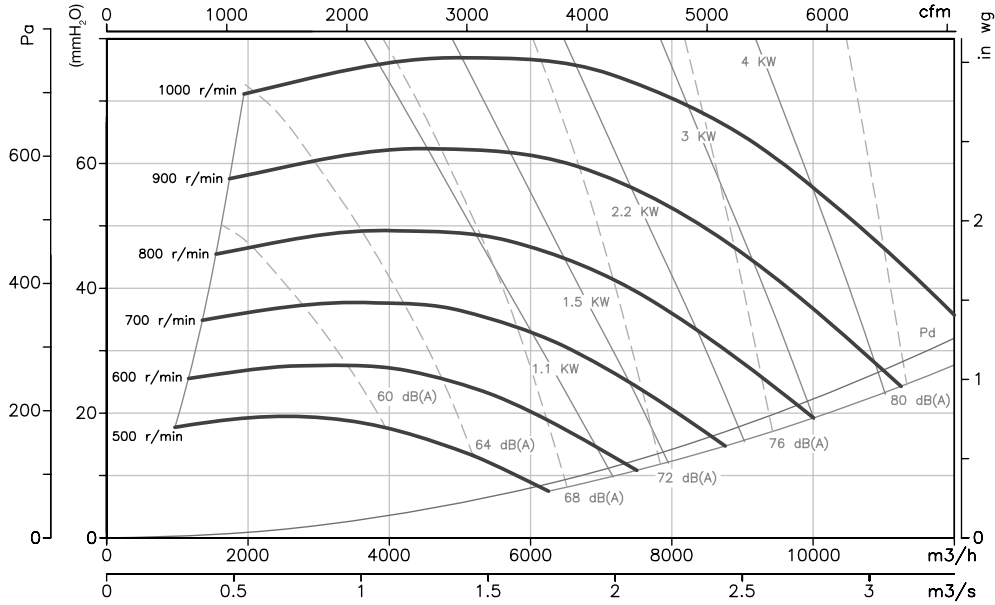

CJSX-20/10

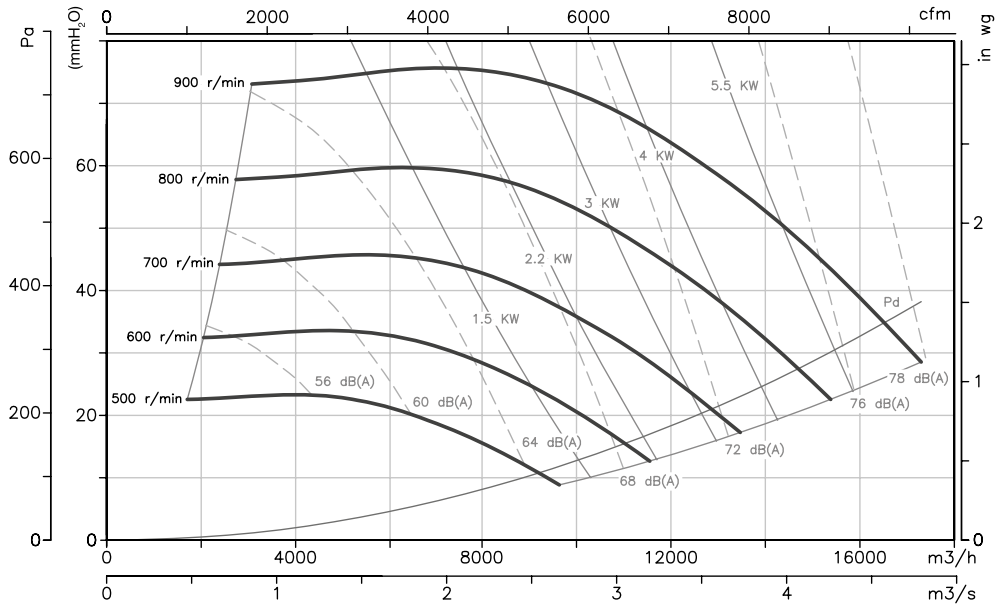

Characteristic curves

Q= Flow rate in m³/h, m³/s and cfm

Pe= Static pressure in mm H₂O, Pa and inwg

CJSX-22/11

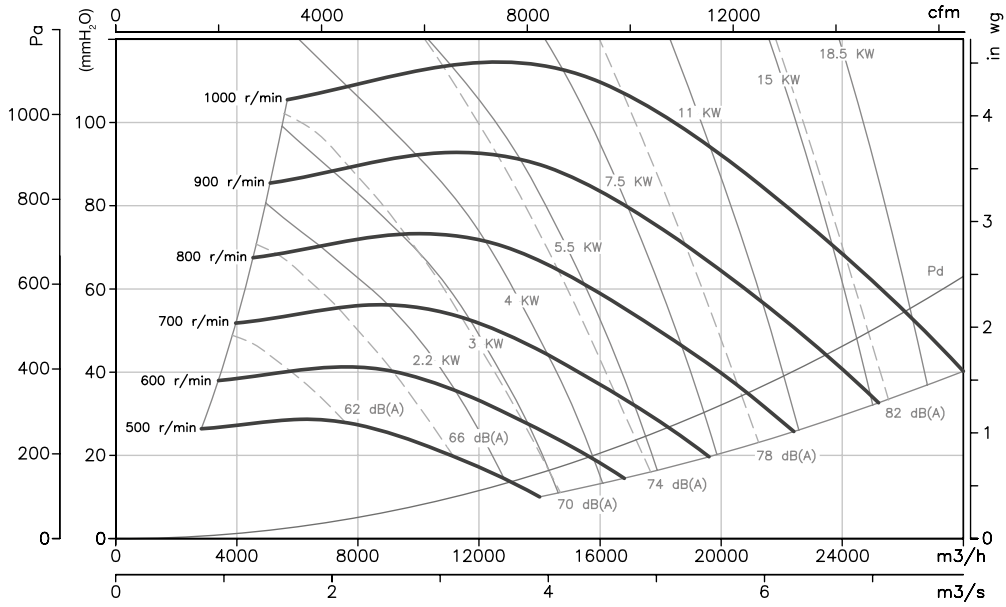

CJSX-25/13

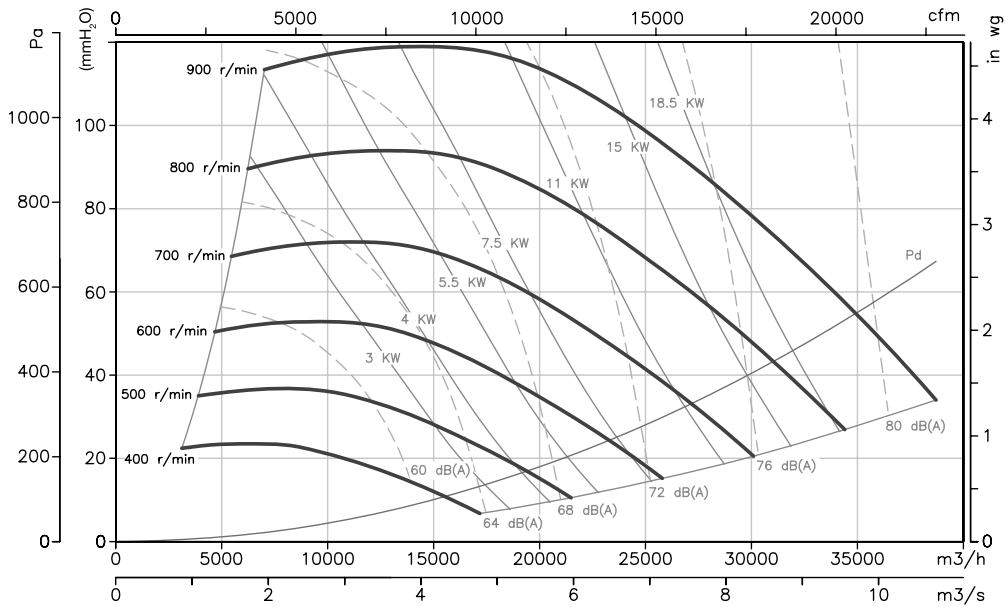

Characteristic curves

Q= Flow rate in m³/h, m³/s and cfm

Pe= Static pressure in mm H₂O, Pa and inwg

CJSX-30/14

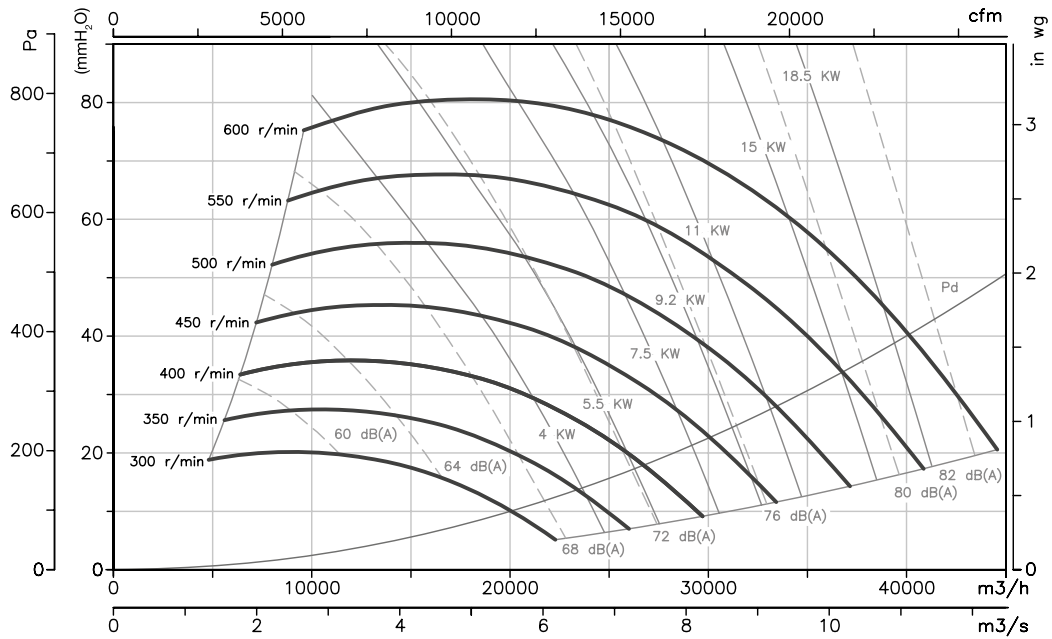

CJSRX

Extraction units 400 °C/2h to work outside the fire risk zone, driven by transmission with a backward curved impeller



Belt driven 400 °C/2h extractor fan units with backward curved impeller fitted with electric motors and a standardised set of pulleys, belts and guards in accordance with standard ISO-13857.

Fan:

- Sheet steel casing.
- Backward curved impeller made of sheet steel.
- Approved in accordance with standard EN 12101-3, with certificate no.: 0370-CPR-1578.
- Standardised set of pulleys, belts and guards in accordance with standard ISO-13857.
- Maximum temperature of air to be carried: -25 °C +150 °C.

Motor:

- Motors with IE3 efficiency for powers equal to or greater than 0.75 kW, except single-phase, 2-speed and 8-pole.
- Class F motors with ball bearings and IP55 protection.
- Three-phase 230/400 V 50 Hz (up to 4 kW) and 400/690 V 50 Hz (powers greater than 4 kW).
- Working temperature: -25 °C +50 °C.

Finish:

- Anti-corrosive in galvanized steel sheet.

On request:

- Special windings for different voltages.

Order code



Technical characteristics

Model	Speed (r/min)	Maximum admissible current (A)			Installed power (kW)	Maximum flow rate (m ³ /h)	Sound pressure level dB (A)	Approx. weight (Kg)
		230V	400V	690V				
CJSRX-315-1 IE3	2095	2.82	1.62		0.75	3430	64	111
CJSRX-315-1.5 IE3	2375	4.07	2.34		1.10	3880	68	119
CJSRX-315-2 IE3	2655	5.41	3.11		1.50	4340	70	124
CJSRX-315-3 IE3	3000	7.93	4.56		2.20	4910	73	129
CJSRX-355-0.75	1580	2.92	1.69		0.55	3680	63	126
CJSRX-355-1 IE3	1765	2.82	1.62		0.75	4120	67	127
CJSRX-355-1.5 IE3	2010	4.07	2.34		1.10	4690	70	135
CJSRX-355-2 IE3	2225	5.41	3.11		1.50	5190	73	140
CJSRX-355-3 IE3	2530	7.93	4.56		2.20	5900	75	144
CJSRX-355-4 IE3	2860	10.70	6.15		3.00	6680	78	150
CJSRX-400-1 IE3	1465	2.82	1.62		0.75	4860	61	155
CJSRX-400-1.5 IE3	1665	4.07	2.34		1.10	5520	65	160
CJSRX-400-2 IE3	1845	5.41	3.11		1.50	6110	67	171
CJSRX-400-3 IE3	2100	7.93	4.56		2.20	6960	70	172
CJSRX-400-4 IE3	2370	10.70	6.15		3.00	7850	73	174
CJSRX-400-5.5 IE3	2610	13.90	8.00		4.00	8640	75	181
CJSRX-450-1 IE3	1220	2.82	1.62		0.75	5620	63	186

Technical characteristics

Model	Speed (r/min)	Maximum admissible current (A)			Installed power (kW)	Maximum flow rate (m³/h)	Sound pressure level dB (A)	Approx. weight (Kg)
		230V	400V	690V				
CJSRX-450-1.5 IE3	1390	4.07	2.34		1.10	6400	68	189
CJSRX-450-2 IE3	1540	5.41	3.11		1.50	7100	70	200
CJSRX-450-3 IE3	1750	7.93	4.56		2.20	8060	73	201
CJSRX-450-4 IE3	1980	10.70	6.15		3.00	9120	76	203
CJSRX-450-5.5 IE3	2180	13.90	8.00		4.00	10040	78	210
CJSRX-450-7.5 IE3	2420		10.30	5.97	5.50	11150	80	253
CJSRX-450-10 IE3	2670		13.90	8.06	7.50	12300	82	229
CJSRX-500-1.5 IE3	1140	4.07	2.34		1.10	7330	66	228
CJSRX-500-2 IE3	1270	5.41	3.11		1.50	8160	70	238
CJSRX-500-3 IE3	1445	7.93	4.56		2.20	9290	75	240
CJSRX-500-4 IE3	1635	10.70	6.15		3.00	10510	77	246
CJSRX-500-5.5 IE3	1800	13.90	8.00		4.00	11570	79	252
CJSRX-500-7.5 IE3	2000		10.30	5.97	5.50	12860	82	291
CJSRX-500-10 IE3	2220		13.90	8.06	7.50	14270	84	267
CJSRX-500-15 IE3	2300		20.90	12.10	11.00	14780	85	321
CJSRX-560-2 IE3	1035	5.41	3.11		1.50	9880	63	304
CJSRX-560-3 IE3	1185	7.93	4.56		2.20	11360	68	299
CJSRX-560-4 IE3	1340	10.70	6.15		3.00	12880	71	306
CJSRX-560-5.5 IE3	1475	13.90	8.00		4.00	14210	74	312
CJSRX-560-7.5 IE3	1640		10.30	5.97	5.50	15830	76	351
CJSRX-560-10 IE3	1815		13.90	8.06	7.50	17560	78	327
CJSRX-560-15 IE3	2065		20.90	12.10	11.00	20010	81	381
CJSRX-630-3 IE3	1010	7.93	4.56		2.20	12120	66	339
CJSRX-630-4 IE3	1140	10.70	6.15		3.00	13680	69	345
CJSRX-630-5.5 IE3	1255	13.90	8.00		4.00	15060	71	351
CJSRX-630-7.5 IE3	1395		10.30	5.97	5.50	16740	73	390
CJSRX-630-10 IE3	1550		13.90	8.06	7.50	18600	76	366
CJSRX-630-15 IE3	1760		20.90	12.10	11.00	21120	78	420
CJSRX-630-20 IE3	1900		27.90	16.20	15.00	22800	80	442
CJSRX-710-4 IE3	960	10.70	6.15		3.00	17060	66	416
CJSRX-710-5.5 IE3	1060	13.90	8.00		4.00	18840	69	422
CJSRX-710-7.5 IE3	1180		10.30	5.97	5.50	20980	71	461
CJSRX-710-10 IE3	1305		13.90	8.06	7.50	23200	73	456
CJSRX-710-15 IE3	1485		20.90	12.10	11.00	26400	76	491
CJSRX-710-20 IE3	1670		27.90	16.20	15.00	29690	78	513
CJSRX-710-25 IE3	1750		35.10	20.30	18.50	31110	79	546



Erp. (Energy Related Products)

Information on Directive 2009/125/EC can be downloaded from the SODECA website or the QuickFan selector programme.

Accessories



INT



IAT



C2V



RPA



B



BD



BIC



ACE ACE/400



CABLE BOX



AET



CENTRAL CO



VSD3/A-RFT
- VSD1/A-RFM

Dimensions mm

Standard supply horizontal impulsion
(H) RD 90

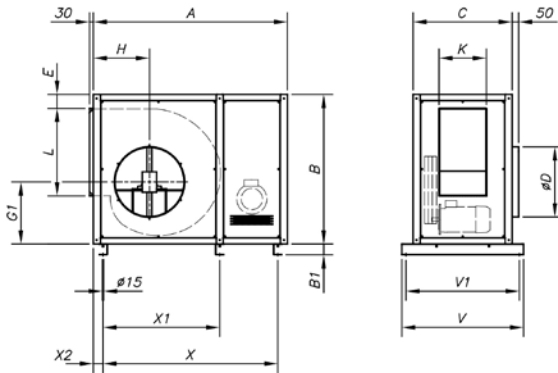

Horizontal impulsion on request
(H) LG 90

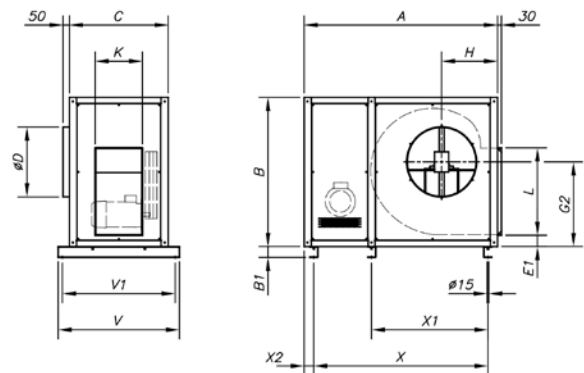

Vertical impulsion on request
(V) RD 0

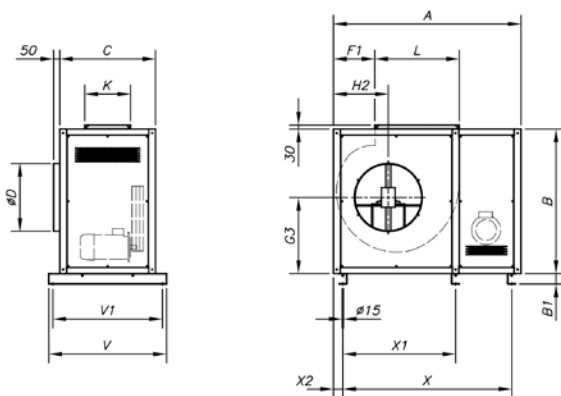

Vertical impulsion on request
(V) LG 0

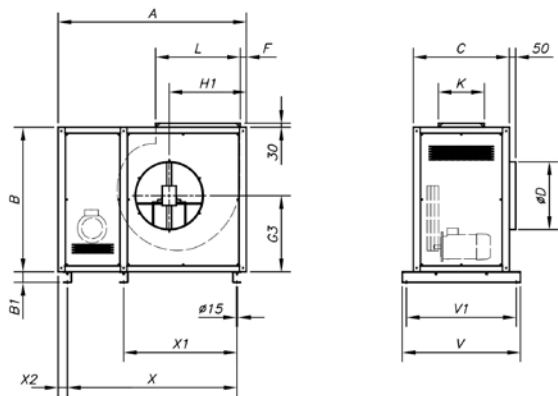

	A	B	B1	C	ØD	E	E1	F	F1	G1	G2	G3
CJSRX-315	1170	740	60	600	315	82	84.2	113	281	317.5	423.2	366.2
CJSRX-355	1265	815	60	650	365	85	86.5	112.5	302.5	347.2	470	398
CJSRX-400	1370	900	60	680	400	82	90.2	111	331	386.2	522.2	447.2
CJSRX-450	1480	990	60	716	448	82	91.2	112.8	360	422.2	577.2	491
CJSRX-500	1625	1080	60	760	510	80.5	91	111.7	381.3	461.2	629.2	534.2
CJSRX-560	1760	1195	60	810	580	86.8	94.2	128	426	506.2	696.2	590
CJSRX-630	1880	1322	60	850	635	85.2	89.6	113.4	455.6	557.7	768.7	648.2
CJSRX-710	2180	1500	80	910	710	103	108.2	100	491	632.2	873.2	737.2

	H	H1	H2	K	L	V	V1	X	X1	X2
CJSRX-315	305	451.5	346.3	224	405	760	680	880	-	155
CJSRX-355	338	496	373	248	454	810	730	1020	-	152
CJSRX-400	359	543	407	275	508	840	760	1120	-	152
CJSRX-450	383	598	443	309	570	876	796	1240	-	152
CJSRX-500	409	650	482	345	639	920	840	1340	670	152
CJSRX-560	462	731	540	384	716	970	890	1490	745	152
CJSRX-630	488	792.5	578.5	433	802	1010	930	1610	820	158
CJSRX-710	562	865	624	479	899	1070	990	1910	955	168

Characteristic curves

Q= Flow rate in m³/h, m³/s and cfm

Pe= Static pressure in mm H₂O, Pa and inwg

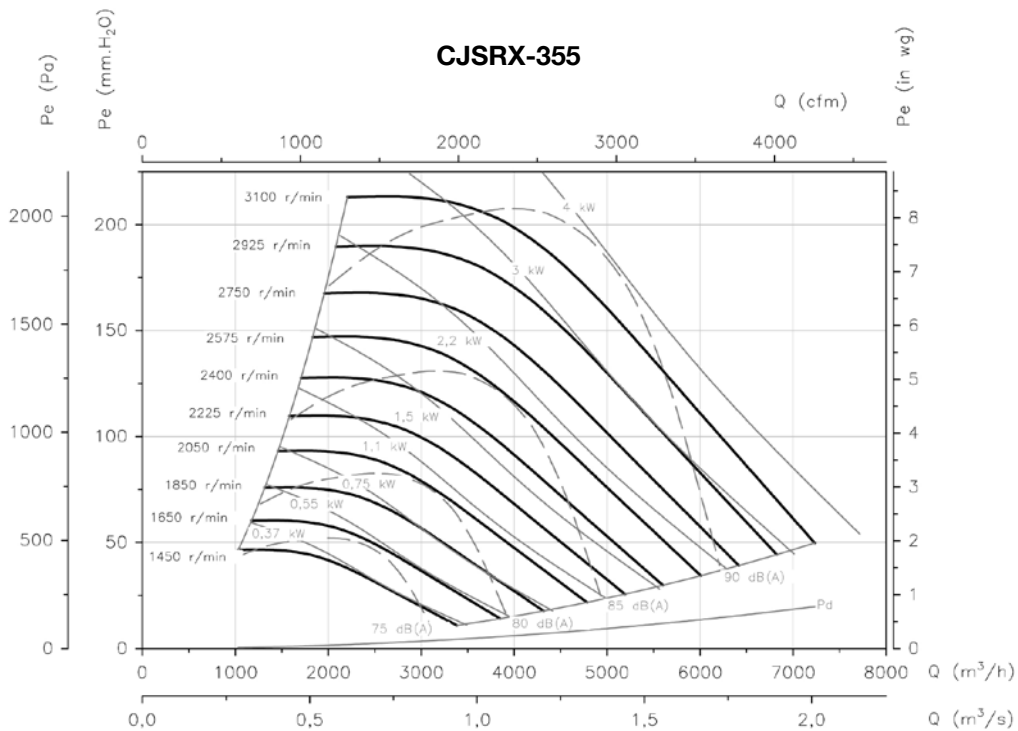
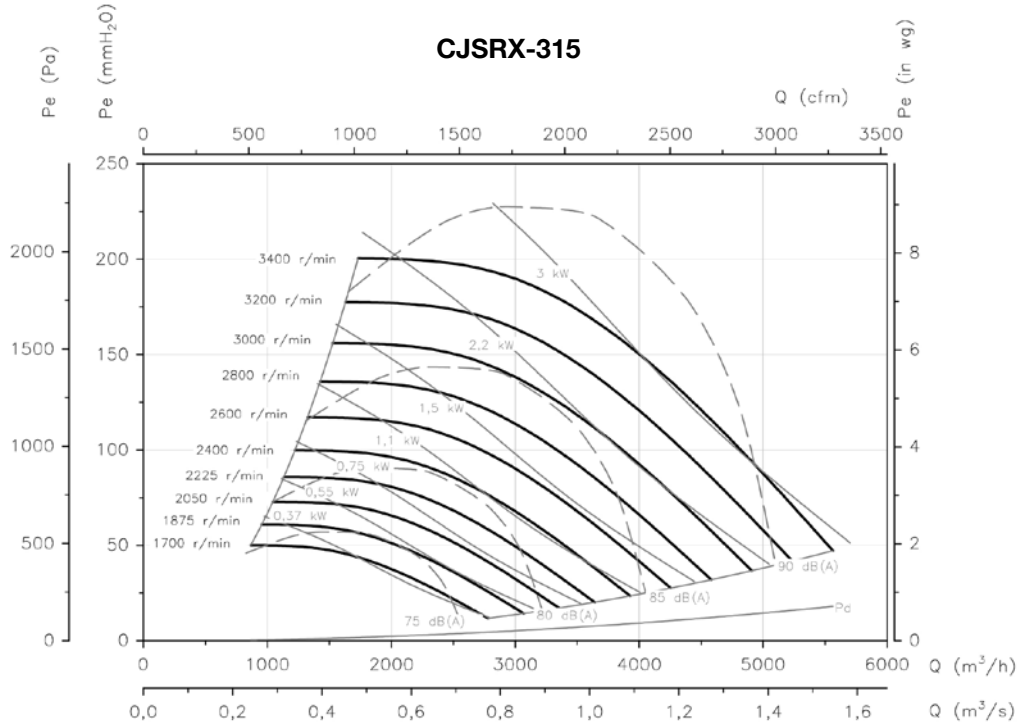

Characteristic curves

Q= Flow rate in m³/h, m³/s and cfm

Pe= Static pressure in mm H₂O, Pa and inwg

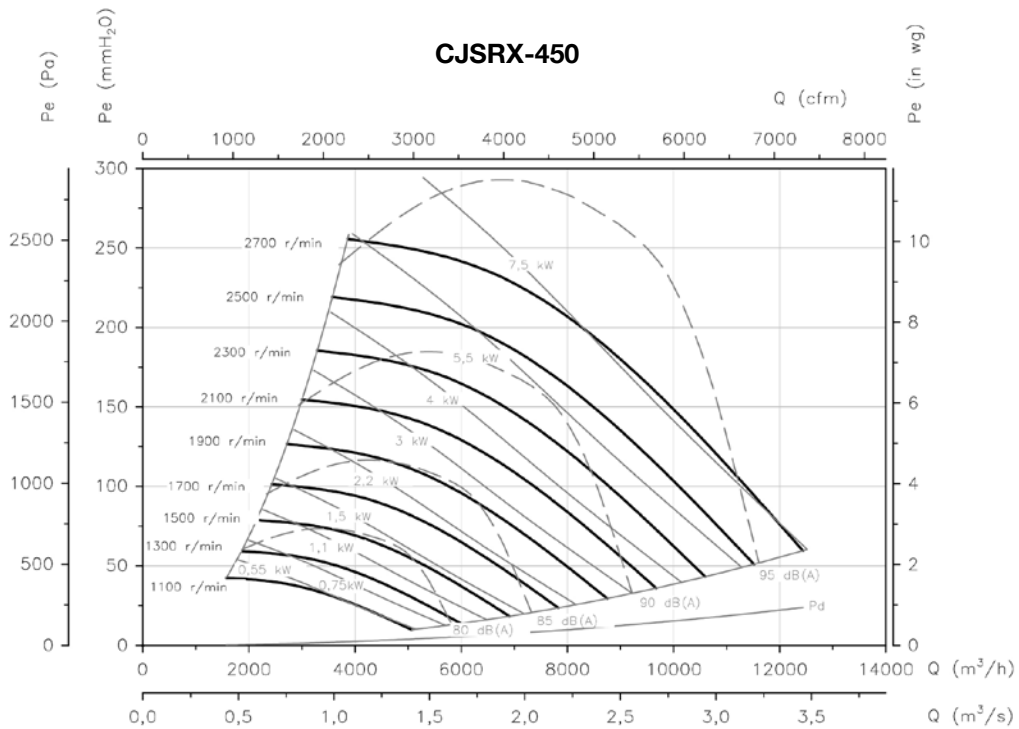
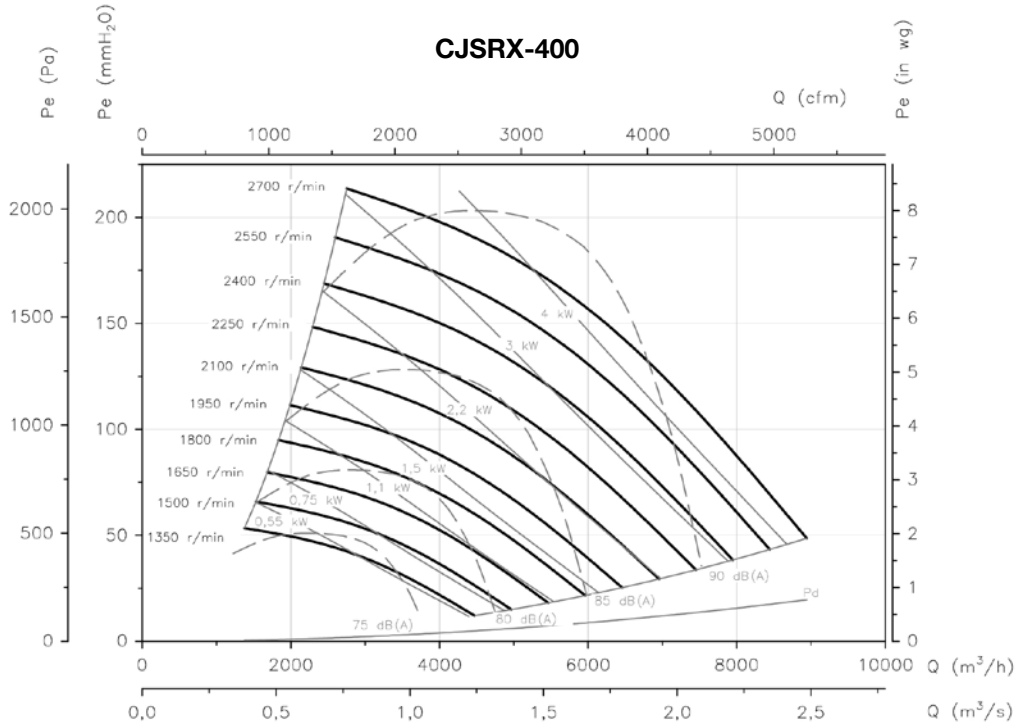

Characteristic curves

Q= Flow rate in m³/h, m³/s and cfm

Pe= Static pressure in mm H₂O, Pa and inwg

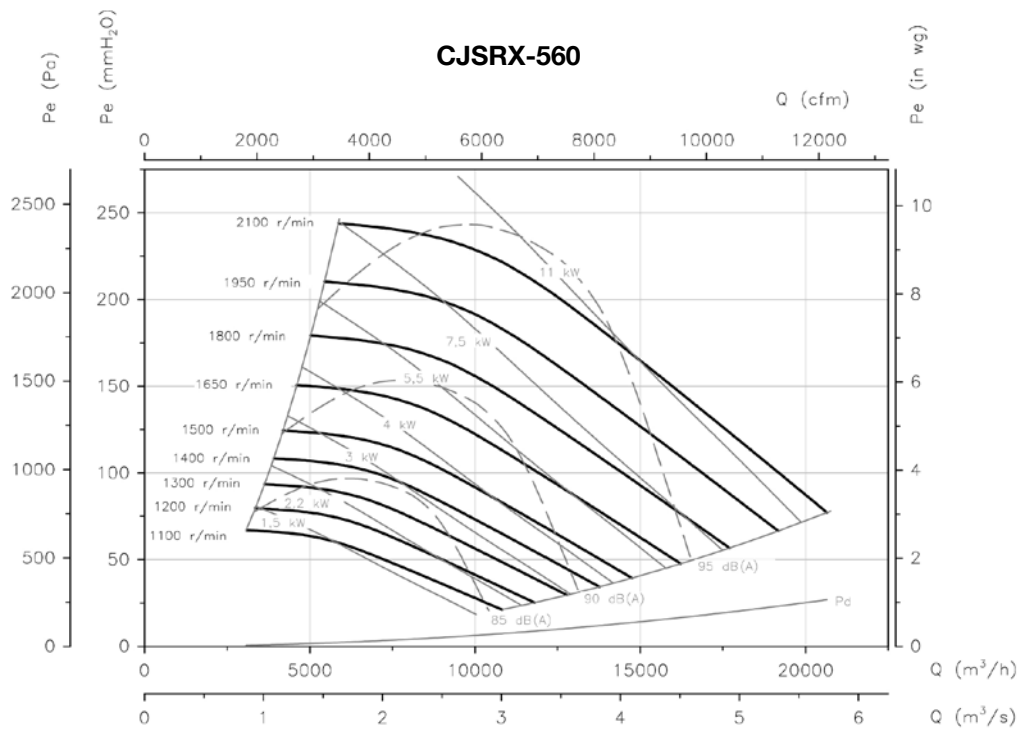
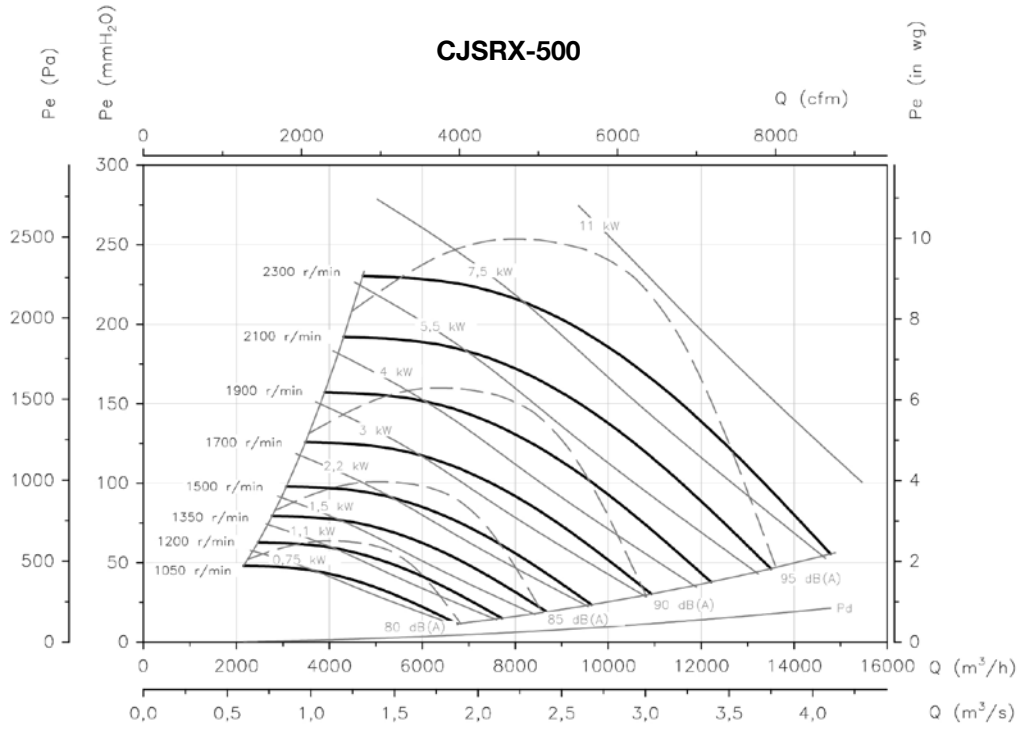

Characteristic curves

Q= Flow rate in m³/h, m³/s and cfm

Pe= Static pressure in mm H₂O, Pa and inwg

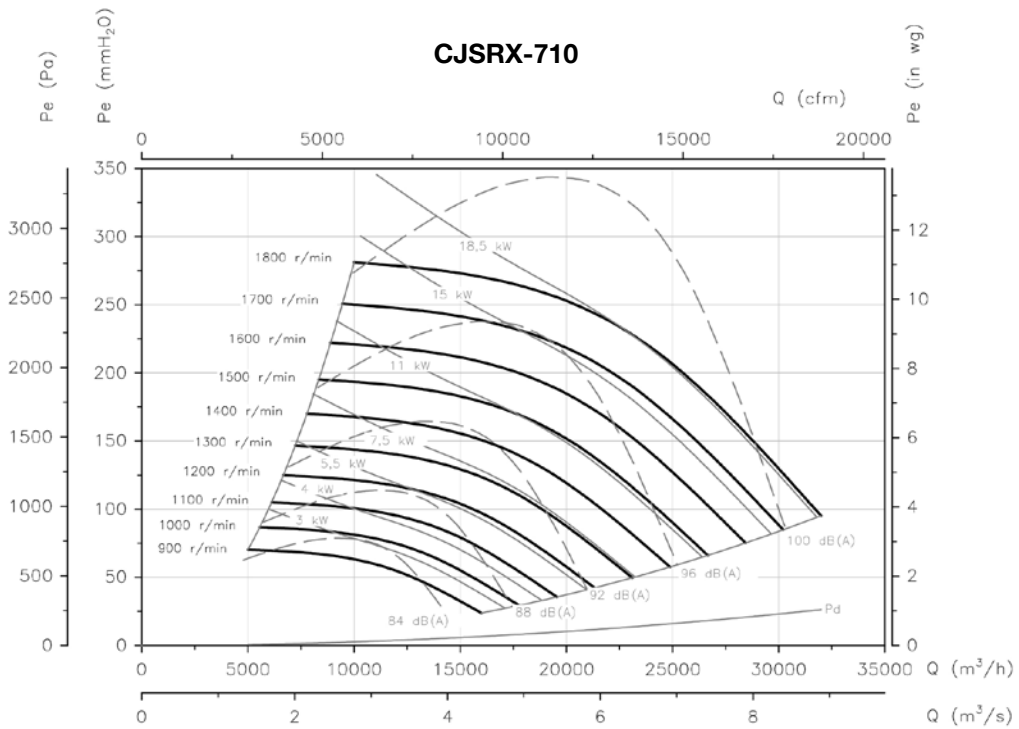
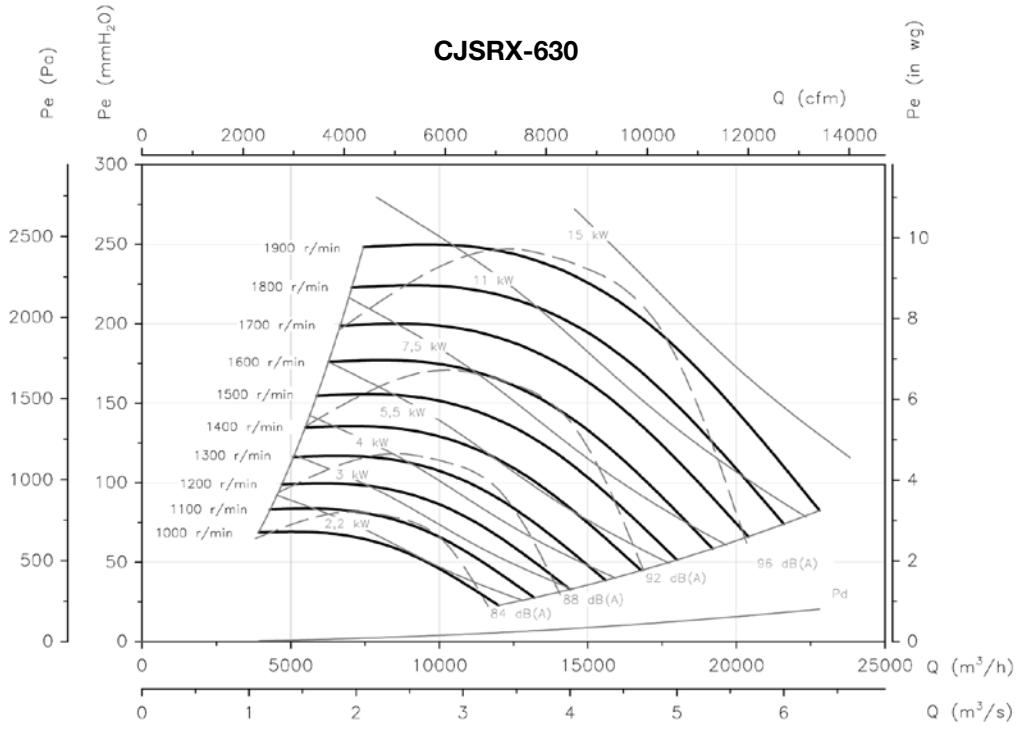

CJLINE

400 °C/2h air and smoke extract fan units with linear inlets and outlets



400 °C/2h and 120 °C continuous operation in-line extract fans units for outdoor operation in fire risk zones.

Fan:

- Galvanised sheet steel structure.
- Backward curved impeller made of sheet steel.
- Approved in accordance with standard EN 12101-3, with certificate no.: 0370-CPR-0594.
- Linear airflow direction.

Motor:

- Class F motors with ball bearings, IP55 protection and with 1 or 2 speeds, depending on model.
- Motors with IE3 efficiency for powers equal to or greater than 0,75 kW, except single-phase, 2-speed and 8-pole.

- Three-phase 230/400 V 50 Hz (up to 4 kW) and 400/690 V 50 Hz (powers greater than 4 kW).
- Maximum temperature of air to be carried: S1 continuous operation -20 °C +120 °C. S2 operation, 300 °C/2h and 400 °C/2h.

Finish:

- Anti-corrosive in galvanized steel sheet.

On request:

- Fans with 2 speed motor.

Order code

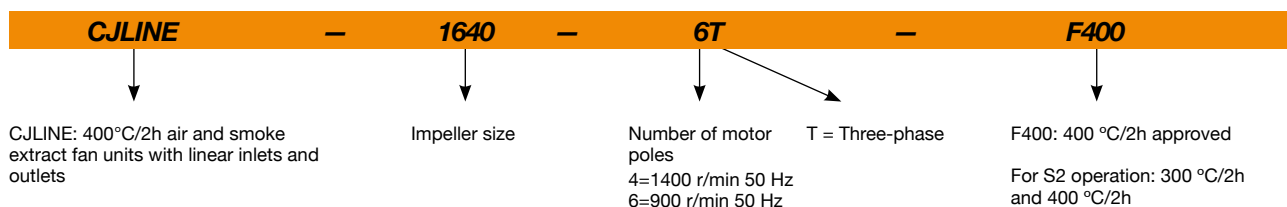

Technical characteristics

Model	Speed (r/min)	Maximum admissible current (A)			Installed power (kW)	Maximum flow rate (m³/h)	Sound pressure level dB (A)	Approx. weight (Kg)
		230V	400V	690V				
CJLINE-1131-4T	1350	1.66	0.96		0.25	2000	47	58
CJLINE-1235-4T	1350	1.66	0.96		0.25	2820	54	62
CJLINE-1640-4T	1380	2.92	1.69		0.55	4450	59	76
CJLINE/H-1650-4T IE3	1440	5.41	3.11		1.50	9860	72	118
CJLINE-1845-4T IE3	1455	4.07	2.34		1.10	6290	63	87
CJLINE-1845-6T	900	2.24	1.30		0.37	4280	55	81
CJLINE/H-1856-4T IE3	1440	10.70	6.15		3.00	13590	78	170
CJLINE-1856-6T IE3	940	3.36	1.93		0.75	8100	60	135
CJLINE/H-2063-4T IE3	1465		10.30	5.97	5.50	22010	81	260
CJLINE-2063-6T IE3	940	3.36	1.93		0.75	9860	63	188
CJLINE-2271-6T IE3	950	6.43	3.70		1.50	13600	67	209
CJLINE-2880-6T IE3	970	12.00	6.91		3.00	22400	69	275



Erp. (Energy Related Products)

Information on Directive 2009/125/EC can be downloaded from the SODECA website or the QuickFan selector programme.

Acoustic characteristics

The indicated values are determined by measuring the sound pressure level and sound power in dB(A) obtained in a free field at a distance equivalent to twice the size of the fan plus the impeller diameter, with a minimum of 1.5 m.

Sound power spectrum Lw(A) in dB(A) per Hz frequency band

	63	125	250	500	1000	2000	4000	8000		63	125	250	500	1000	2000	4000	8000
CJLINE-1131-4T	42	51	57	56	60	60	52	46	CJLINE/H-1856-4T	69	77	91	87	90	90	85	71
CJLINE-1235-4T	49	58	64	63	67	66	59	53	CJLINE-1856-6T	58	64	69	70	73	72	65	60
CJLINE-1640-4T	56	62	67	68	71	73	65	59	CJLINE/H-2063-4T	81	86	93	94	93	90	83	75
CJLINE/H-1650-4T	64	74	82	84	83	85	76	66	CJLINE-2063-6T	60	66	72	72	76	76	68	61
CJLINE-1845-4T	60	66	71	72	75	77	69	63	CJLINE-2271-6T	64	70	76	76	80	80	72	65
CJLINE-1845-6T	52	58	63	64	67	69	61	55	CJLINE-2880-6T	66	72	78	78	82	82	74	67

Dimensions mm

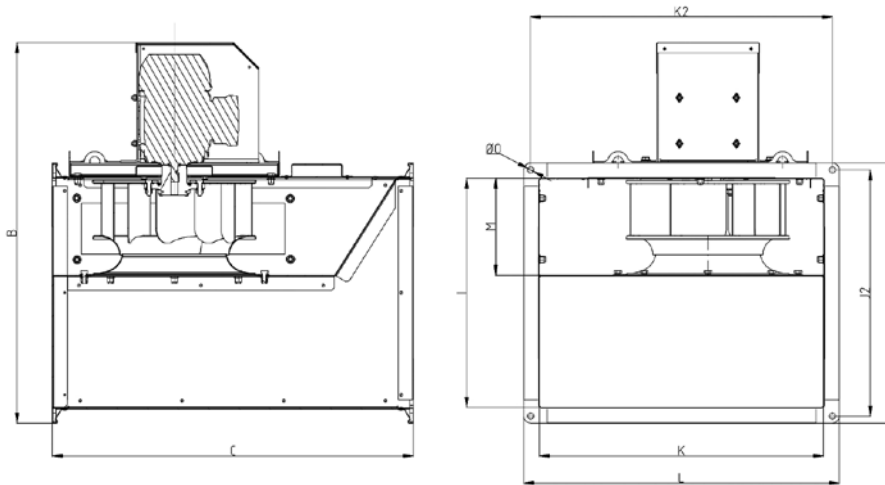

	B	C	I	J	J2	K	K2	L	M	ØO
CJLINE-1131	750	710	450	510	483	560	593	620	195	12
CJLINE-1235	797	800	500	560	533	620	653	680	223	12
CJLINE-1640	896	900	560	620	593	711	743	770	245	12
CJLINE/H-1650	1015	1000	630	690	663	800	833	860	338	12
CJLINE-1845	1015	1000	630	690	663	800	833	860	278	12
CJLINE-1856	1185	1250	800	860	833	1000	1033	1060	348	12
CJLINE/H-1856	1220	1250	800	860	833	1000	1033	1060	348	12
CJLINE-2063	1295	1400	900	980	940	1125	1165	1205	410	14
CJLINE/H-2063	1480	1400	900	980	940	1125	1165	1205	410	14
CJLINE-2271	1350	1400	900	980	940	1190	1230	1270	470	14
CJLINE-2880	1580	1500	1000	1080	1040	1250	1290	1330	510	14

Characteristic curves

Q= Flow rate in m³/h, m³/s and cfm

Pe= Static pressure in mm H₂O, Pa and inwg

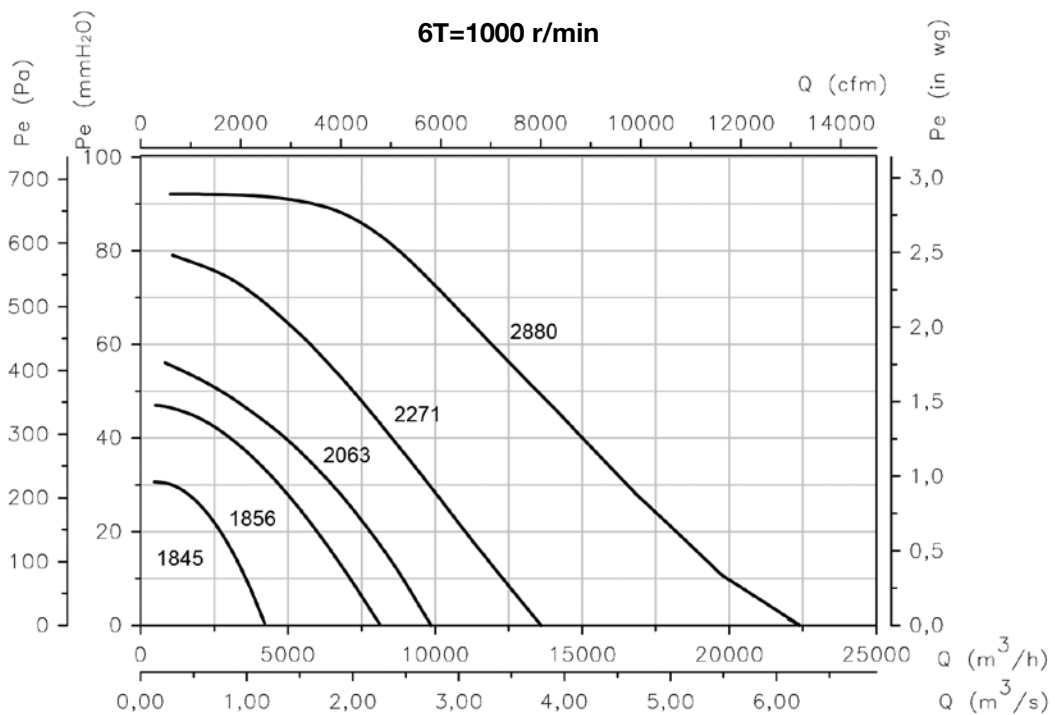
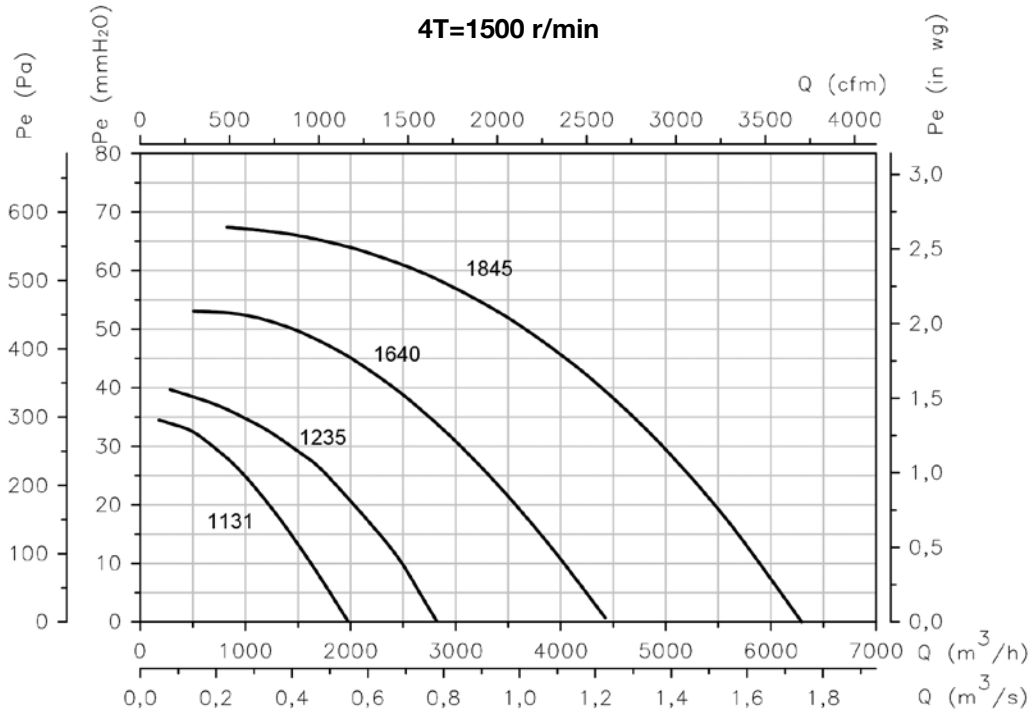

Characteristic curves

Q= Flow rate in m³/h, m³/s and cfm

Pe= Static pressure in mm H₂O, Pa and inwg

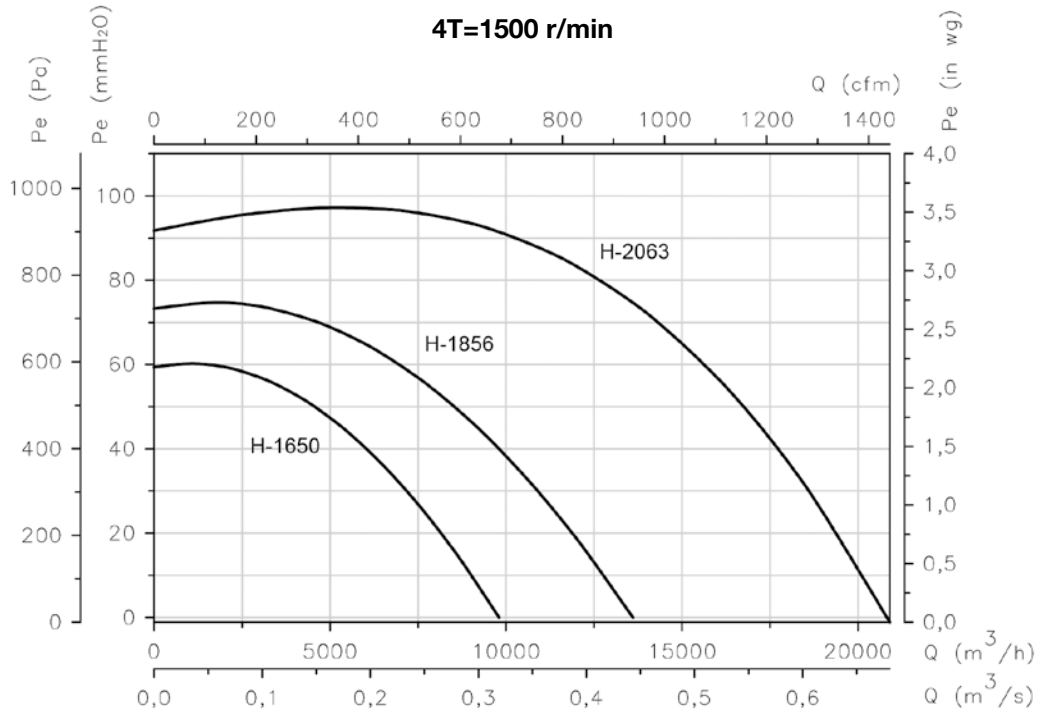

Accessories



INT



CABLE BOX



C2V



VSD3/A-RFT
- VSD1/A-RFM



CENTRAL CO



AET



VIS



TAC

CJLINE/EC

Air extract units with linear inlet and outlet, equipped with EC Technology IE5 motor



Air extraction units with linear inlet and outlet, equipped with EC Technology IE5 motor with integrated electronics.

Fan:

- Galvanised sheet steel structure.
- Backward curved impeller made of sheet steel.
- Linear airflow direction.

Motor:

- High efficiency EC Technology motors with integrated electronics, regulated by 0-10 V or 4-20 mA.
- IE5 efficiency motors, class F and IP55 protection.
- Single-phase 230 V 50/60 Hz.
- Working temperature: -25 °C +60 °C.

EC CONTROL: Supplied as an optional accessory. Control panel for ventilation systems with EC Technology motors with the electronics integrated in the motor itself. With the following characteristics:

- CPC: Constant pressure control.
- CFC: Constant flow control.
- DAY / NIGHT: Double pressure setpoint adjustment according to time of day.
- External sensor: compatible with temperature, humidity, air quality or CO sensor.
- Equipment preconfigured in constant pressure mode with 100 Pa set point.

Finish:

- Anti-corrosive in galvanized steel sheet.



← EC TECHNOLOGY MOTOR with integrated electronics



← EC CONTROL Supplied as an optional accessory

Order code

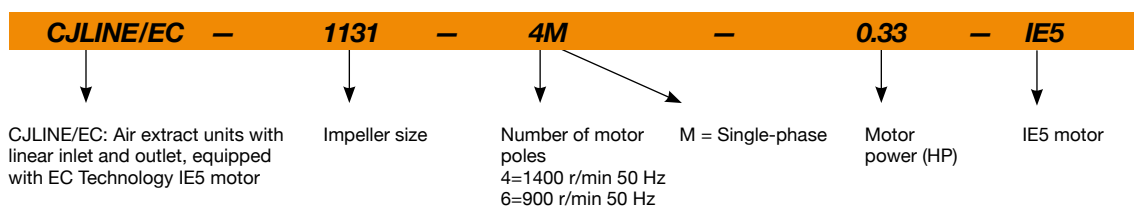

Technical characteristics

Model	Speed	Maximum admissible current (A)	Max. electric power (kW)	Maximum flow rate (m ³ /h)	Sound pressure level dB (A)	Approx. weight (Kg)
	(r/min)					
CJLINE/EC-1131-4M-0.33 IE5	1370	2.3	0.25	1980	51	42
CJLINE/EC-1235-4M-0.33 IE5	1370	2.3	0.25	2820	56	54
CJLINE/EC-1640-4M-0.75 IE5	1385	4.8	0.55	4430	61	76
CJLINE/EC-1845-4M-1.5 IE5	1455	8.9	1.10	6300	65	87
CJLINE/EC-1856-6M-1 IE5	945	4.3	0.75	8100	59	135
CJLINE/EC-2063-6M-1 IE5	945	4.3	0.75	9900	61	188



Erp. (Energy Related Products)

Information on Directive 2009/125/EC can be downloaded from the SODECA website or the QuickFan selector programme.

Acoustic characteristics

The indicated values are determined by measuring the sound pressure level and sound power in dB(A) obtained in a free field at a distance equivalent to twice the size of the fan plus the impeller diameter, with a minimum of 1.5 m.

Sound power spectrum Lw(A) in dB(A) per Hz frequency band

	63	125	250	500	1000	2000	4000	8000
CJLINE/EC-1131-4M	42	51	57	56	60	60	52	46
CJLINE/EC-1235-4M	49	58	64	63	67	66	59	53
CJLINE/EC-1640-4M	56	62	67	68	71	73	65	59
CJLINE/EC-1845-4M	60	66	71	72	75	77	69	63
CJLINE/EC-1856-6M	58	64	69	70	73	72	65	60
CJLINE/EC-2063-6M	60	66	72	72	76	76	68	61

Dimensions mm

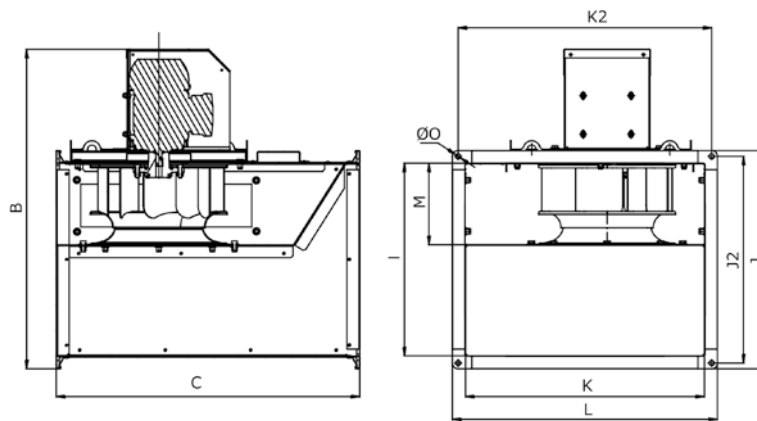

	B	C	I	J	J2	K	K2	L	M2	ØO
CJLINE/EC-1131-4M	783	710	451	510	483	561	593	620	194	12
CJLINE/EC-1235-4M	833	800	501	560	533	621	653	680	222	12
CJLINE/EC-1640-4M	896	900	561	620	593	711	743	770	244	12
CJLINE/EC-1845-4M	965	1000	631	690	663	801	833	860	277	12
CJLINE/EC-1856-6M	1133	1250	801	860	833	1001	1033	1060	348	12
CJLINE/EC-2063-6M	1242	1400	900	980	940	1124	1165	1205	410	14

Accessories



Characteristic curves

Q= Flow rate in m³/h, m³/s and cfm

Pe= Static pressure in mm H₂O, Pa and inwg

CJLINE/EC-1131-4M

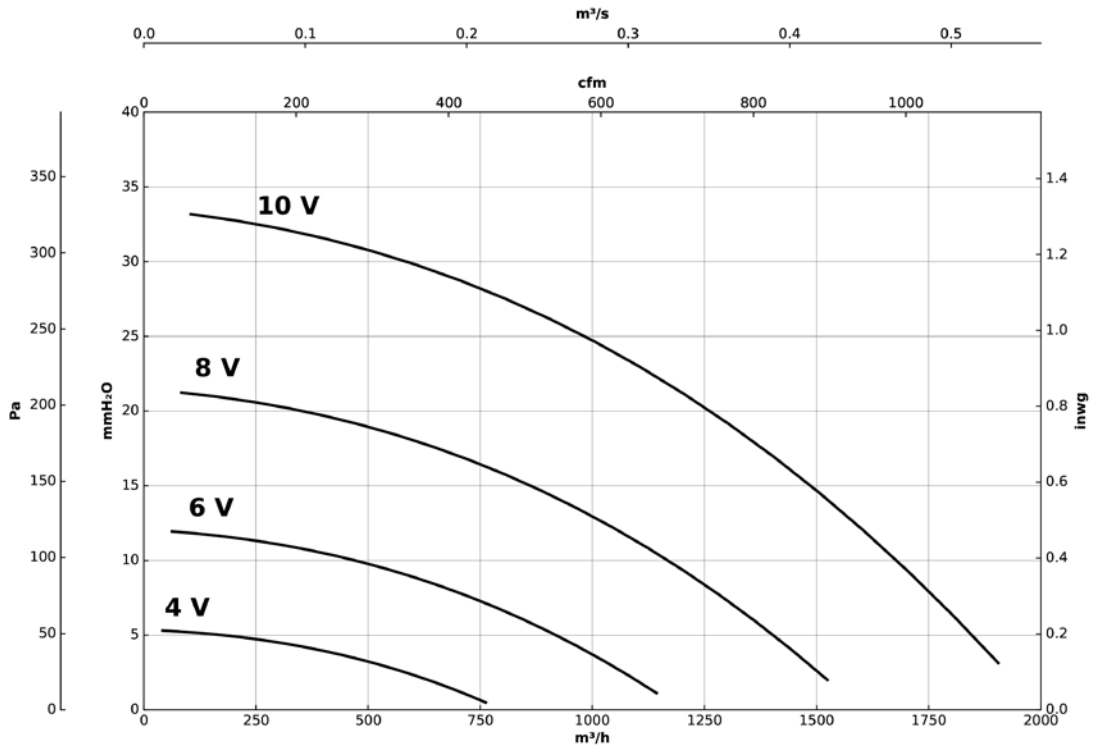

CJLINE/EC-1235-4M

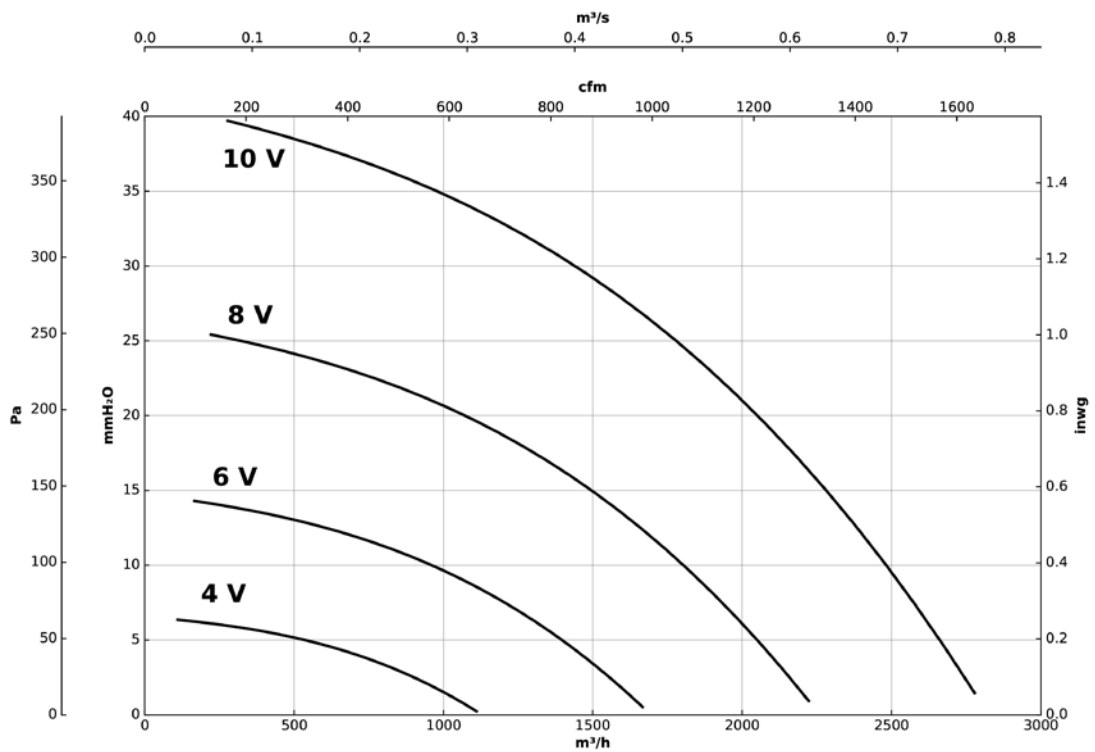

Characteristic curves

Q= Flow rate in m³/h, m³/s and cfm

Pe= Static pressure in mm H₂O, Pa and inwg

CJLINE/EC-1640-4M

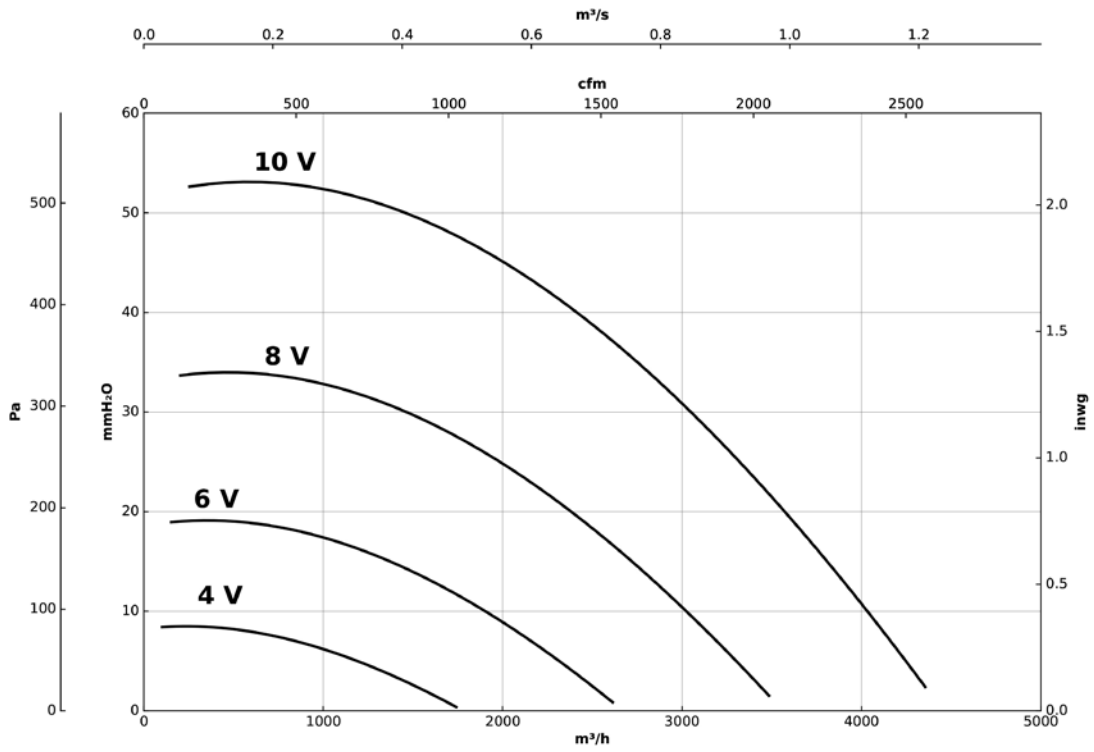

CJLINE/EC-1845-4M

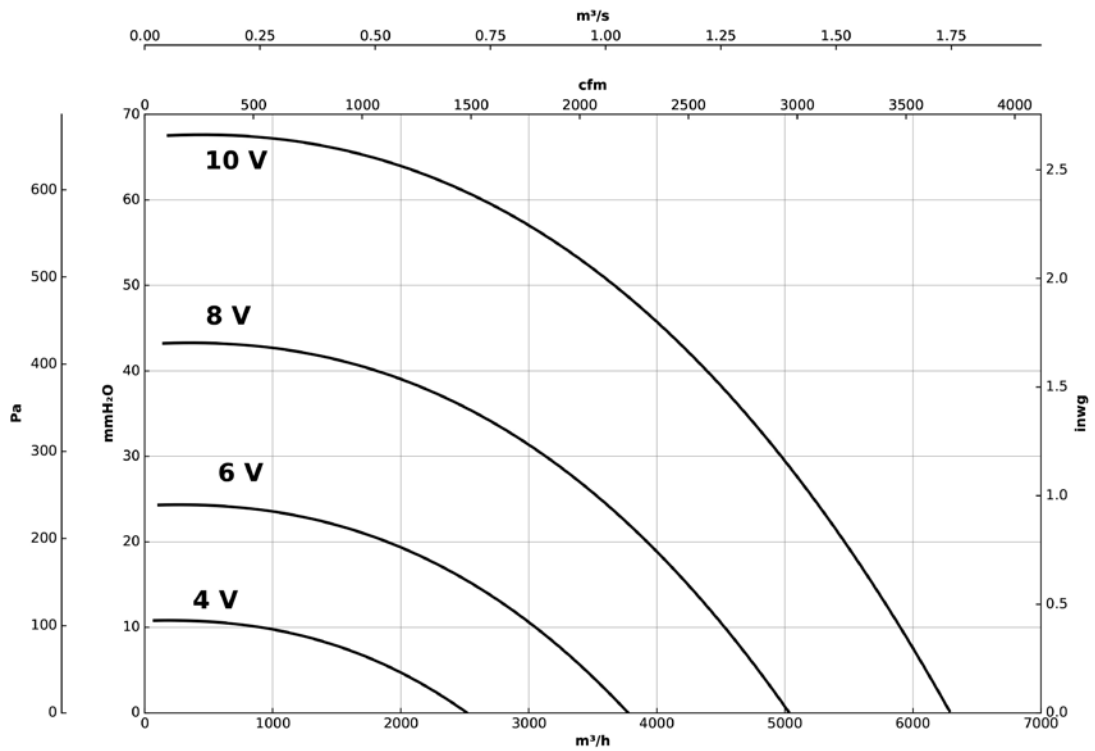

Characteristic curves

Q= Flow rate in m³/h, m³/s and cfm

Pe= Static pressure in mm H₂O, Pa and inwg

CJLINE/EC-1856-6M

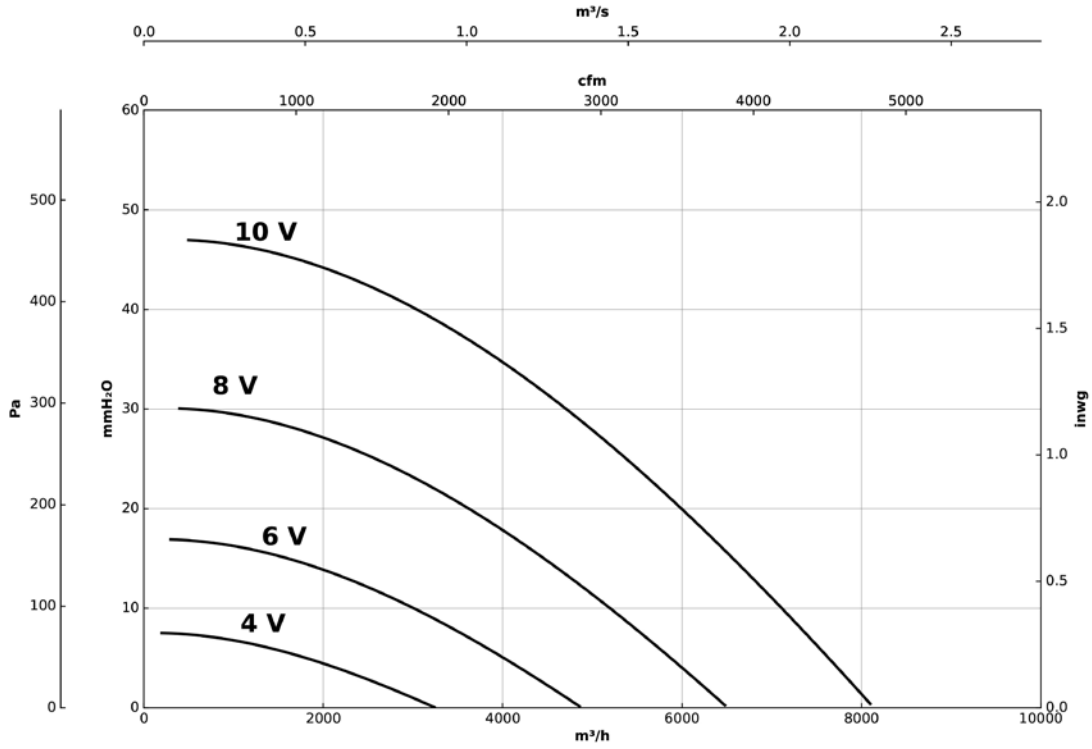

CJLINE/EC-2063-4M

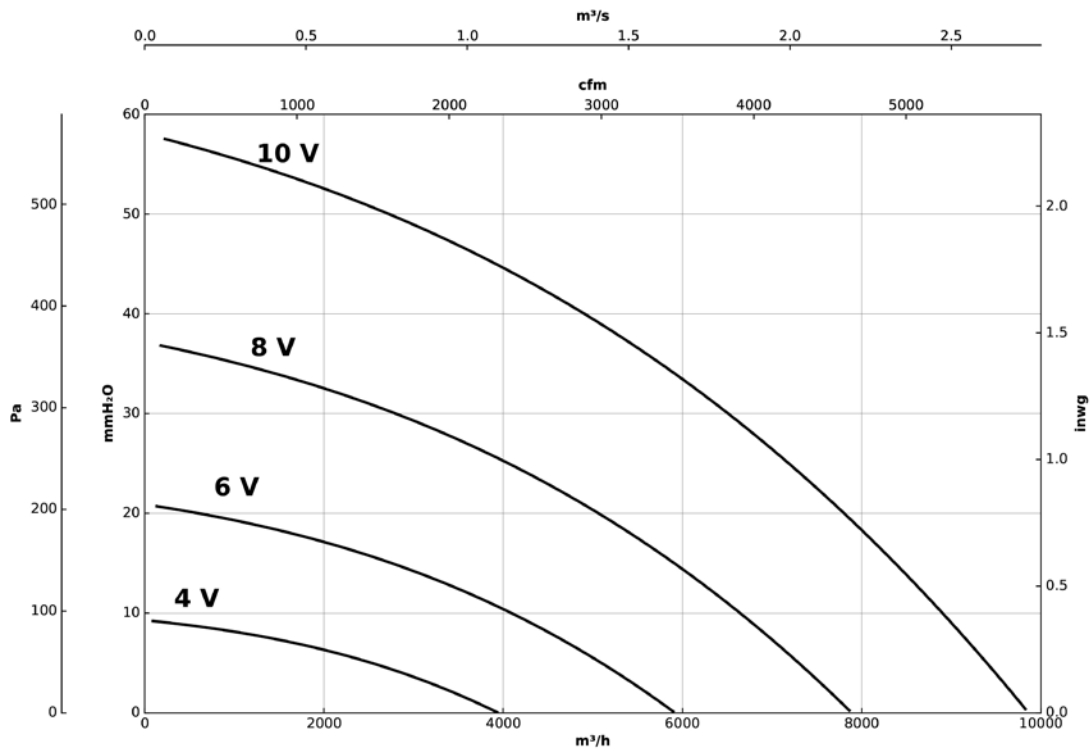

CKD



F400 extractor fan units with a large door for ease of maintenance and 40 mm acoustic insulation slab



- Fan:**
- Galvanised sheet steel structure.
 - 40 mm acoustic insulation.
 - Forward curved impeller in galvanised sheet steel.
 - Approved in accordance with standard EN 12101-3, with certificate no.: 0370-CPR-2358.
 - Changeable opening door direction thanks to its interchangeable hinges.
 - Adjustable in different positions.
 - Prepared for continuous work at 120 °C.
 - Motor cover accessory (CM) supplied with fan.

- Motor:**
- Motors with IE3 efficiency for powers equal to or greater than 0.75 kW, except single-phase, 2-speed and 8-pole.
 - Class F motors with ball bearings and IP55 protection.
 - Single-phase 230 V 50 Hz and three-phase 230/400 V 50 Hz.
 - Working temperature: -25 °C +120 °C.

- Finish:**
- Anti-corrosive in galvanised steel sheet.

- On request:**
- Special windings for different voltages.

Order code

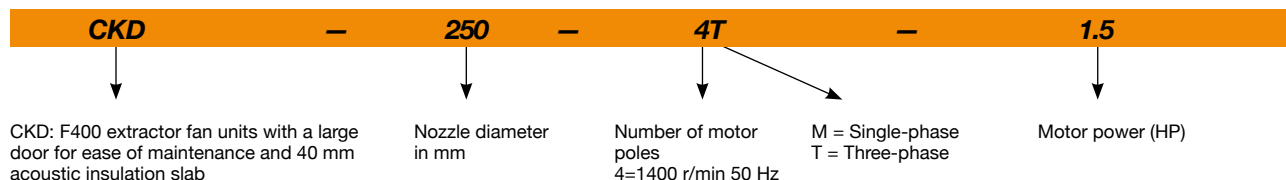

Technical characteristics

Model	Speed (r/min)	Maximum admissible current (A)		Installed power (kW)	Maximum flow rate (m³/h)	Sound pressure level dB (A)	Approx. weight (Kg)
		230V	400V				
CKD-250-4T-1.5 IE3	1455	4.07	2.34	1.1	3160	69	48
CKD-280-4T-3 IE3	1435	7.93	4.56	2.2	4880	73	60



Erp. (Energy Related Products)

Information on Directive 2009/125/EC can be downloaded from the SODECA website or the QuickFan selector programme.

Acoustic characteristics

The indicated values are determined by measuring the sound pressure level and sound power in dB(A) obtained in a free field at a distance equivalent to twice the size of the fan plus the impeller diameter, with a minimum of 1.5 m.

Sound power spectrum Lw(A) in dB(A) per Hz frequency band

	63	125	250	500	1000	2000	4000	8000
CKD-250-4	53	79	74	73	66	67	60	60
CKD-280-4	53	82	78	76	70	71	63	63

Dimensions mm

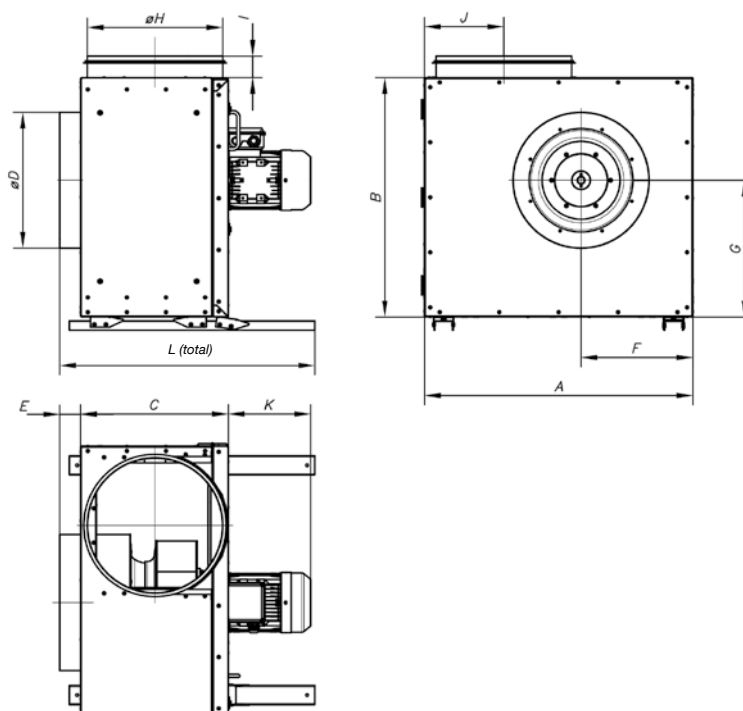

	A	B	C	$\varnothing D$	E	F	G	$\varnothing H$	I	J	K	L
CKD-250	590	520	260	250	50	245	290	250	48	160	225	560
CKD-280	590	520	275	315	50	245	290	250	48	160	287	600

Accessories



INT



RM



VSD3/A-RFT
- VSD1/A-RFM

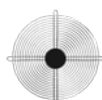

RT



BTUB



PT



ACE ACE/400

Characteristic curves

Q= Flow rate in m³/h, m³/s and cfm

Pe= Static pressure in mm H₂O, Pa and inwg

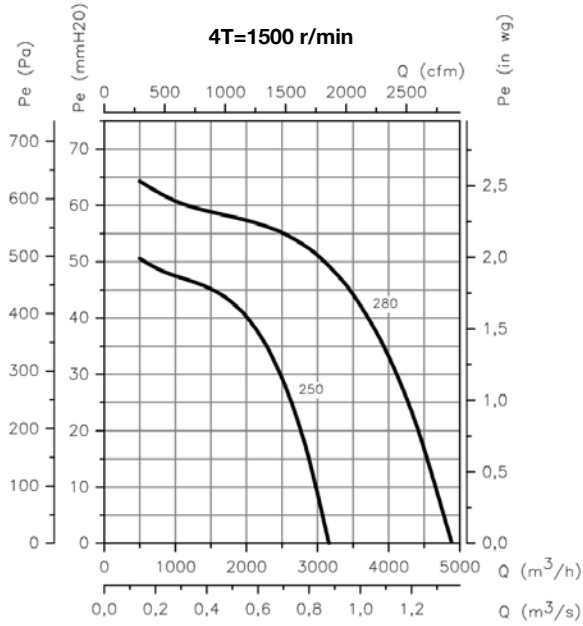

Orientations

Standard supply: LG 0

On request orientations LG 90 and LG 270. Different mounting positions are possible by modifying the feet and interchangeable hinges, depending on each need.

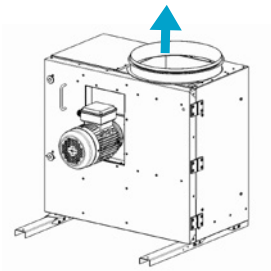

LG 0

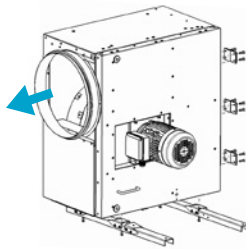

LG 90

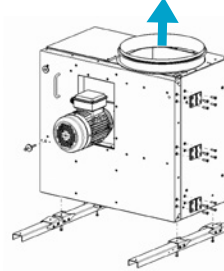

LG 0

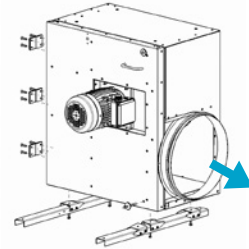

LG 270

Installation

The CKD/CKDR fans can be wall-mounted using angle brackets.

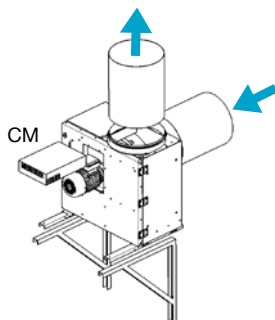

CKDR



F400 extractor fan units with a large door for ease of maintenance and 40 mm acoustic insulation slab



Fan:

- Galvanised sheet steel structure.
- 40 mm acoustic insulation.
- Backward curved impeller made of sheet steel.
- Approved in accordance with standard EN 12101-3, with certificate no.: 0370-CPR-2358.
- Changeable opening door direction thanks to its interchangeable hinges.
- Adjustable in different positions.
- Prepared for continuous work at 120 °C.
- Motor cover accessory (CM) supplied with fan.

Motor:

- Motors with IE3 efficiency for powers equal to or greater than 0.75 kW, except single-phase, 2-speed and 8-pole.
- Class F motors with ball bearings and IP55 protection.
- Single-phase 230 V 50 Hz and three-phase 230/400 V 50 Hz.
- Working temperature: -25 °C +120 °C.

Finish:

- Anti-corrosive in galvanized steel sheet.

On request:

- Special windings for different voltages.

Order code

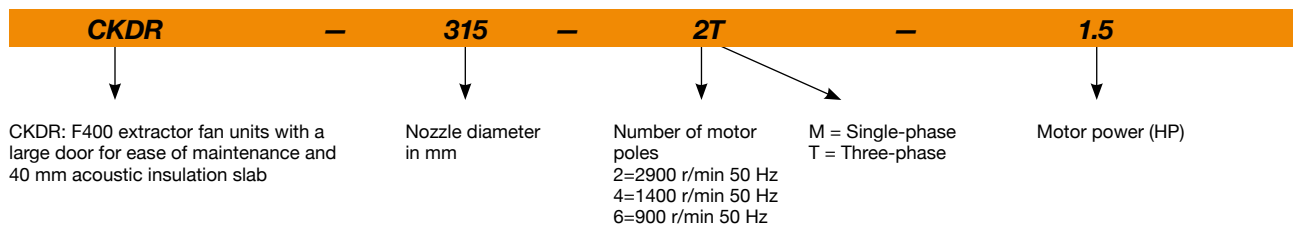

Technical characteristics

Model	Speed (r/min)	Maximum admissible current (A)		Installed power (kW)	Maximum flow rate (m³/h)	Sound pressure level dB (A)	Approx. weight (Kg)
		230V	400V				
CKDR-280-2T-1 IE3	2825	2.80	1.62	0.75	2100	71	38
CKDR-315-2T-1.5 IE3	2830	4.03	2.34	1.10	3910	72	55
CKDR-355-4T-0.5	1370	2.02	1.17	0.37	2670	60	51
CKDR-355-4M-0.5	1420	2.90		0.37	2670	60	53
CKDR-400-4T-0.75	1380	2.92	1.69	0.55	3770	56	66
CKDR-400-4M-0.75	1450	4.40		0.55	3770	56	71
CKDR-450-4T-1 IE3	1420	2.82	1.62	0.75	5020	60	77
CKDR-450-4M-1	1410	5.05		0.75	5020	60	77
CKDR-500-4T-1.5 IE3	1455	4.07	2.34	1.10	7440	62	106
CKDR-560-4T-3 IE3	1435	7.93	4.56	2.20	11030	65	123



Erp. (Energy Related Products)

Information on Directive 2009/125/EC can be downloaded from the SODECA website or the QuickFan selector programme.

Acoustic characteristics

The indicated values are determined by measuring the sound pressure level and sound power in dB(A) obtained in a free field at a distance equivalent to twice the size of the fan plus the impeller diameter, with a minimum of 1.5 m.

Sound power spectrum Lw(A) in dB(A) per Hz frequency band

	63	125	250	500	1000	2000	4000	8000		63	125	250	500	1000	2000	4000	8000
CKDR-280-2	53	67	73	74	76	77	73	71	CKDR-450-4	45	66	67	67	68	69	64	58
CKDR-315-2	50	67	77	77	79	79	74	71	CKDR-500-4	49	68	64	69	74	68	63	60
CKDR-355-4	43	62	64	65	68	67	61	55	CKDR-560-4	44	75	71	74	74	74	66	62
CKDR-400-4	41	60	62	63	65	64	58	53									

Dimensions mm

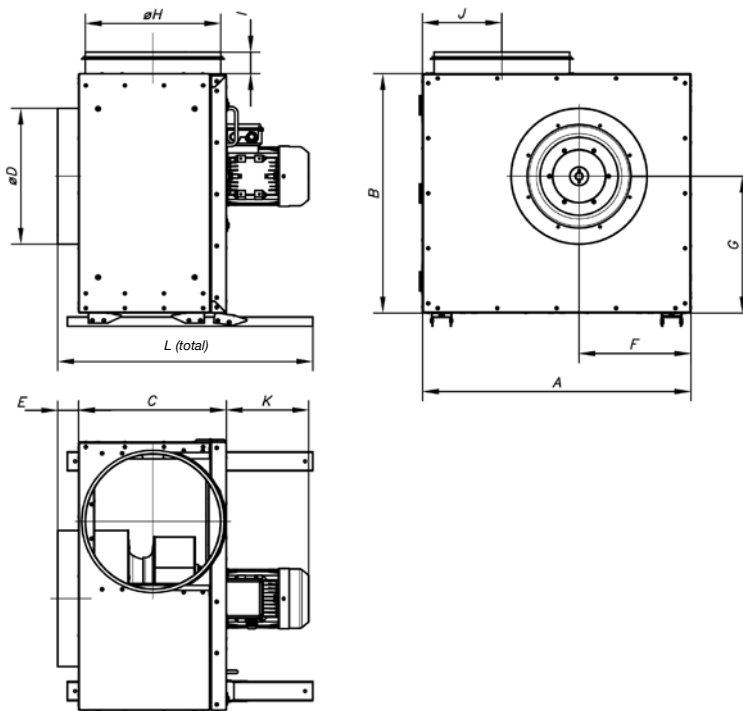

	A	B	C	$\varnothing D$	E	F	G	$\varnothing H$	I	J	K	L
CKDR-280	590	520	345	315	52	245	290	315	48	192.5	215	612
CKDR-315	700	625	385	355	55	290	356	355	56	207	215	665
CKDR-355	700	625	385	355	55	290	356	355	56	207	182	665
CKDR-400	830	775	385	355	55	354	418	355	56	212	214	660
CKDR-450	830	775	385	355	55	354	418	355	56	212	214	660
CKDR-500	1000	900	470	400	75	420	505	400	75	244	224	865
CKDR-560	1000	900	470	400	75	420	505	400	75	244	285	865

Characteristic curves

Q= Flow rate in m³/h, m³/s and cfm

Pe= Static pressure in mm H₂O, Pa and inwg

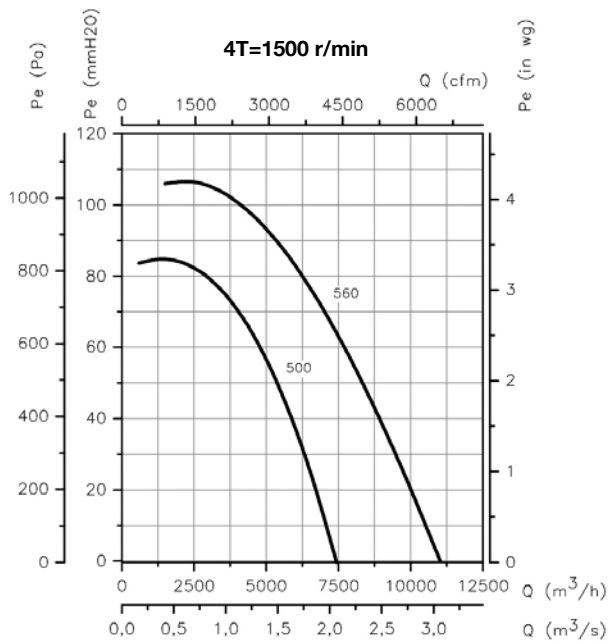
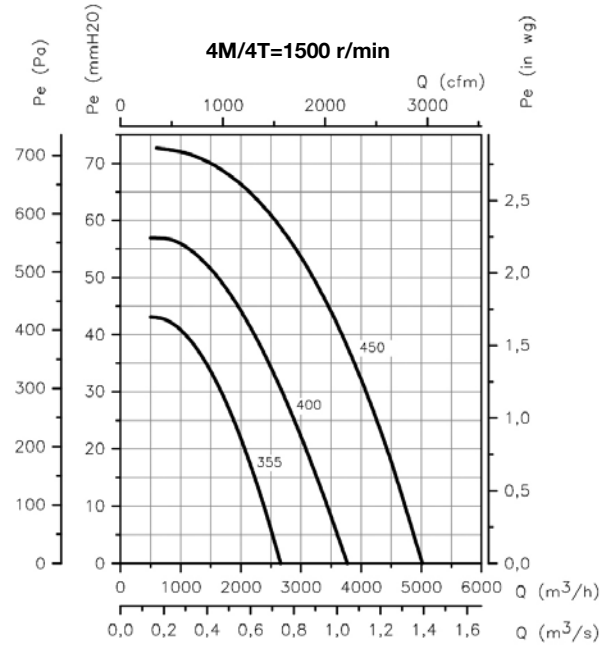
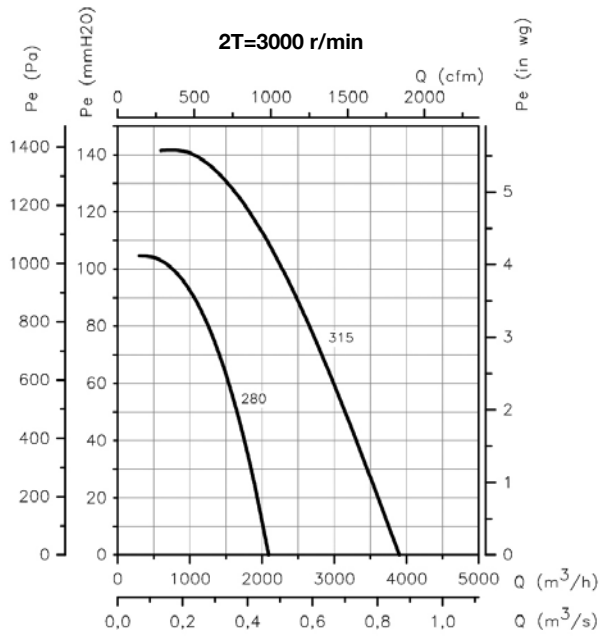

Orientations

Standard supply: LG 0

On request orientations LG 90 and LG 270. Different mounting positions are possible by modifying the feet and interchangeable hinges, depending on each need.

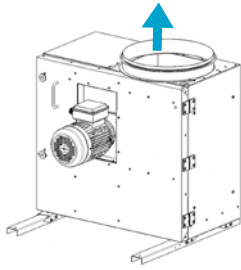

LG 0

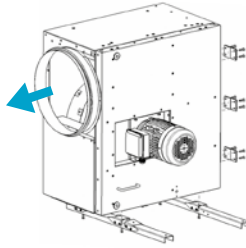

LG 90

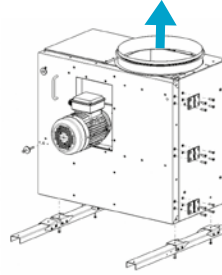

LG 0

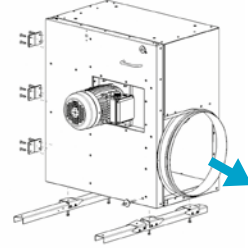

LG 270

Installation

The CKD/CKDR fans can be wall-mounted using angle brackets.

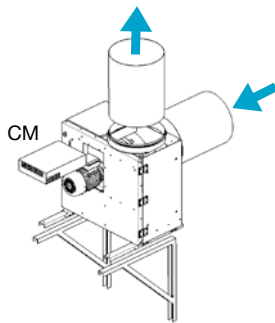

CM

Accessories



INT



RM



VSD3/A-RFT
- VSD1/A-RFM

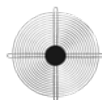

RT



BTUB



PT



ACE ACE/400

CKDR/EC

Extract units with large door and 40 mm acoustic insulation, equipped with EC Technology IE5 motor



Extraction units with large door for easy maintenance and 40 mm acoustic insulation, equipped with EC Technology IE5 motor with integrated electronics.

Fan:

- Galvanised sheet steel structure.
- 40 mm acoustic insulation.
- Backward curved impeller made of sheet steel.
- Changeable opening door direction thanks to its interchangeable hinges.
- Adjustable in different positions.
- Prepared for continuous work at 120 °C.
- Motor cover accessory (CM) supplied with fan.

EC CONTROL: Supplied as an optional accessory. Control panel for ventilation systems with EC Technology motors with the electronics integrated in the motor itself. With the following characteristics:

- CPC: Constant pressure control.
- CFC: Constant flow control.
- DAY/NIGHT: Double pressure setpoint adjustment according to time of day.
- External sensor: compatible with temperature, humidity, air quality or CO sensor.
- Equipment preconfigured in constant pressure mode with 100 Pa set point.

Finish:

- Anti-corrosive in galvanized steel sheet.



EC TECHNOLOGY MOTOR with integrated electronics



EC CONTROL Supplied as an optional accessory

Motor:

- High efficiency EC Technology motors with integrated electronics, regulated by 0-10 V or 4-20 mA.
- IE5 efficiency motors, class F and IP55 protection.
- Single-phase 230 V 50/60 Hz.
- Working temperature: -25 °C +60 °C.

Order code

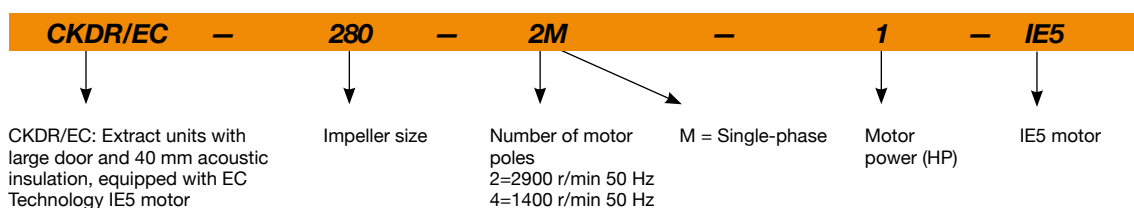

Technical characteristics

Model	Speed	Maximum admissible current (A)	Max. electric power	Maximum flow rate	Sound pressure level	Approx. weight
	(r/min)	230V	(kW)	(m³/h)	dB (A)	(Kg)
CKDR/EC-280-2M-1 IE5	2825	5.9	0.75	2090	71	38
CKDR/EC-315-2M-1,5 IE5	2830	8.7	1.10	3900	72	55
CKDR/EC-355-4M-0.5 IE5	1400	3.4	0.37	2670	60	71
CKDR/EC-400-4M-0.75 IE5	1400	4.8	0.55	3770	56	71
CKDR/EC-450-4M-1 IE5	1410	5.8	0.75	5020	60	77
CKDR/EC-500-4M-1.5 IE5	1455	8.9	1.10	7440	62	106



Erp. (Energy Related Products)

Information on Directive 2009/125/EC can be downloaded from the SODECA website or the QuickFan selector programme.

Acoustic characteristics

The indicated values are determined by measuring the sound pressure level and sound power in dB(A) obtained in a free field at a distance equivalent to twice the size of the fan plus the impeller diameter, with a minimum of 1.5 m.

Sound power spectrum Lw(A) in dB(A) per Hz frequency band

	63	125	250	500	1000	2000	4000	8000		63	125	250	500	1000	2000	4000	8000
CKDR/EC-280-2M-1	53	67	73	74	76	77	73	71	CKDR/EC-400-4M-0.75	41	60	62	63	65	64	58	53
CKDR/EC-315-2M-1,5	50	67	77	77	79	79	74	71	CKDR/EC-450-4M-1	45	66	67	67	68	69	64	58
CKDR/EC-355-4M-0.5	43	62	64	65	68	67	61	55	CKDR/EC-500-4M-1.5	49	68	64	69	74	68	63	60

Dimensions mm

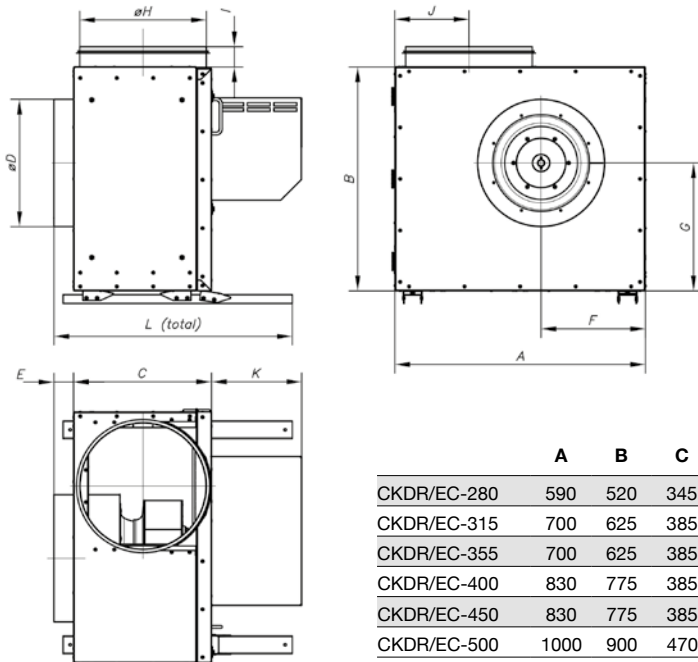

	A	B	C	ØD	E	F	G	ØH	I	J	K	L
CKDR/EC-280	590	520	345	315	52	245	290	315	48	192,5	210	612
CKDR/EC-315	700	625	385	355	55	290	356	355	56	207	210	665
CKDR/EC-355	700	625	385	355	55	290	356	355	56	207	188	665
CKDR/EC-400	830	775	385	355	55	354	418	355	56	212	209	660
CKDR/EC-450	830	775	385	355	55	354	418	355	56	212	229	660
CKDR/EC-500	1000	900	470	400	75	420	505	400	75	244	229	865

Accessories



Characteristic curves

Q= Flow rate in m³/h, m³/s and cfm

Pe= Static pressure in mm H₂O, Pa and inwg

CKDR-280-2M-1 IE5

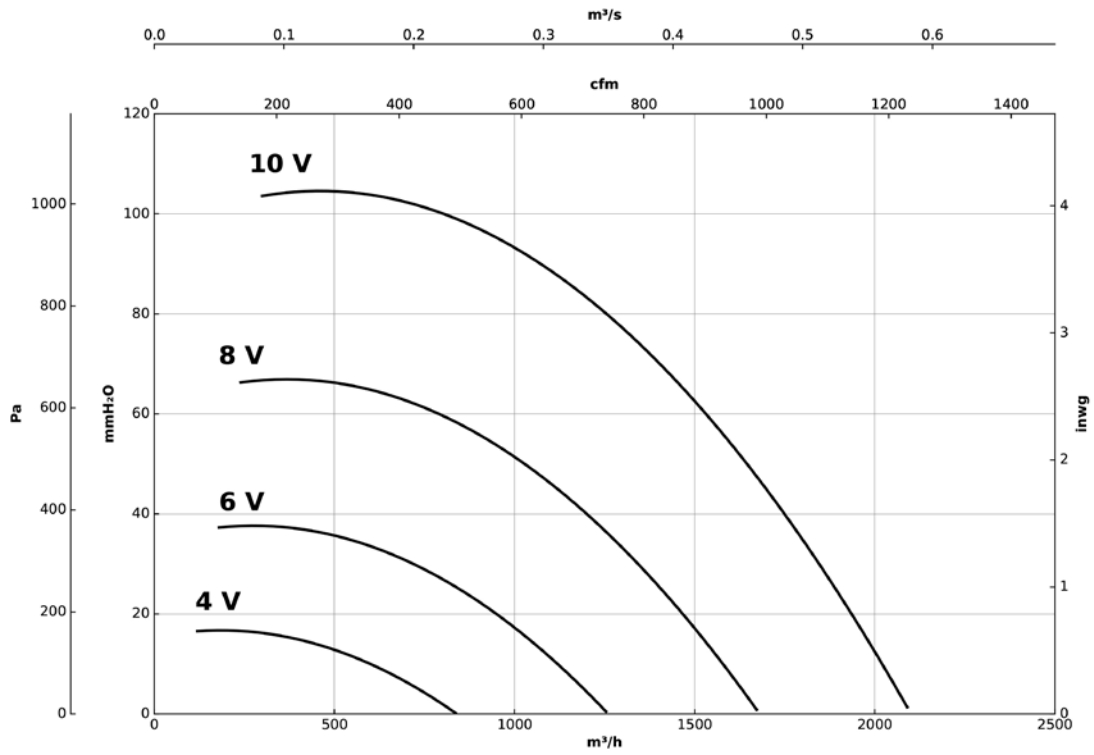

CKDR-315-2M-1,5 IE5

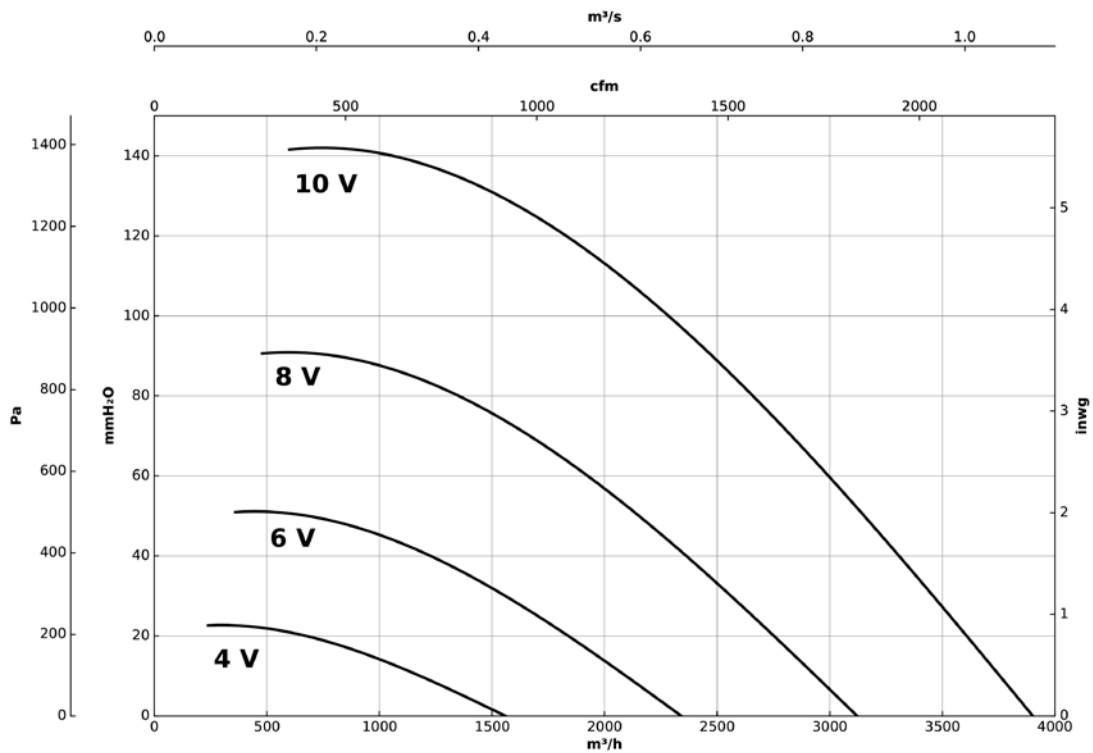

Characteristic curves

Q= Flow rate in m³/h, m³/s and cfm

Pe= Static pressure in mm H₂O, Pa and inwg

CKDR-355-4M-0.5 IE5

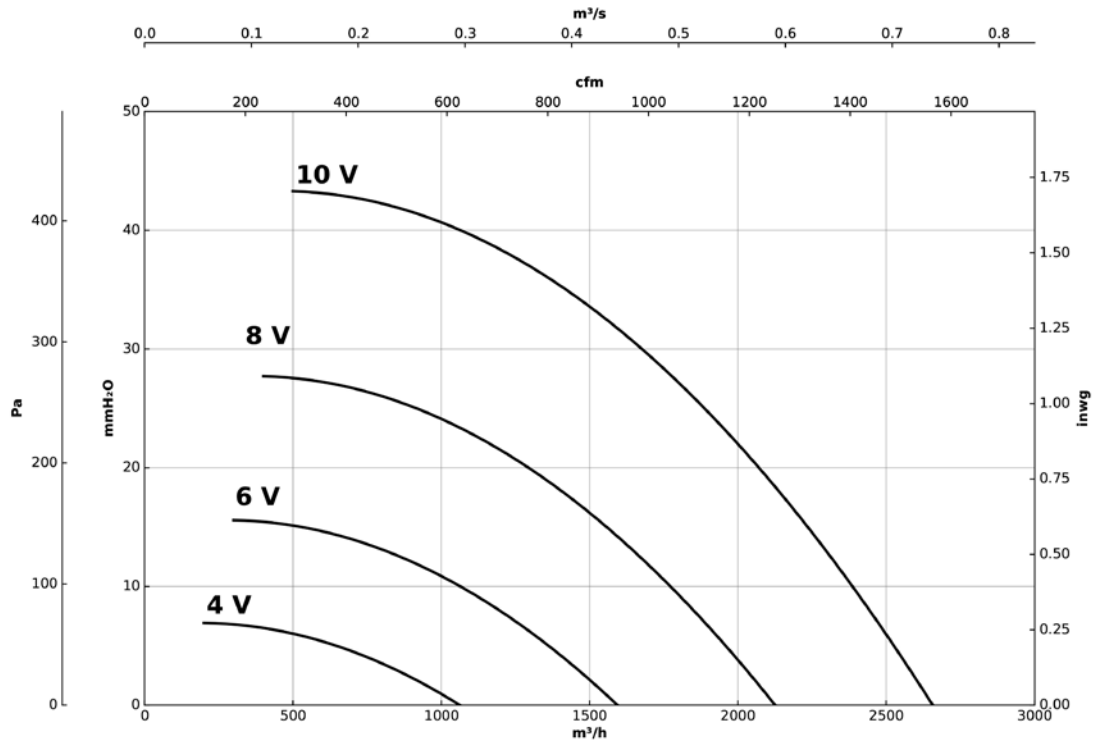

CKDR-400-4M-0.75 IE5

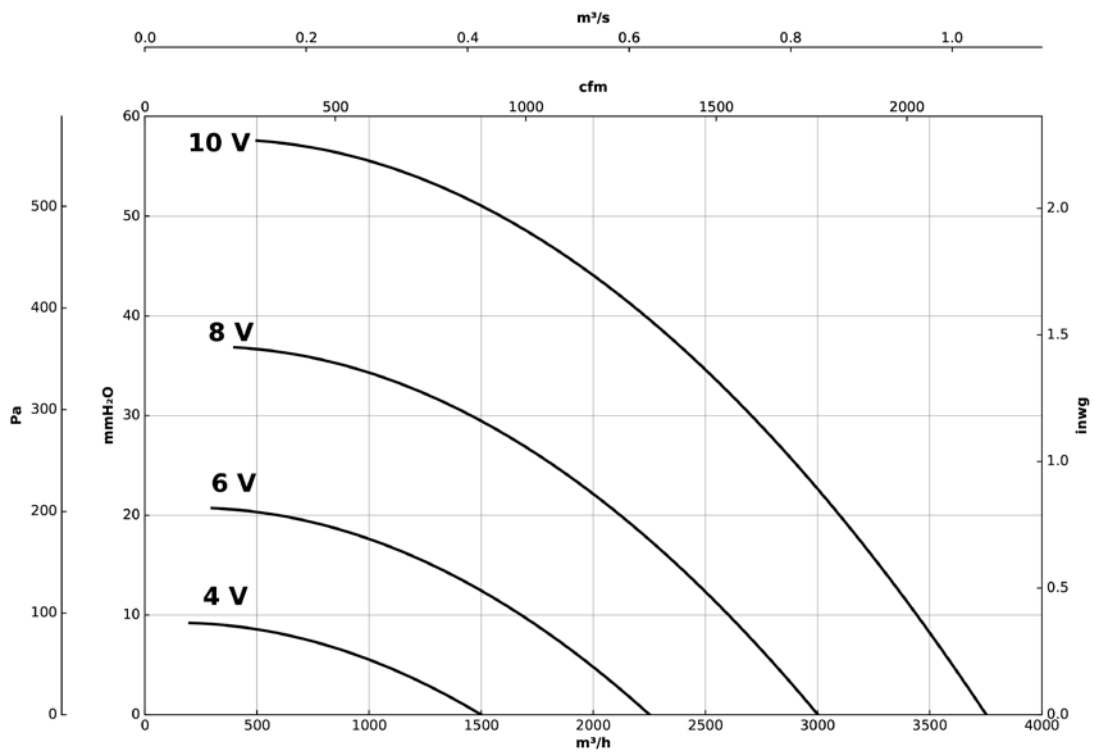

Characteristic curves

Q= Flow rate in m³/h, m³/s and cfm

Pe= Static pressure in mm H₂O, Pa and inwg

CKDR-450-4M-1 IE5

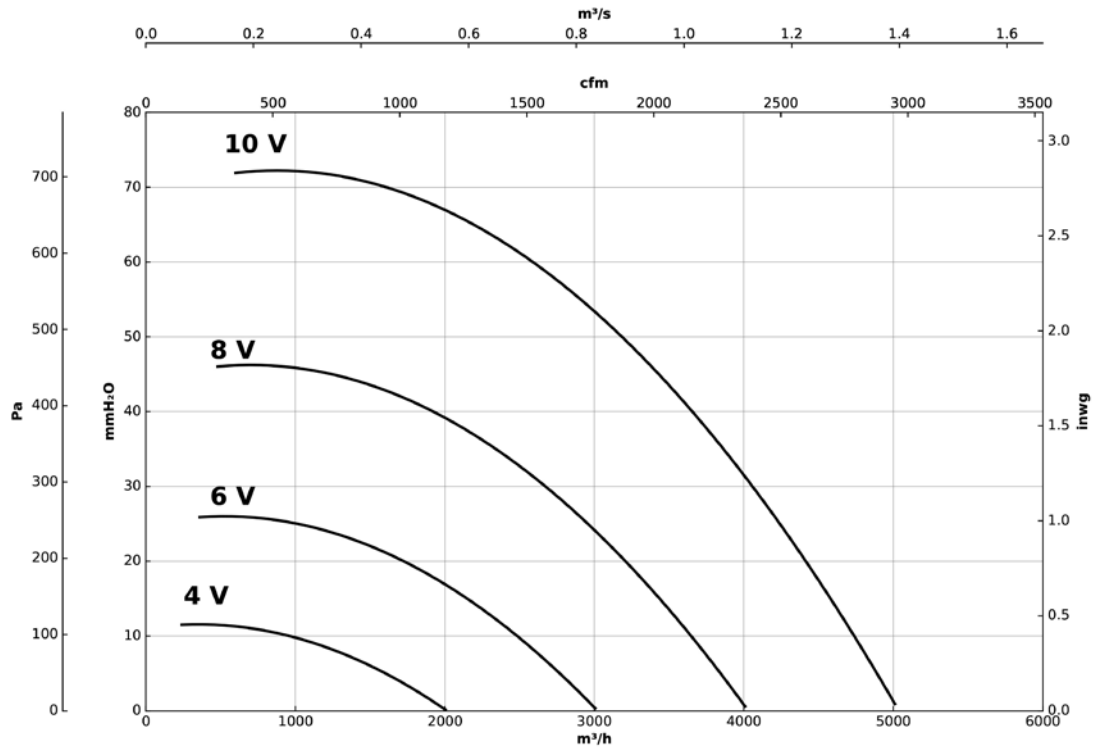

CKDR-500-4M-1.5 IE5

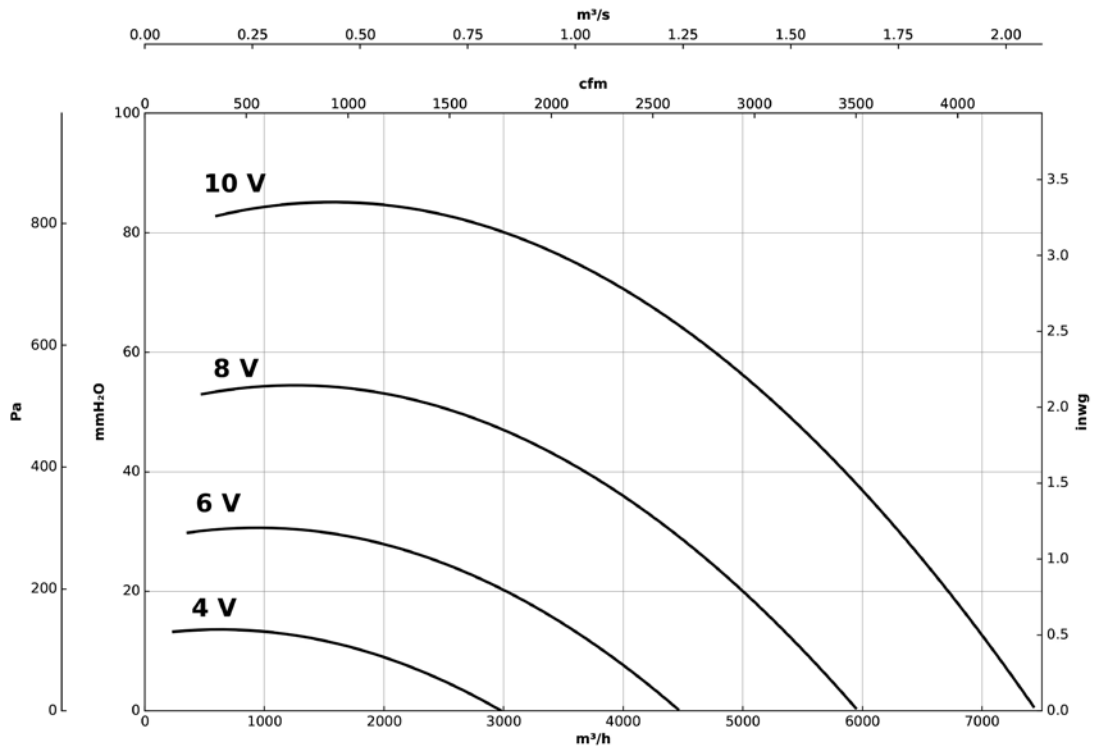

CHT

400 °C/2h centrifugal roof fans with horizontal air outlet, aluminum hood



Fan:

- Support base in galvanized steel sheet.
- Backward curved impeller made of galvanized sheet steel.
- Bird protection grid.
- Aluminum rain cover.
- Approved in accordance with standard EN 12101-3, with certificate no.: 0370-CPR-1892.
- Maximum temperature of air to be carried: -25 °C +120 °C.

- Class F motors with ball bearings. IP55 protection. Except single-phase models, with IP54 protection. 1 or 2 speeds depending on model.
- Single-phase 230 V 50 Hz and three-phase 230/400 V 50 Hz.
- Working temperature: -25 °C +50 °C.

Finish:

- Anti-corrosive in galvanized steel sheet and aluminum.

Motor:

- Motors with IE3 efficiency for powers equal to or greater than 0.75 kW, except single-phase, 2-speed and 8-pole.

On request:

- Special windings for different voltages.
- ATEX certified Category 3.

Order code

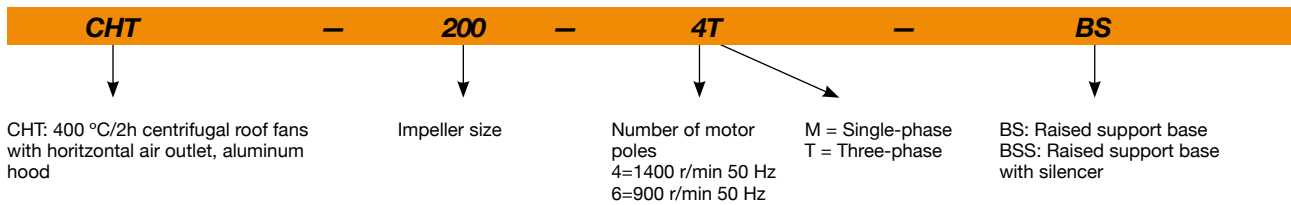

Technical characteristics

Model	Speed (r/min)	Maximum admissible current (A)		Installed power (kW)	Maximum flow rate (m³/h)	Sound pressure level ¹ dB (A)		Approx. weight (Kg)
		230V	400V			Inlet	Exhaust	
CHT-200-4T	1350	1.66	0.96	0.25	1450	36	43	25
CHT-200-4M	1380	1.70		0.25	1450	36	43	25
CHT-225-4T	1350	1.66	0.96	0.25	2100	40	46	25
CHT-225-4M	1380	2.60		0.25	2100	40	46	25
CHT-250-4T	1350	1.66	0.96	0.25	3100	44	49	34
CHT-250-4M	1380	2.60		0.25	3100	44	49	34
CHT-315-4T	1380	2.92	1.69	0.55	4950	47	53	39
CHT-315-4M	1380	3.30		0.55	4950	47	53	39
CHT-400-4T IE3	1420	2.82	1.62	0.75	7000	54	60	58
CHT-400-4M	1380	4.40		0.75	7000	54	60	57
CHT-400-6T	900	2.24	1.30	0.37	4500	43	49	56
CHT-450-4T IE3	1440	5.41	3.11	1.50	10200	58	63	74
CHT-450-6T	900	2.24	1.30	0.37	6720	46	53	59
CHT-500-6T IE3	945	4.68	2.69	1.10	12000	50	55	109
CHT-560-6T IE3	950	9.08	5.22	2.20	17300	53	59	130
CHT-630-6T IE3	960	15.60	8.99	4.00	24700	57	61	166

¹ Sound pressure level in dB(A) at a distance of 6 m and at maximum flow rate.



Erp. (Energy Related Products)

Information on Directive 2009/125/EC can be downloaded from the SODECA website or the QuickFan selector programme.

Acoustic characteristics

Sound power spectrum Lw(A) in dB(A) per Hz frequency band

Values measured at inlet with maximum flow rate (Qmax)

	63	125	250	500	1000	2000	4000	8000
CHT-200-4	37	43	54	57	58	54	52	46
CHT-225-4	44	53	58	58	62	61	54	48
CHT-250-4	48	57	62	62	66	65	58	52
CHT-315-4	52	58	64	64	67	70	61	55
CHT-400-4	59	65	71	71	74	77	68	62
CHT-400-6	48	54	60	60	63	66	57	51
CHT-450-4	64	71	76	76	80	79	72	67
CHT-450-6	52	59	64	64	68	67	60	55
CHT-500-6	56	62	67	68	72	71	64	57
CHT-560-6	59	65	70	71	75	74	67	60
CHT-630-6	63	69	74	75	79	78	71	64

Values measured at exhaust with maximum flow rate (Qmax)

	63	125	250	500	1000	2000	4000	8000
CHT-200-4	41	46	60	62	63	63	58	53
CHT-225-4	43	52	62	66	69	66	59	53
CHT-250-4	46	55	65	69	72	69	62	56
CHT-315-4	51	63	71	73	74	74	66	58
CHT-400-4	58	70	78	80	81	81	73	65
CHT-400-6	47	59	67	69	70	70	62	54
CHT-450-4	62	74	82	84	85	82	75	67
CHT-450-6	52	64	72	74	75	72	65	57
CHT-500-6	52	66	74	78	77	74	68	62
CHT-560-6	56	70	78	82	81	78	72	66
CHT-630-6	59	73	81	85	74	81	75	69

Dimensions mm

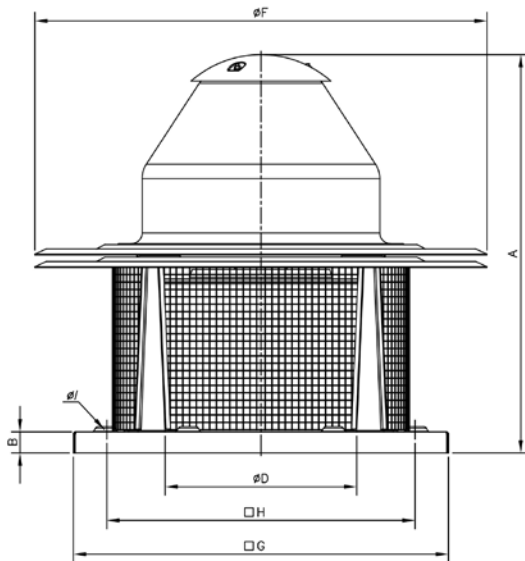

	A	B	øD*	øF	G	H	øI
CHT-200	530	20	250	570	450	360	12
CHT-225	548	20	250	570	450	360	12
CHT-250	620	30	355	726	560	450	12
CHT-315	670	30	355	726	560	450	12
CHT-400	755	40	500	856	710	590	12
CHT-450	770	40	500	856	710	590	12
CHT-500	846	40	630	1072	900	750	14
CHT-560	1035	40	710	1300	1100	900	14
CHT-630	1096	40	710	1300	1100	900	14

* Recommended nominal tube diameter

Characteristic curves

Q= Flow rate in m³/h, m³/s and cfm

Pe= Static pressure in mm H₂O, Pa and inwg

4M/4T=1500 r/min

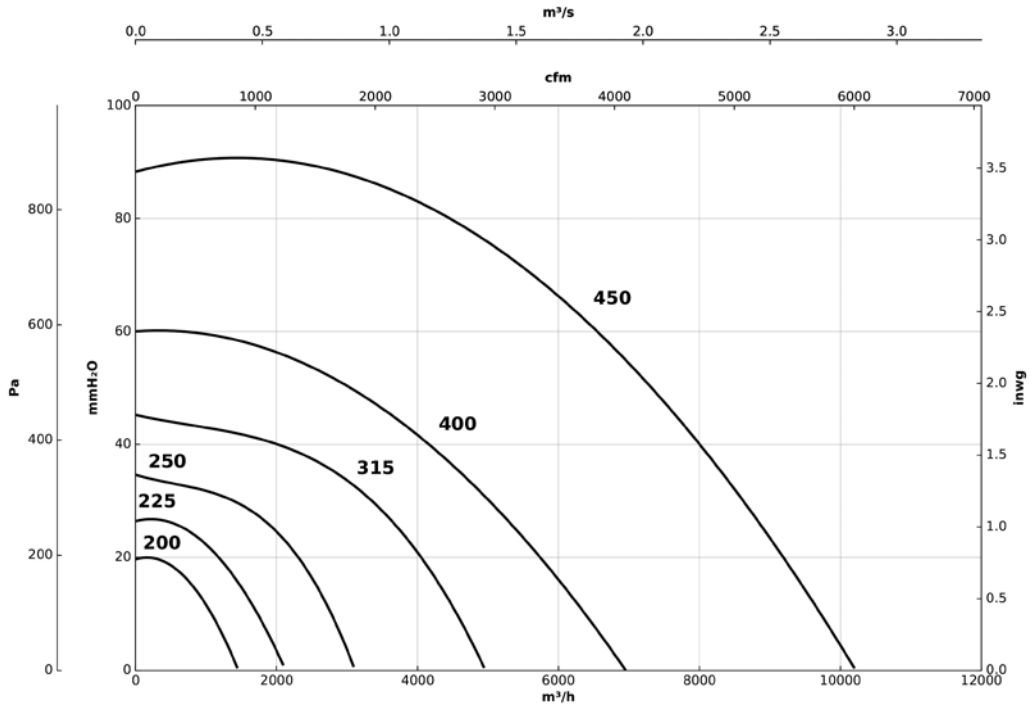

6T=1000 r/min

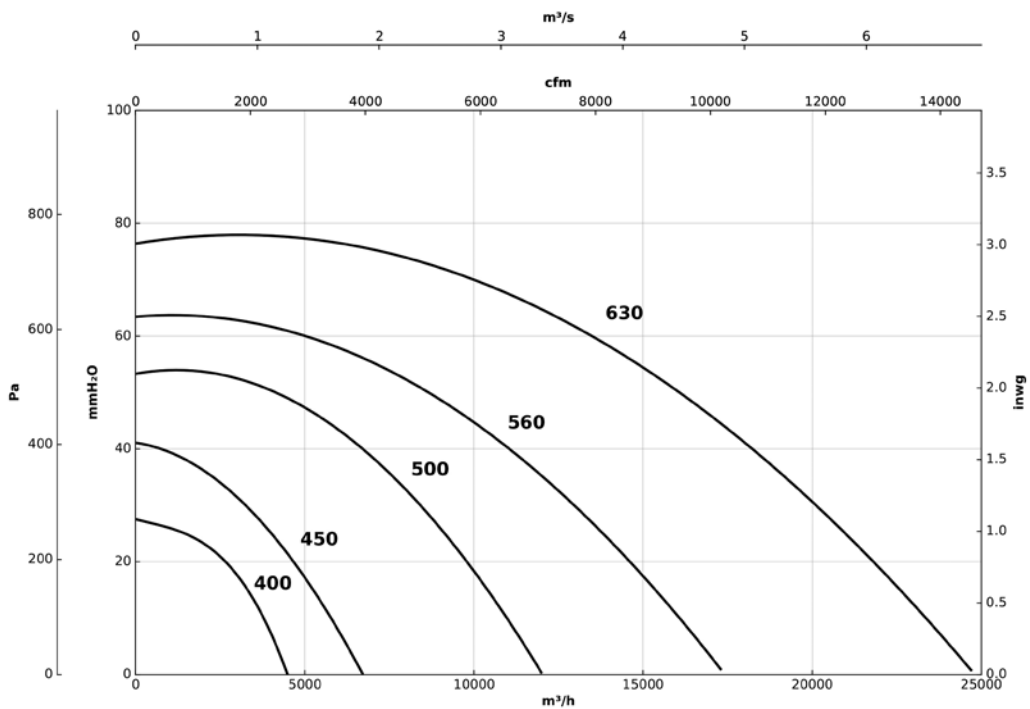

Sound pressure variation depending on distance

The noise level may vary depending on the roof or tile structure.

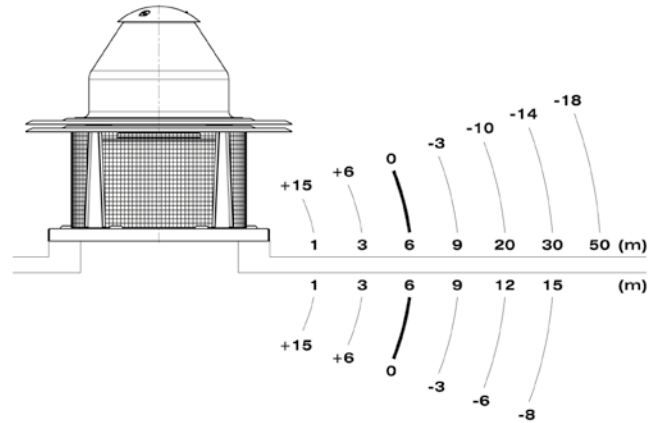

Application example

Extract fans suitable for use in industrial kitchens

For the correct application of standard:

- C.T.E. Código Técnico de la Edificación (Technical Building Code). Basic Document SI on fire safety. Basic Document HS on health and safety.

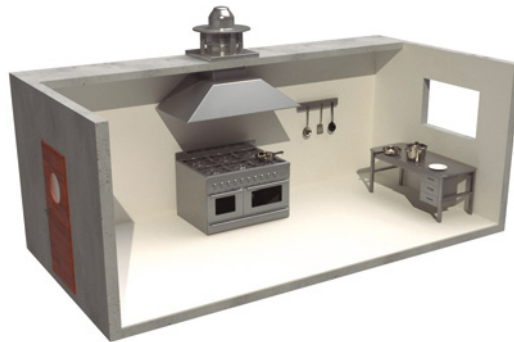

Accessories



INT



C2V



RM



VSD3/A-RFT
- VSD1/A-RFM



B



BAC

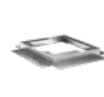

MS



PA



BS



BSS



PT



S



SI-PIR



SI-TEMP+HUMEDAD



SI-PRESIÓN



SI-FUENTE DE ALIMENTACIÓN



SI-VENT



SI-PRESOSTATO

CHT/EC

Centrifugal roof fans with horizontal air outlet, with EC Technology IE5 motor



Fan:

- Support base in galvanized steel sheet.
- Backward curved impeller made of galvanized sheet steel.
- Bird protection grid.
- Aluminum rain cover.
- Airflow direction from motor to impeller.

- DAY / NIGHT: Double pressure setpoint adjustment according to time of day.
- External sensor: compatible with temperature, humidity, air quality or CO sensor.
- Equipment preconfigured in constant pressure mode with 100 Pa set point.

Motor:

- High efficiency EC Technology motors with integrated electronics, regulated by 0-10 V or 4-20 mA.
- IE5 efficiency motors, class F and IP55 protection.
- Single-phase 230 V 50/60 Hz.
- Working temperature: -25 °C +60 °C.

Finish:

- Anti-corrosive in galvanized steel sheet and aluminum.



← EC TECHNOLOGY MOTOR with integrated electronics



← EC CONTROL Supplied as an optional accessory

EC CONTROL: Supplied as an optional accessory. Control panel for ventilation systems with EC Technology motors with the electronics integrated in the motor itself. With the following characteristics:

- CPC: Constant pressure control.
- CFC: Constant flow control.

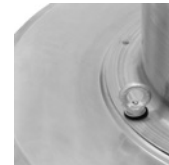

Support for roof-mounting



Order code

CHT/EC – **315** – **4M** – **0.75** – **IE5**

↓
CHT/EC: Centrifugal roof fans with horizontal air outlet, with EC Technology IE5 motor

↓
Impeller size

↓
Number of motor poles
4=1400 r/min 50 Hz
6=900 r/min 50 Hz

↓
M = Single-phase

↓
Motor power (HP)

↓
IE5 motor

Technical characteristics

Model	Speed (r/min)	Maximum admissible current (A)	Max. electric power	Maximum flow rate	Sound pressure level dB (A)		Approx. weight (Kg)
		230V	(kW)	(m³/h)	Inlet	Exhaust	
CHT/EC-315-4M-0.75 IE5	1380	4.8	0.55	4950	48	54	39
CHT/EC-400-6M-0.55 IE5	900	3.4	0.37	4500	44	50	56
CHT/EC-450-6M-0.55 IE5	900	3.4	0.37	6900	47	54	59



Erp. (Energy Related Products)

Information on Directive 2009/125/EC can be downloaded from the SODECA website or the QuickFan selector programme.

Acoustic characteristics

The indicated values are determined by measuring the sound pressure level and sound power in dB(A) obtained in a free field at a distance equivalent to twice the size of the fan plus the impeller diameter, with a minimum of 1.5 m.

Sound power spectrum Lw(A) in dB(A) per Hz frequency band

Values measured at inlet with maximum flow rate (Qmax)

	63	125	250	500	1000	2000	4000	8000
315-4M	50	56	62	62	65	68	59	53
400-6M	46	52	58	58	61	64	55	49
450-6M	50	57	62	62	66	65	58	53

Values measured at exhaust with maximum flow rate (Qmax)

	63	125	250	500	1000	2000	4000	8000
315-4M	49	61	69	71	72	72	84	58
400-6M	45	57	65	67	68	68	60	52
450-6M	50	62	70	72	73	70	63	55

Dimensions mm

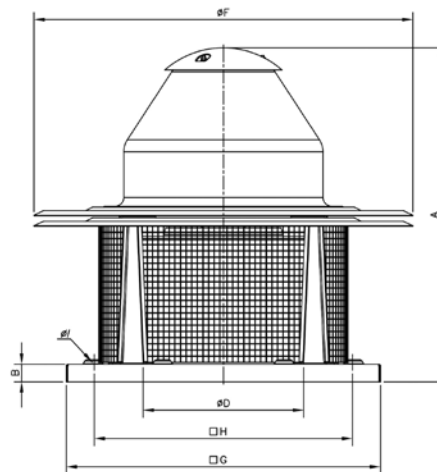

	A	B	øD*	øF	G	H	øl
CHT/EC-315-4M	670	30	355	726	560	450	12
CHT/EC-400-6M	755	40	500	856	710	590	12
CHT/EC-450-6M	770	40	500	856	710	590	12

* Recommended nominal tube diameter

Characteristic curves

Q= Flow rate in m³/h, m³/s and cfm

Pe= Static pressure in mm H₂O, Pa and inwg

CHT/EC-315-4M

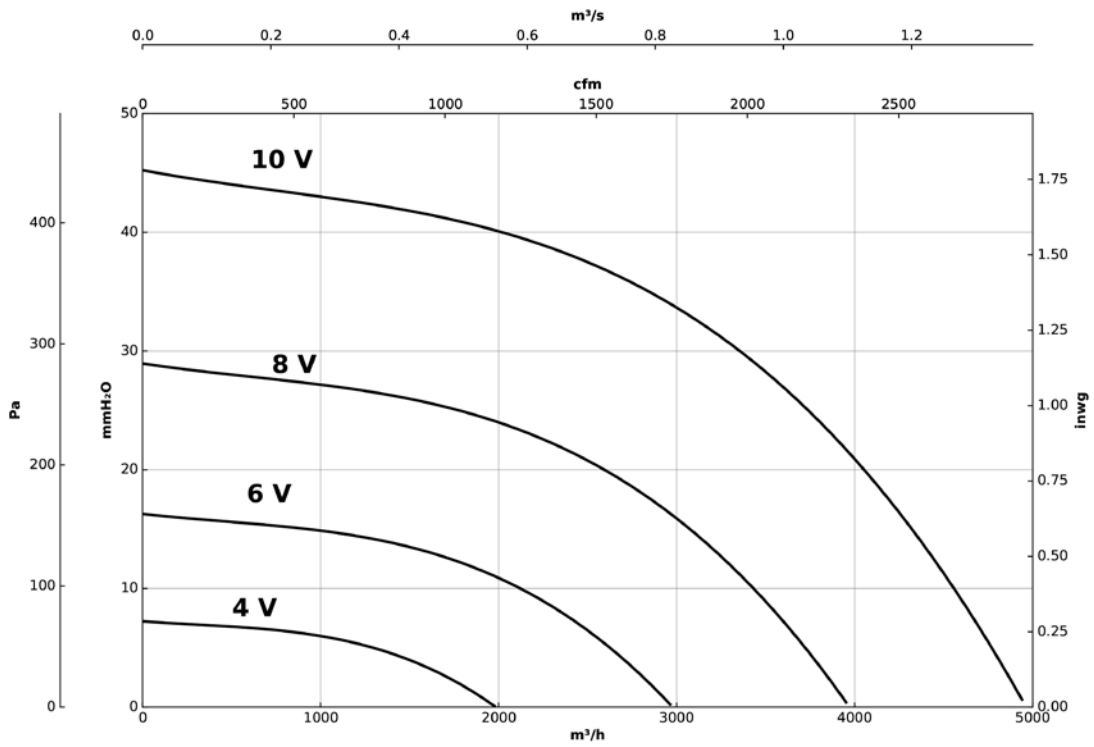

CHT/EC-400-6M

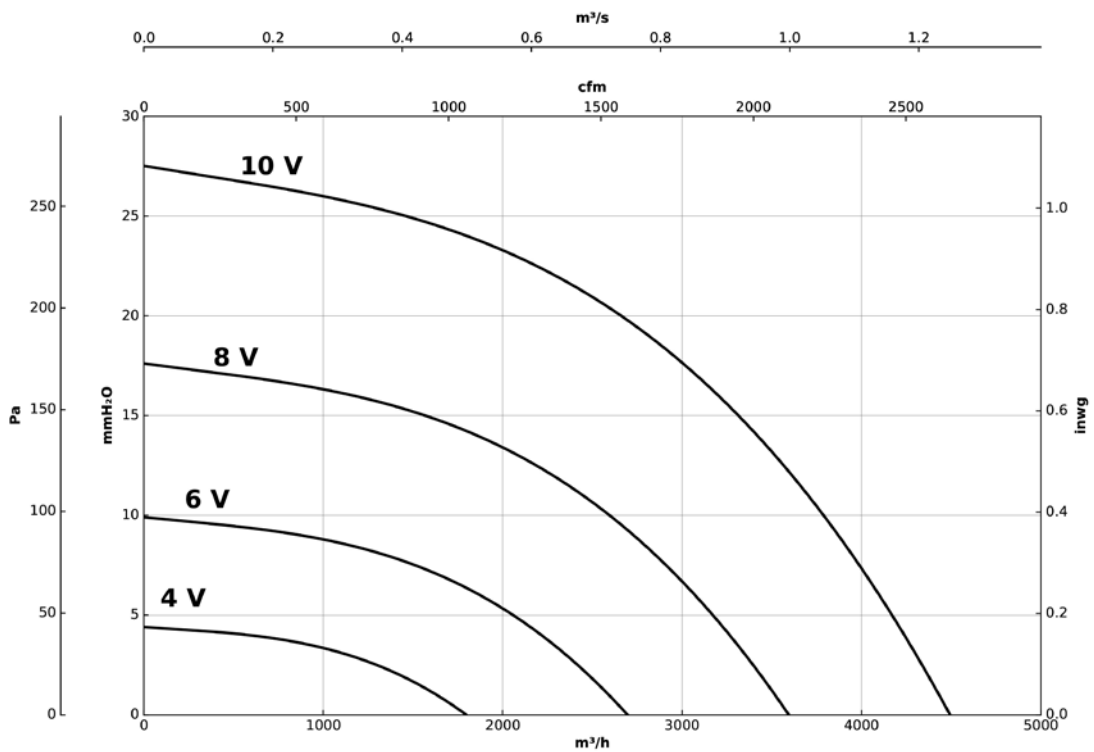

Characteristic curves

Q= Flow rate in m³/h, m³/s and cfm

Pe= Static pressure in mm H₂O, Pa and inwg

CHT/EC-450-6M

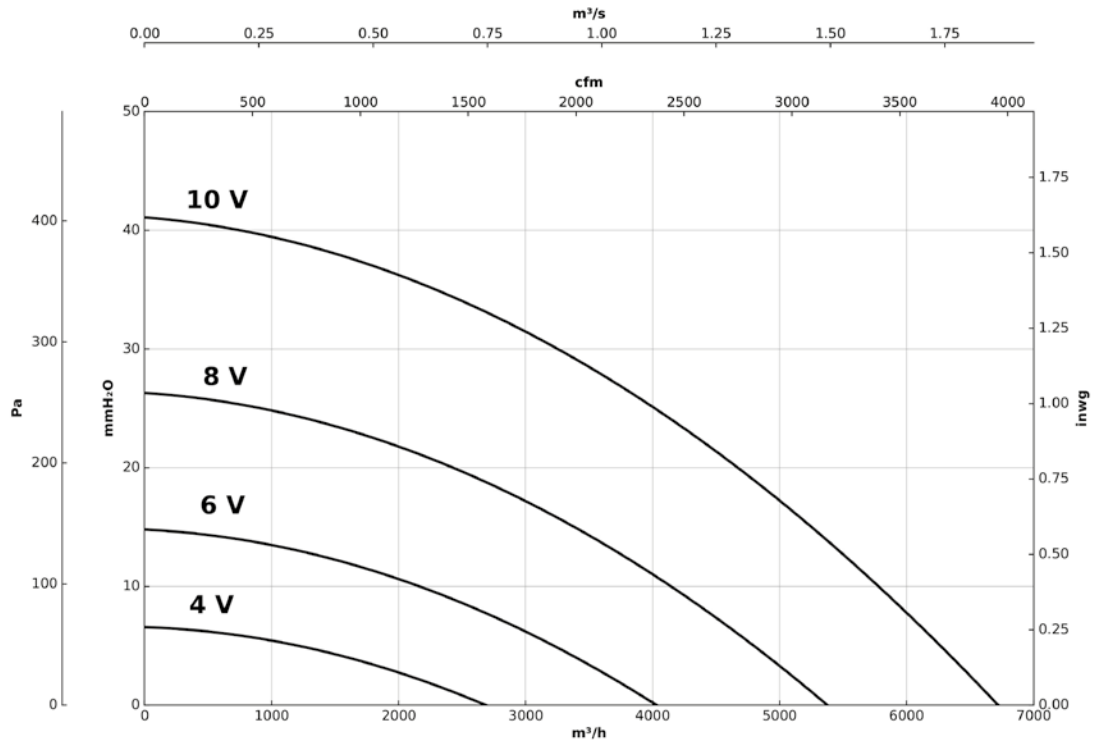

Accessories

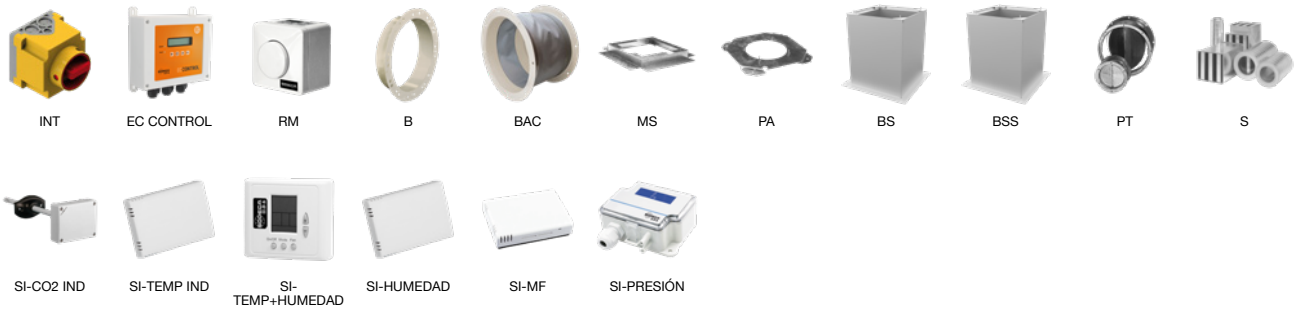

CVT

400 °C/2h centrifugal roof fans with vertical air outlet, aluminum hood



Fan:

- Support base in galvanized steel sheet.
- Backward curved impeller made of galvanized sheet steel.
- Bird protection grid.
- Aluminum rain cover.
- Approved in accordance with standard EN 12101-3, with certificate no.: 0370-CPR-1892.
- Maximum temperature of air to be carried: -25 °C +120 °C.

- Class F motors with ball bearings. IP55 protection. Except single-phase models, with IP54 protection. 1 or 2 speeds depending on model.
- Single-phase 230 V 50 Hz and three-phase 230/400 V 50 Hz.
- Working temperature: -25 °C +50 °C.

Finish:

- Anti-corrosive in galvanized steel sheet and aluminum.

Motor:

- Motors with IE3 efficiency for powers equal to or greater than 0.75 kW, except single-phase, 2-speed and 8-pole.

On request:

- Special windings for different voltages.
- ATEX certified Category 3.

Order code

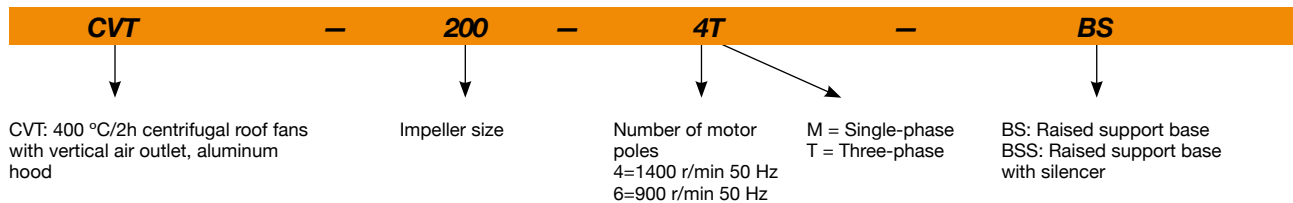

Technical characteristics

Model	Speed (r/min)	Maximum admissible current (A)		Installed power (kW)	Maximum flow rate (m³/h)	Sound pressure level ¹ dB (A)		Approx. weight (Kg)
		230V	400V			Inlet	Exhaust	
CVT-200-4T	1350	1.66	0.96	0.25	1450	36	43	25
CVT-200-4M	1380	1.70		0.25	1450	36	43	25
CVT-225-4T	1350	1.66	0.96	0.25	2100	40	46	25
CVT-225-4M	1380	2.60		0.25	2100	40	46	25
CVT-250-4T	1350	1.66	0.96	0.25	3100	44	49	34
CVT-250-4M	1380	2.60		0.25	3100	44	49	34
CVT-315-4T	1380	2.92	1.69	0.55	4950	47	53	39
CVT-315-4M	1380	3.30		0.55	4950	47	53	39
CVT-400-4T IE3	1420	2.82	1.62	0.75	7000	54	60	58
CVT-400-4M	1380	4.40		0.75	7000	54	60	57
CVT-400-6T	900	2.24	1.30	0.37	4500	43	49	56
CVT-450-4T IE3	1440	5.41	3.11	1.50	10200	58	63	74
CVT-450-6T	900	2.24	1.30	0.37	6720	46	53	59
CVT-500-6T IE3	945	4.68	2.69	1.10	12000	50	55	109
CVT-560-6T IE3	950	9.08	5.22	2.20	17300	53	59	130
CVT-630-6T IE3	960	15.60	8.99	4.00	24700	57	61	166

¹ Sound pressure level in dB(A) at a distance of 6 m and at maximum flow rate.



Erp. (Energy Related Products)

Information on Directive 2009/125/EC can be downloaded from the SODECA website or the QuickFan selector programme.

Acoustic characteristics

Sound power spectrum Lw(A) in dB(A) per Hz frequency band

Values measured at inlet with maximum flow rate (Qmax)

	63	125	250	500	1000	2000	4000	8000
CVT-200-4	37	43	54	57	58	54	52	46
CVT-225-4	44	53	58	58	62	61	54	48
CVT-250-4	48	57	62	62	66	65	58	52
CVT-315-4	52	58	64	64	67	70	61	55
CVT-400-4	59	65	71	71	74	77	68	62
CVT-400-6	48	54	60	60	63	66	57	51
CVT-450-4	64	71	76	76	80	79	72	67
CVT-450-6	52	59	64	64	68	67	60	55
CVT-500-6	56	62	67	68	72	71	64	57
CVT-560-6	59	65	70	71	75	74	67	60
CVT-630-6	63	69	74	75	79	78	71	64

Values measured at exhaust with maximum flow rate (Qmax)

	63	125	250	500	1000	2000	4000	8000
CVT-200-4	41	46	60	62	63	63	58	53
CVT-225-4	43	52	62	66	69	66	59	53
CVT-250-4	46	55	65	69	72	69	62	56
CVT-315-4	51	63	71	73	74	74	66	58
CVT-400-4	58	70	78	80	81	81	73	65
CVT-400-6	47	59	67	69	70	70	62	54
CVT-450-4	62	74	82	84	85	82	75	67
CVT-450-6	52	64	72	74	75	72	65	57
CVT-500-6	52	66	74	78	77	74	68	62
CVT-560-6	56	70	78	82	81	78	72	66
CVT-630-6	59	73	81	85	74	81	75	69

Dimensions mm

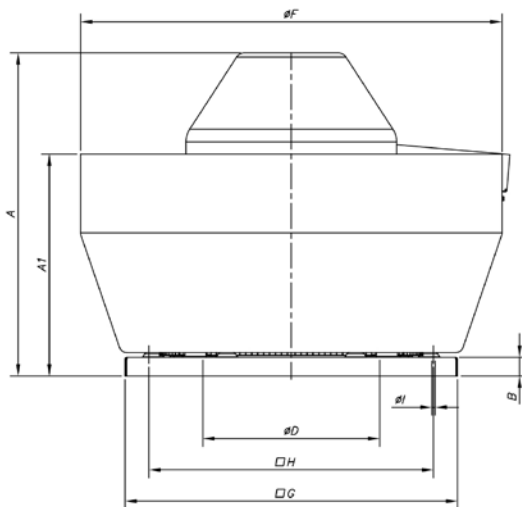

	A	A1	B	øD*	øF	G	H	øl
CVT-200	472	296	20	250	530	450	360	12
CVT-225	490	296	20	250	530	450	360	12
CVT-250	562	248	30	355	700	560	450	12
CVT-315	612	373	30	355	700	560	450	12
CVT-400	689	473	40	500	900	710	590	12
CVT-450	705	474	40	500	900	710	590	12
CVT-500	772	545	40	630	1100	900	750	14
CVT-560	957	678	40	710	1295	1100	900	14
CVT-630	1017	676	40	710	1295	1100	900	14

* Recommended nominal tube diameter

Characteristic curves

Q= Flow rate in m³/h, m³/s and cfm

Pe= Static pressure in mm H₂O, Pa and inwg

4M/4T=1500 r/min

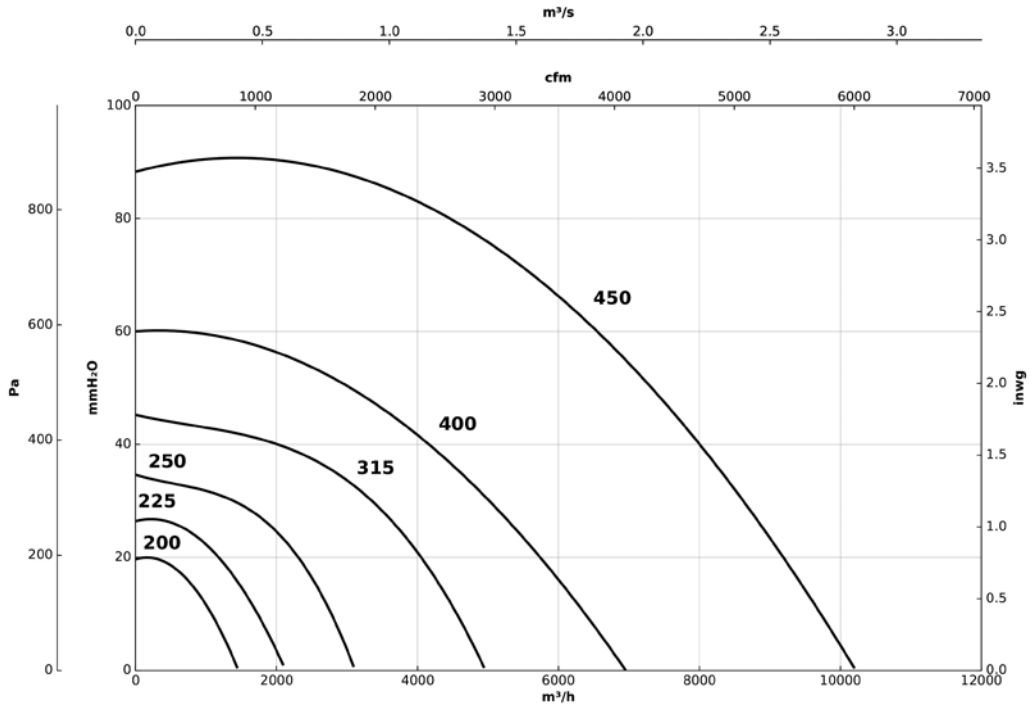

6T=1000 r/min

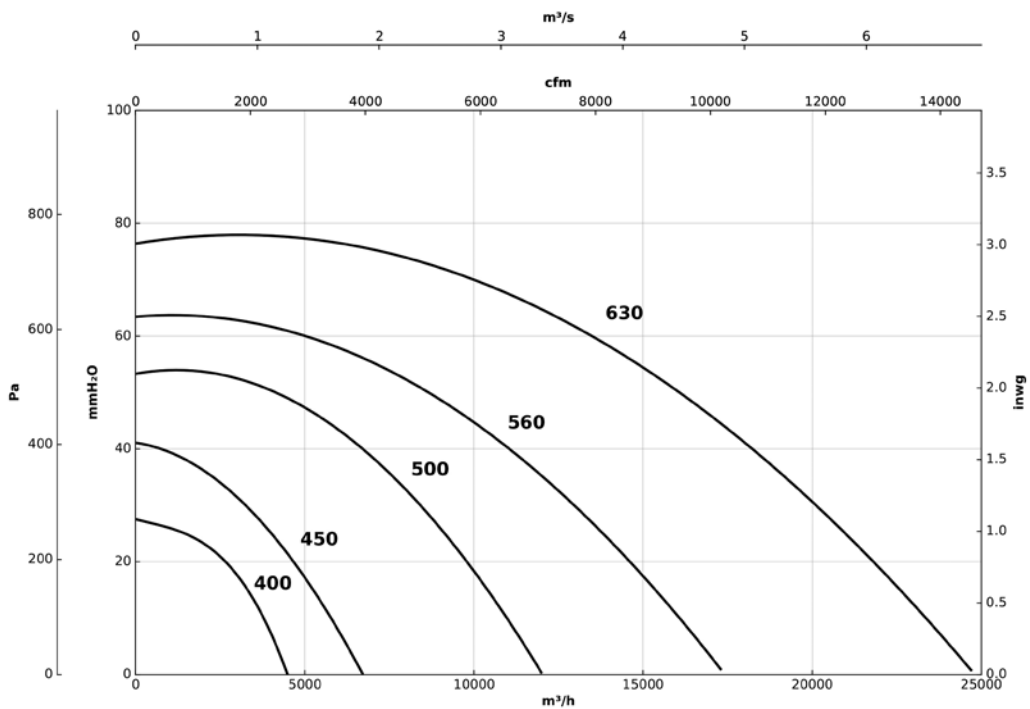

Sound pressure variation depending on distance

The noise level may vary depending on the roof or tile structure.

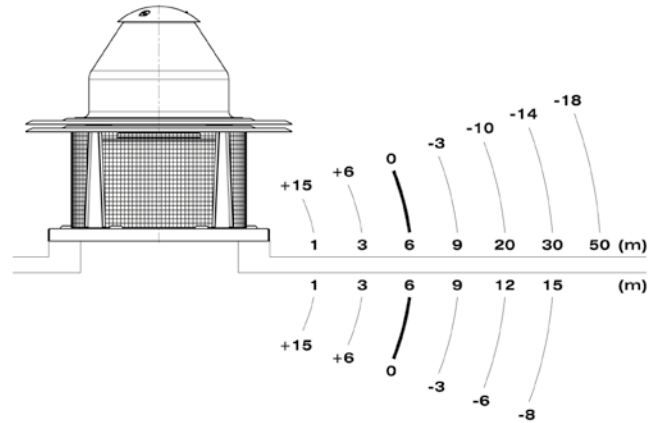

Application example

Extract fans suitable for use in industrial kitchens

For the correct application of standard:

- C.T.E. Código Técnico de la Edificación (Technical Building Code). Basic Document SI on fire safety. Basic Document HS on health and safety.

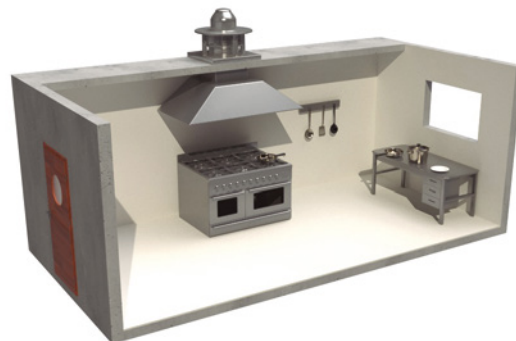

Accessories



INT



C2V



RM



VSD3/A-RFT
- VSD1/A-RFM



B



BAC



MS



PA



BS



BSS



PT



S



SI-PIR



SI-TEMP+HUMEDAD



SI-PRESIÓN



SI-FUENTE DE ALIMENTACIÓN



SI-VENT



SI-PRESOSTATO

CVT/EC

Centrifugal roof fans with vertical air outlet, with EC Technology IE5 motor



Fan:

- Support base in galvanized steel sheet.
- Backward curved impeller made of galvanized sheet steel.
- Bird protection grid.
- Aluminum rain cover.
- Airflow direction from motor to impeller.

Motor:

- High efficiency EC Technology motors with integrated electronics, regulated by 0-10 V or 4-20 mA.
- IE5 efficiency motors, class F and IP55 protection.
- Single-phase 230 V 50/60 Hz.
- Working temperature: -25 °C +60 °C.

- External sensor: compatible with temperature, humidity, air quality or CO sensor.
- Equipment preconfigured in constant pressure mode with 100 Pa set point.

Finish:

- Anti-corrosive in galvanized steel sheet and aluminum.



EC TECHNOLOGY MOTOR with integrated electronics



EC CONTROL Supplied as an optional accessory

EC CONTROL: Supplied as an optional accessory. Control panel for ventilation systems with EC Technology motors with the electronics integrated in the motor itself. With the following characteristics:

- CPC: Constant pressure control.
- CFC: Constant flow control.
- DAY / NIGHT: Double pressure setpoint adjustment according to time of day.

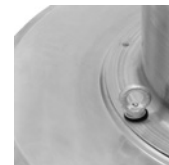

Support for roof-mounting



Order code

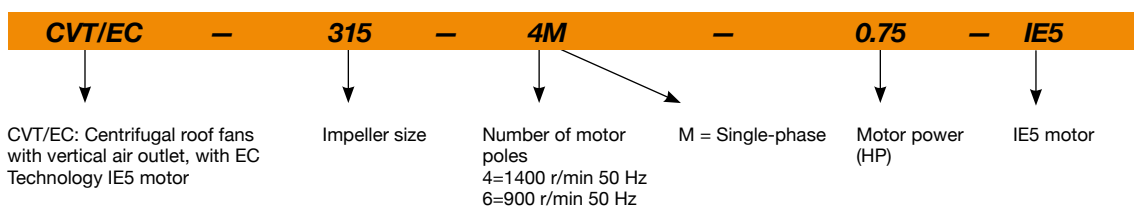

Technical characteristics

Model	Speed (r/min)	Maximum admissible current (A) 230V	Max. electric power (kW)	Maximum flow rate (m³/h)	Sound pressure level dB (A)		Approx. weight (Kg)
					Inlet	Exhaust	
CVT/EC-315-4M-0.75 IE5	1380	4.8	0.55	4950	48	54	39
CVT/EC-400-6M-0.55 IE5	900	3.4	0.37	4500	44	50	56
CVT/EC-450-6M-0.55 IE5	900	3.4	0.37	6900	47	54	59



Erp. (Energy Related Products)

Information on Directive 2009/125/EC can be downloaded from the SODECA website or the QuickFan selector programme.

Acoustic characteristics

The indicated values are determined by measuring the sound pressure level and sound power in dB(A) obtained in a free field at a distance equivalent to twice the size of the fan plus the impeller diameter, with a minimum of 1.5 m.

Sound power spectrum Lw(A) in dB(A) per Hz frequency band

Values measured at inlet with maximum flow rate (Qmax)

	63	125	250	500	1000	2000	4000	8000
315-4M	50	56	62	62	65	68	59	53
400-6M	46	52	58	58	61	64	55	49
450-6M	50	57	62	62	66	65	58	53

Values measured at exhaust with maximum flow rate (Qmax)

	63	125	250	500	1000	2000	4000	8000
315-4M	49	61	69	71	72	72	84	58
400-6M	45	57	65	67	68	68	60	52
450-6M	50	62	70	72	73	70	63	55

Dimensions mm

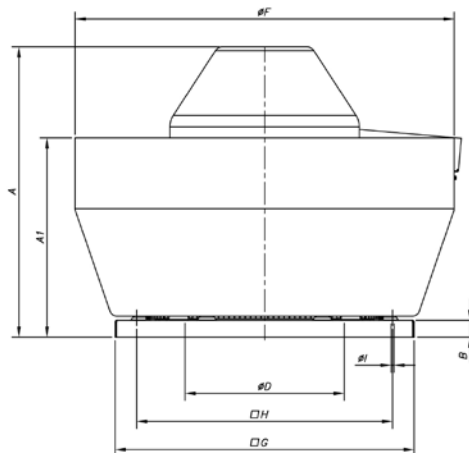

	A	A1	B	øD*	øF	G	H	øl
CVT/EC-315-4M	612	373	30	355	700	560	450	12
CVT/EC-400-6M	689	473	40	500	900	710	590	12
CVT/EC-450-6M	705	474	40	500	900	710	590	12

* Recommended nominal tube diameter

Characteristic curves

Q= Flow rate in m³/h, m³/s and cfm

Pe= Static pressure in mm H₂O, Pa and inwg

CVT/EC-315-4M

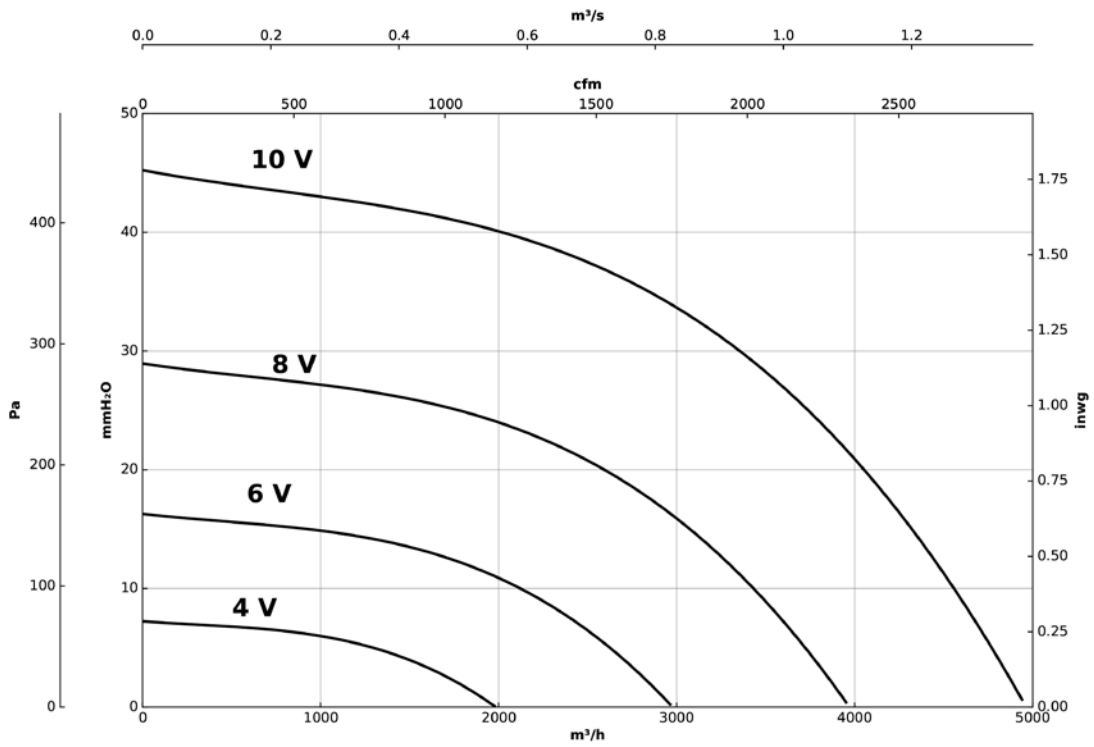

CVT/EC-400-6M

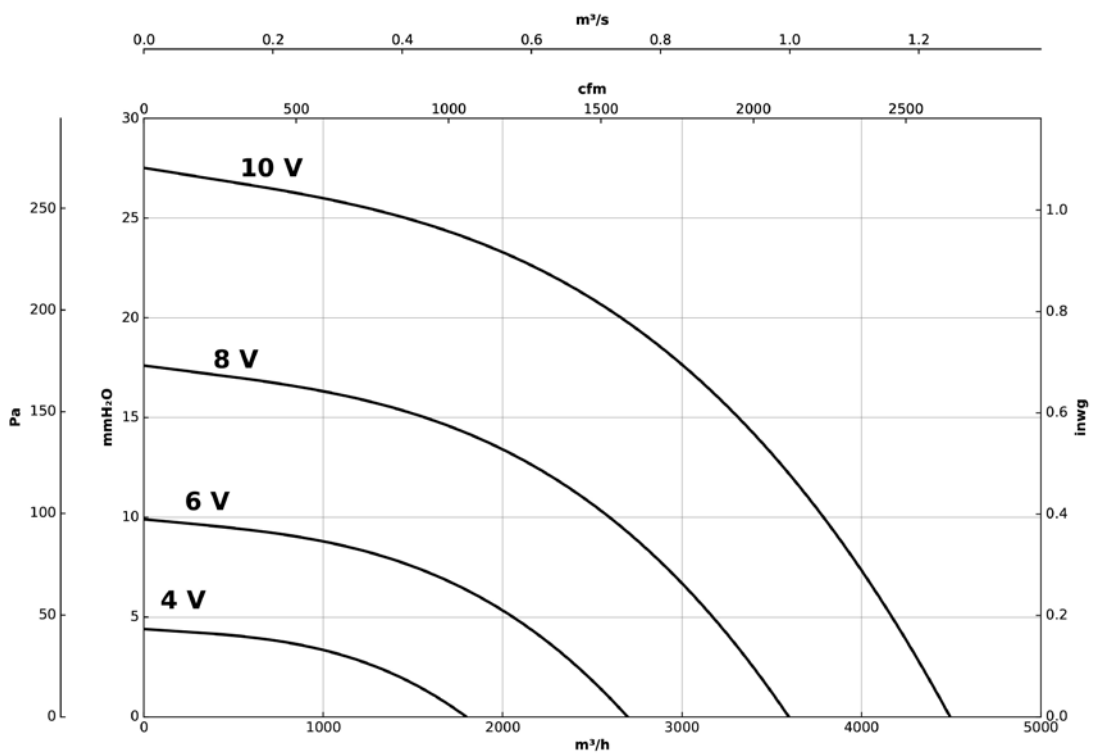

Characteristic curves

Q= Flow rate in m³/h, m³/s and cfm

Pe= Static pressure in mm H₂O, Pa and inwg

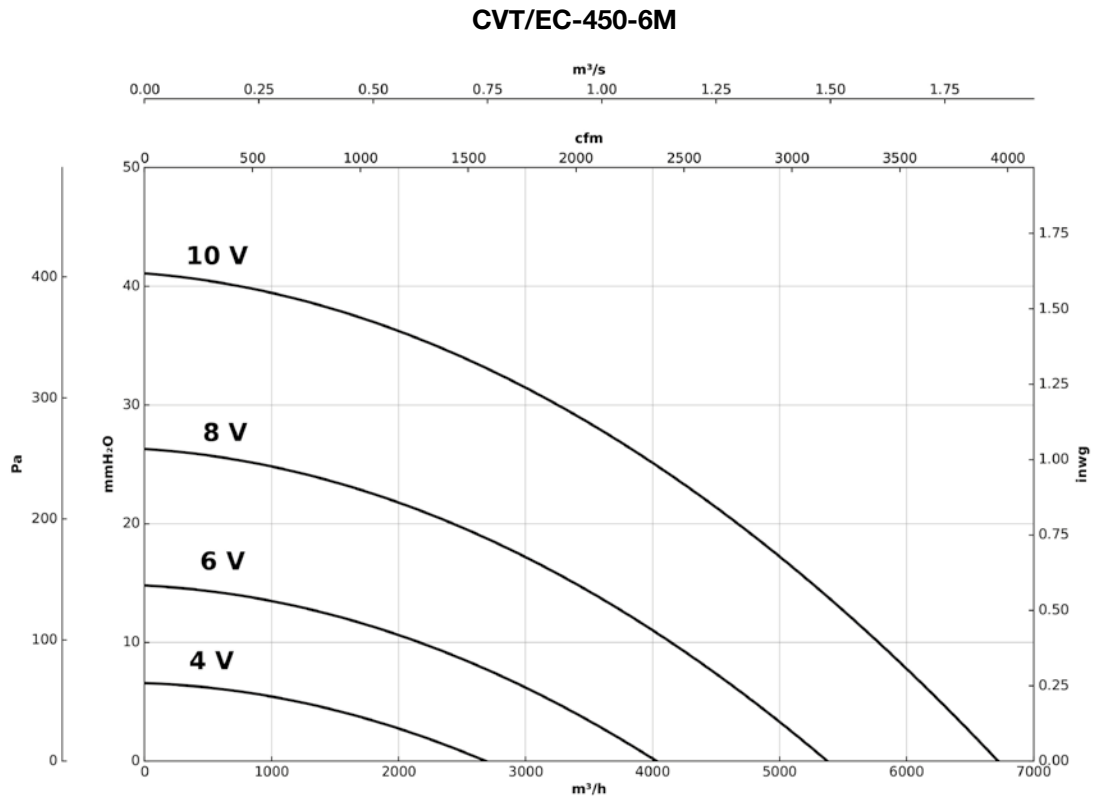

Accessories

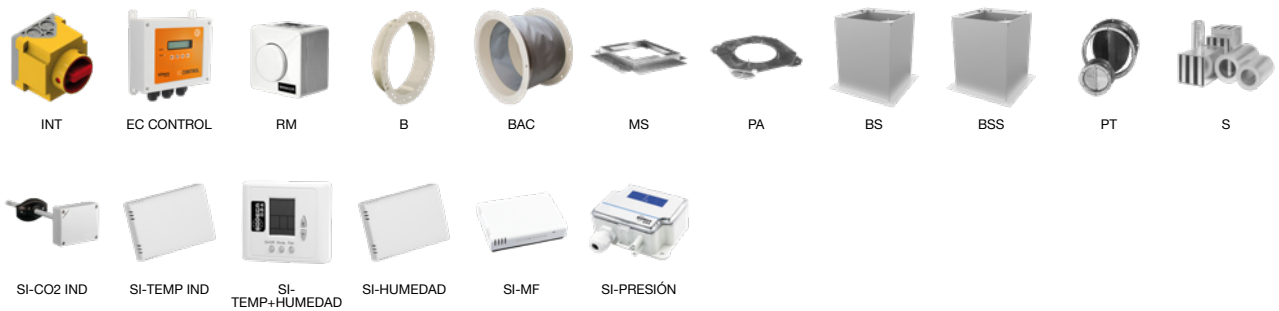

KIT BOXPDS



Pressurisation equipment for evacuation routes, designed according to the European standard EN 12101-6



Fire evacuation route pressurisation systems designed in accordance with the European standard EN 12101-6. The KIT BOXPDS automatically regulates the airflow and is able to maintain the 50 Pa of overpressure even in the presence of leaks in the installation. The system is able to maintain the overpressure (Pressure criteria) and reach the 90% of the required flow rate within 3 seconds after opening or closing a door (Airflow criteria).

Including test certification for dynamic performance, electromagnetic compatibility, environmental resistance and IP protection degree.

Utility model: ES 1 226 660 U.

KIT BOXPDS

- Consists of the BOXPDS control panel, external control panel, a CJHCH ventilation unit and a DAMPER BOX with built-in optical smoke detector.

BOXPDS

- Variable frequency drive.
- High precision differential pressure probe.
- Electrical panel with magneto thermal protections and general power supply failure indication.
- Electronic control for alarm management, maintenance, ModBUS RTU port for connection to BMS (Building Management Systems) and control by DAMPER BOX.
- Certified power supply with batteries to ensure power supply to control equipment in the event of a power failure.
- Includes time programming to activate daily ventilation.

Control panel:

- External control panel with touch screen for real time pressure display, system configuration and calibration, status lights and manual system activation.
- Auto-Manual-Off selector.
- Fire alarm reset selector.
- Test selector.

On request:

- Automatic switching system for backup fan (see KIT BOXPDS II series).

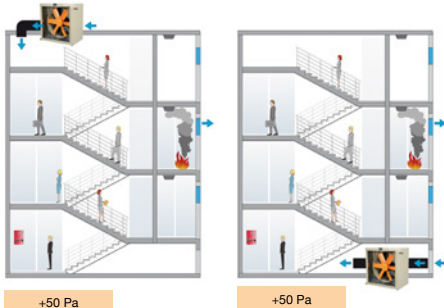

- Easy to install.
- A compact, autonomous solution.
- Easy start-up.
- Safe, functional installation.

Order code

KIT BOXPDS — **800** — **4T** — **5.5**

KIT BOXPDS: Pressurisation equipment for evacuation routes, designed according to the European standard EN 12101-6
 KIT BOXPDS II: Pressurisation equipment for evacuation routes with standby fan, designed according to the European standard EN 12101-6

Impeller diameter in cm

Number of motor poles
 4=1400 r/min 50 Hz

T = Three-phase

Motor power (HP)

Technical characteristics

Model	Speed (r/min)	Power supply (V) (Hz)	Maximum admissible current (A)	Installed power (kW)	Maximum flow rate (m ³ /h)	Sound pressure level dB (A)	Approx. weight (Kg)
			400V				
KIT BOXPDS-710-4T-1.5 IE3	1400	380-480 V 50/60 Hz	4.75	1.1	19770	75	188
KIT BOXPDS-710-4T-2 IE3	1430	380-480 V 50/60 Hz	6.25	1.5	21090	75	191
KIT BOXPDS-710-4T-3 IE3	1445	380-480 V 50/60 Hz	8.20	2.2	23970	78	200
KIT BOXPDS-800-4T-3 IE3	1445	380-480 V 50/60 Hz	8.20	2.2	27940	79	208
KIT BOXPDS-800-4T-4 IE3	1445	380-480 V 50/60 Hz	10.05	3.0	32720	80	210
KIT BOXPDS-800-4T-5.5 IE3	1440	380-480 V 50/60 Hz	12.65	4.0	37440	81	215
KIT BOXPDS-900-4T-7.5 IE3	1440	380-480 V 50/60 Hz	15.20	5.5	47550	88	309
KIT BOXPDS-900-4T-10 IE3	1455	380-480 V 50/60 Hz	20.30	7.5	53120	89	326
KIT BOXPDS-1000-4T-10 IE3	1455	380-480 V 50/60 Hz	20.30	7.5	58560	90	334
KIT BOXPDS-1000-4T-15 IE3	1460	380-480 V 50/60 Hz	28.30	11.0	68000	91	366
KIT BOXPDS-1000-4T-20 IE3	1460	380-480 V 50/60 Hz	36.60	15.0	71850	92	377

May be supplied with the KIT BOXPDS II for standby fan (a second impulsion unit is added to the KIT BOXPDS).

Dimensions mm

KIT BOXPDS

	A	B	C	D	E	F	G	H	I	J	K	L	O
KIT BOXPDS-710/800	1314	300	1000	976.5	326.5	1000	650	995	600	850	650	850	1000
KIT BOXPDS-900/1000	1540	300	1200	1102	326.5	1200	750	1195	800	1050	750	1050	1200

Dimensions mm

	BOXPDS			DAMPER BOX			CJHCH		
	C	B	I	E	J	H	O	K	L
BOXPDS-710/800	1000	300	600	326.5	850	995	1000	650	850
BOXPDS-900/1000	1200	300	800	326.5	1050	1195	1200	750	1050

Application example

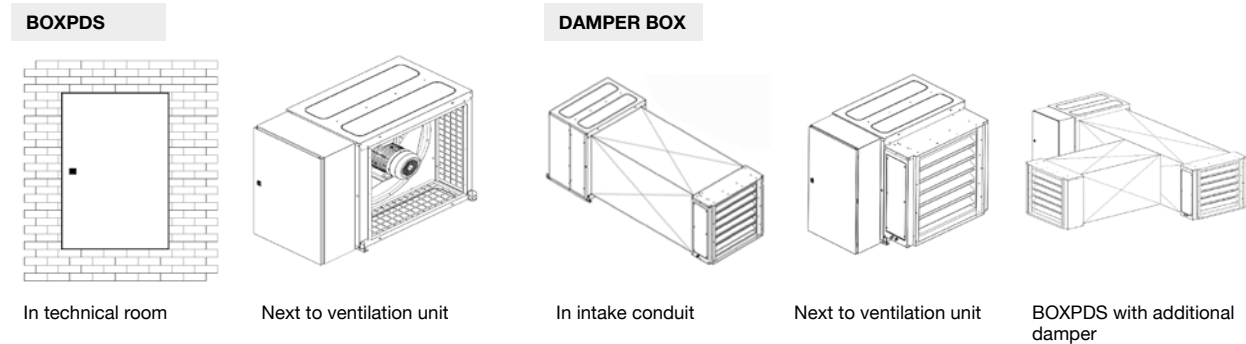

2 DAMPERS can be used by installing two inlets away from the fan, so that if smoke is detected at one inlet it will close and the second damper will be kept open to ensure the entry of clean air into the space to be protected (smoke-free evacuation route).

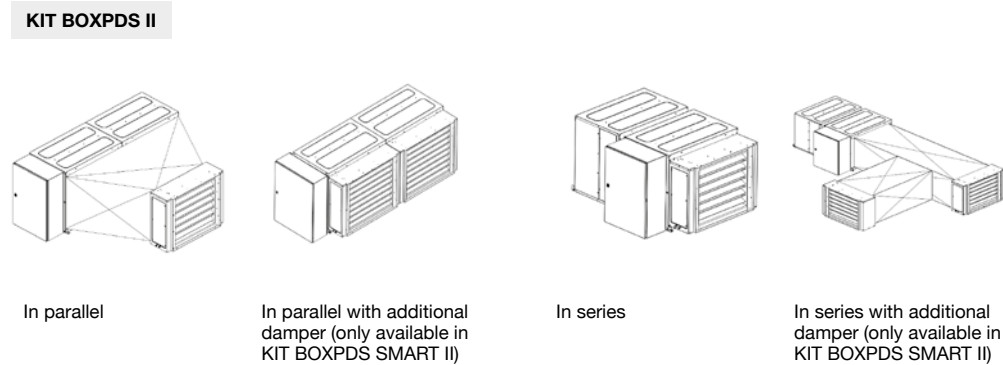

Accessories



PDS LOBBY CONTROL



DAMPER BOX

KIT BOXPDS SMART



Pressurisation equipment for evacuation routes with advanced control, designed according to the European standard EN 12101-6

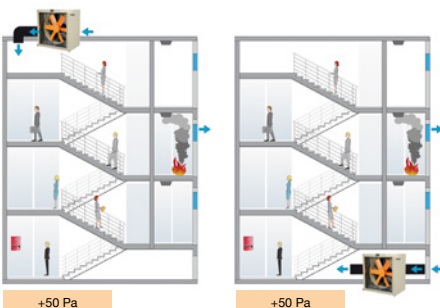

Fire evacuation route pressurisation systems designed in accordance with the European standard EN 12101-6. The KIT BOXPDS SMART automatically regulates the airflow and is able to maintain the 50 Pa of overpressure even in the presence of leaks in the installation. The system is able to maintain the overpressure (Pressure criteria) and reach the 90% of the required flow rate within 3 seconds after opening or closing a door (Airflow criteria).

Including test certification for dynamic performance, electromagnetic compatibility, environmental resistance and IP protection degree.

Utility model: ES 1 226 660 U.

KIT BOXPDS SMART

- Device with advanced control, consisting of a BOXPDS SMART control panel, an external control panel, a CJHCH ventilation unit and a DAMPER BOX SMART with integrated optical smoke detector.

BOXPDS SMART

- Variable frequency drive.
- High precision differential pressure probe.
- Electrical panel with magneto thermal protections and general power supply failure indication.
- Electronic control for alarm management, maintenance, ModBUS RTU port for connection to BMS (Building Management Systems) and control by DAMPER BOX SMART.
- Certified power supply with batteries

to ensure power supply to control equipment in the event of a power failure.

- Quick set up for intuitive configuration.
- Possibility of controlling 3 motorised air intakes of the DAMPER BOX SMART, HATCH or WALL type.
- Smoke detector with automatic reset.
- Pressurisation or despressurisation/ extraction mode.
- Possibility of connecting several pressure sensors for large stairwells and choosing the control mode: Maximum, minimum or average.
- External sensors connection: Humidity, temperature and wind.
- Includes time programming to activate daily ventilation.

Control panel:

- External control panel with touch screen for real time pressure display, system configuration and calibration, status lights and manual system activation.
- Possibility of connecting up to 3 KIT BOXPDS SMART.
- Auto-Manual-Off selector.
- Fire alarm reset selector.
- Test selector.

On request:

- Automatic switching system for backup fan (see KIT BOXPDS SMART II series).



- Easy to install.
- A compact, autonomous solution.
- Easy start-up.
- Safe, functional installation.

Order code

KIT BOXPDS SMART

800

4T

5.5

KIT BOXPDS SMART: Pressurisation equipment for evacuation routes with advanced control, designed according to the European standard EN 12101-6
 KIT BOXPDS SMART II: Pressurisation equipment for evacuation routes with advanced control and standby fan, designed according to the European standard EN 12101-6

Impeller diameter in cm

Number of motor poles
 4=1400 r/min 50 Hz

T = Three-phase

Motor power (HP)

Technical characteristics

Model	Speed (r/min)	Power supply (V) (Hz)	Maximum admissible current (A)		Installed power (kW)	Maximum flow rate (m³/h)	Sound pressure level dB (A)	Approx. weight (Kg)
			400V					
KIT BOXPDS SMART-710-4T-1.5 IE3	1400	380-480 V 50/60 Hz	4.75		1.1	19770	75	188
KIT BOXPDS SMART-710-4T-2 IE3	1430	380-480 V 50/60 Hz	6.25		1.5	21090	75	196
KIT BOXPDS SMART-710-4T-3 IE3	1445	380-480 V 50/60 Hz	8.20		2.2	23970	78	205
KIT BOXPDS SMART-800-4T-3 IE3	1445	380-480 V 50/60 Hz	8.20		2.2	27940	79	213
KIT BOXPDS SMART-800-4T-4 IE3	1445	380-480 V 50/60 Hz	10.05		3.0	32720	80	215
KIT BOXPDS SMART-800-4T-5.5 IE3	1440	380-480 V 50/60 Hz	12.65		4.0	37440	81	220
KIT BOXPDS SMART-900-4T-7.5 IE3	1440	380-480 V 50/60 Hz	15.20		5.5	47550	88	314
KIT BOXPDS SMART-900-4T-10 IE3	1455	380-480 V 50/60 Hz	20.30		7.5	53120	89	331
KIT BOXPDS SMART-1000-4T-10 IE3	1455	380-480 V 50/60 Hz	20.30		7.5	58560	90	339
KIT BOXPDS SMART-1000-4T-15 IE3	1460	380-480 V 50/60 Hz	28.30		11.0	68000	91	371
KIT BOXPDS SMART-1000-4T-20 IE3	1460	380-480 V 50/60 Hz	36.60		15.0	71850	92	382

May be supplied with the KIT BOXPDS SMART II for standby fan (a second impulsion unit is added to the KIT BOXPDS SMART).

Dimensions mm

KIT BOXPDS SMART

	A	B	C	D	E	F	G	H	I	J	K	L	O
KIT BOXPDS SMART-710/800	1400	400	1000	1000	350	1000	650	995	600	850	650	850	1000
KIT BOXPDS SMART-900/1000	1600	400	1200	1125	350	1200	750	1195	800	1050	750	1050	1200

BOXPDS SMART			DAMPER BOX SMART			CJHCH					
	C	B	I		E	J	H		O	K	L
BOXPDS SMART-710/800	1000	400	600	DAMPER BOX SMART 71/80	350	850	995	CJHCH-71/80	1000	650	850
BOXPDS SMART-900/1000	1200	400	800	DAMPER BOX SMART 90/100	350	1050	1195	CJHCH-90/100	1200	750	1050

Application example

BOXPDS SMART

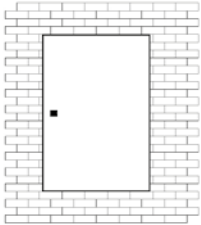

In technical room

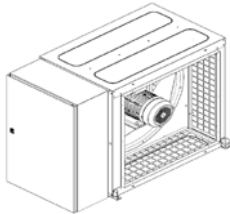

Next to ventilation unit

DAMPER BOX SMART

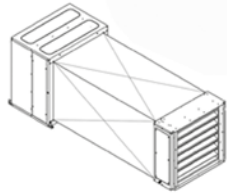

In intake conduit

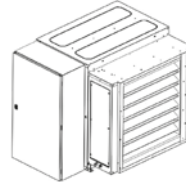

Next to ventilation unit

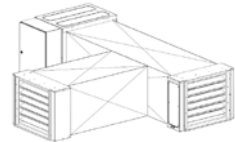

BOXPDS with additional damper

2 DAMPERS can be used by installing two inlets away from the fan, so that if smoke is detected at one inlet it will close and the second damper will be kept open to ensure the entry of clean air into the space to be protected (smoke-free evacuation route).

KIT BXPDS SMART II

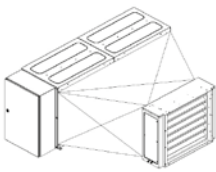

In parallel

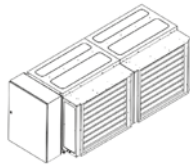

In parallel with additional damper (only available in KIT BXPDS SMART II)

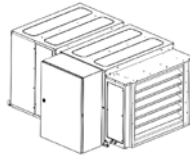

In series

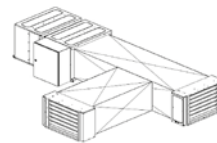

In series with additional damper (only available in KIT BXPDS SMART II)

Accessories



PDS LOBBY CONTROL



DAMPER BOX SMART

HATCH PDS



Equipment for pressurizing evacuation routes in the event of fire, designed according to the European standard EN 12101-6

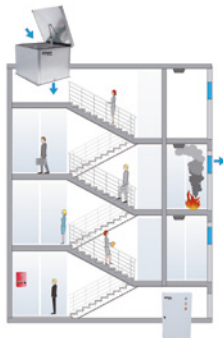

+50 Pa

HATCH PDS

- Consists of a HATCH ventilation unit with motorized damper opening and a BOXPDS control panel.
- An extremely robust structure that is able to withstand severe weather changes.
- Equipment structure made of anti-corrosive galvanised sheet steel.
- Designed to ensure watertightness.
- Thermal insulation to avoid losses of hot air in winter.
- Adaptable skirting for correct, easy installation on the roof.
- Built-in analog smoke detector.
- Utility model: ES 1 226 660 U.

Opening system:

- Motorised opening arm, with encapsulated IP65 mechanism.
- System reinforced and guaranteed with more than 11,000 cycles.
- Snow load SL 1000.

Fan:

- HCT series extract fans.
- Tubular casing in sheet steel with polyester resin anti-corrosive treatment.
- Cast aluminium impellers.

Motor:

- Motors with IE3 efficiency for powers equal to or greater than 0.75 kW, except single-phase, 2-speed and 8-pole.
- Class F motors with ball bearings and IP55 protection.
- Three-phase 230/400 V 50 Hz (up to 4 kW) and 400/690 V 50 Hz (powers greater than 4 kW).
- Working temperature: -25 °C +50 °C.

Finish:

- Anti-corrosive in galvanized steel sheet.

On request:

- Fitted with F300 and F400 rated fans.
- Reversible pressurisation equipment for smoke exhaust in case of need.
- Polyester resin anti-corrosive paint finish.

BOXPDS

- Variable frequency drive.
- High precision differential pressure probe.
- Electrical panel with magneto thermal protections and general power supply failure indication.
- Electronic control for alarm management, maintenance, ModBUS RTU port for connection to BMS (Building Management Systems).
- Certified power supply with batteries to ensure power supply to control equipment in the event of a power failure.
- Includes time programming to activate daily ventilation.

Control panel:

- External control panel for real time pressure display, alarm pilots and manual activation of the system.



Order code

HATCH PDS	—	80	—	4T	—	5.5	—	G
↓		↓		↓		↓		↓
HATCH PDS: Equipment for pressurizing evacuation routes in the event of fire, designed according to the European standard EN 12101-6		Size		Number of motor poles 2=2900 r/min 50 Hz 4=1400 r/min 50 Hz 6=900 r/min 50 Hz	T = Three-phase	Motor power (HP)		Finish G=galvanised P=painted in special colour

Technical characteristics

Model	Speed (r/min)	Maximum admissible current (A)			Installed power (kW)	Blade tilt angle (°)	Maximum flow rate (m³/h)	Sound pressure level dB (A)		Approx. weight (Kg)
		230V	400V	690V				Inlet	Exhaust	
HATCH PDS-40-2T-1 IE3	2850	2.80	1.62		0.75	16	6100	62	62	184
HATCH PDS-40-2T-1.5 IE3	2880	4.03	2.34		1.10	20	7040	61	61	188
HATCH PDS-45-2T-2 IE3	2880	5.34	3.07		1.50	16	9400	61	61	193
HATCH PDS-45-2T-3 IE3	2840	7.32	4.21		2.20	22	11325	61	61	194
HATCH PDS-50-2T-4 IE3	2880	10.00	5.77		3.00	16	13860	66	66	206
HATCH PDS-50-2T-5.5 IE3	2900	13.00	7.50		4.00	20	15918	66	66	222
HATCH PDS-56-2T-5.5 IE3	2870	13.00	7.50		4.00	16	18820	68	68	226
HATCH PDS-56-2T-7.5 IE3	2910		10.10	5.86	5.50	22	22510	68	68	237
HATCH PDS-56-4T-2 IE3	1440	5.41	3.11		1.50	36	15025	54	54	205
HATCH PDS-63-4T-3 IE3	1425	7.93	4.56		2.20	32	22170	58	58	262
HATCH PDS-63-4T-4 IE3	1430	10.70	6.15		3.00	38	24240	59	59	271
HATCH PDS-63-6T-1 IE3	940	3.36	1.93		0.75	38	15890	48	48	252
HATCH PDS-80-4T-3 IE3	1425	7.93	4.56		2.20	12	25460	65	65	280
HATCH PDS-80-4T-4 IE3	1430	10.70	6.15		3.00	16	30270	64	64	289
HATCH PDS-80-4T-5.5 IE3	1440	13.90	8.00		4.00	18	32770	63	63	295
HATCH PDS-80-4T-7.5 IE3	1460		10.30	5.97	5.50	26	39640	63	63	311
HATCH PDS-80-6T-1.5 IE3	945	4.68	2.69		1.10	18	21470	53	53	279
HATCH PDS-80-6T-2 IE3	945	6.43	3.70		1.50	26	25970	54	54	288
HATCH PDS-90-4T-7.5 IE3	1460		10.30	5.97	5.50	18	46140	67	67	392
HATCH PDS-90-4T-10 IE3	1460		13.90	8.06	7.50	22	50140	66	66	403
HATCH PDS-90-4T-15 IE3	1460		20.90	12.10	11.00	30	59390	68	68	456
HATCH PDS-90-6T-3 IE3	950	9.08	5.22		2.20	24	34000	56	56	365
HATCH PDS-90-6T-4 IE3	970	12.00	6.91		3.00	30	38910	59	59	391
HATCH PDS-100-4T-10 IE3	1460		13.90	8.06	7.50	16	57420	69	69	413
HATCH PDS-100-4T-15 IE3	1460		20.90	12.10	11.00	22	66300	69	69	466
HATCH PDS-100-6T-5.5 IE3	970	15.60	8.99		4.00	26	47780	60	60	413
HATCH PDS-100-6T-7.5 IE3	970		11.20	6.49	5.50	32	53520	62	62	420

* The noise level values are pressures in dB(A) measured at a distance of 10 metres in a free field.

Technical characteristics of the dynamic exhaust system based on standards EN-12101-3

Model	Approval	Motor insulation class	Durability	Temperature room temperature	Wind load	Snow load
	(°C)				(Pa)	(Pa)
HATCH PDS	-	Class F	RE 11000	-25	WL 200	SL 1000

Acoustic characteristics

Sound power spectrum Lw(A) in dB(A) per Hz frequency band

Values measured at inlet with maximum flow rate

	63	125	250	500	1000	2000	4000	8000
40-2-1	48	64	76	84	89	87	83	76
40-2-1.5	47	63	75	83	88	86	82	75
45-2-2	47	60	74	86	87	86	82	74
45-2-3	47	64	74	81	88	86	83	75
50-2-4	58	74	84	91	92	89	88	89
50-2-5.5	58	74	84	91	92	89	88	89
56-2-5.5	53	66	84	92	94	93	88	81
56-2-7.5	53	66	84	92	94	93	88	81
56-4-2	52	64	73	79	79	79	73	65
63-4-3	56	68	77	83	83	83	77	69
63-4-4	57	69	78	84	84	84	78	70
63-6-1	49	59	69	73	74	72	65	57
80-4-3	55	71	84	91	91	88	82	74
80-4-4	54	70	83	90	90	87	81	73
80-4-5.5	53	69	82	89	89	86	80	72
80-4-7.5	53	69	82	89	89	86	80	72
80-6-1.5	53	68	75	78	79	76	70	62
80-6-2	59	69	75	79	80	78	73	65
90-4-7.5	59	75	86	92	93	91	86	78
90-4-10	58	74	85	91	92	90	85	77
90-4-15	60	76	87	93	94	92	87	79
90-6-3	52	67	78	82	82	78	71	63
90-6-4	60	70	80	85	85	82	76	68
100-4-10	64	80	87	94	95	93	89	81
100-4-15	71	83	87	93	94	94	91	83
100-6-5.5	57	72	82	85	86	83	75	67
100-6-7.5	59	74	84	87	88	85	77	69

Values measured at exhaust with maximum flow rate

	63	125	250	500	1000	2000	4000	8000
40-2-1	48	64	76	84	89	87	83	76
40-2-1.5	47	63	75	83	88	86	82	75
45-2-2	47	60	74	86	87	86	82	74
45-2-3	47	64	74	81	88	86	83	75
50-2-4	58	74	84	91	92	89	88	89
50-2-5.5	58	74	84	91	92	89	88	89
56-2-5.5	53	66	84	92	94	93	88	81
56-2-7.5	53	66	84	92	94	93	88	81
56-4-2	52	64	73	79	79	79	73	65
63-4-3	56	68	77	83	83	83	77	69
63-4-4	57	69	78	84	84	84	78	70
63-6-1	49	59	69	73	74	72	65	57
80-4-3	55	71	84	91	91	88	82	74
80-4-4	54	70	83	90	90	87	81	73
80-4-5.5	53	69	82	89	89	86	80	72
80-4-7.5	53	69	82	89	89	86	80	72
80-6-1.5	53	68	75	78	79	76	70	62
80-6-2	59	69	75	79	80	78	73	65
90-4-7.5	59	75	86	92	93	91	86	78
90-4-10	58	74	85	91	92	90	85	77
90-4-15	60	76	87	93	94	92	87	79
90-6-3	52	67	78	82	82	78	71	63
90-6-4	60	70	80	85	85	82	76	68
100-4-10	64	80	87	94	95	93	89	81
100-4-15	71	83	87	93	94	94	91	83
100-6-5.5	57	72	82	85	86	83	75	67
100-6-7.5	59	74	84	87	88	85	77	69

Dimensions mm

HATCH PDS

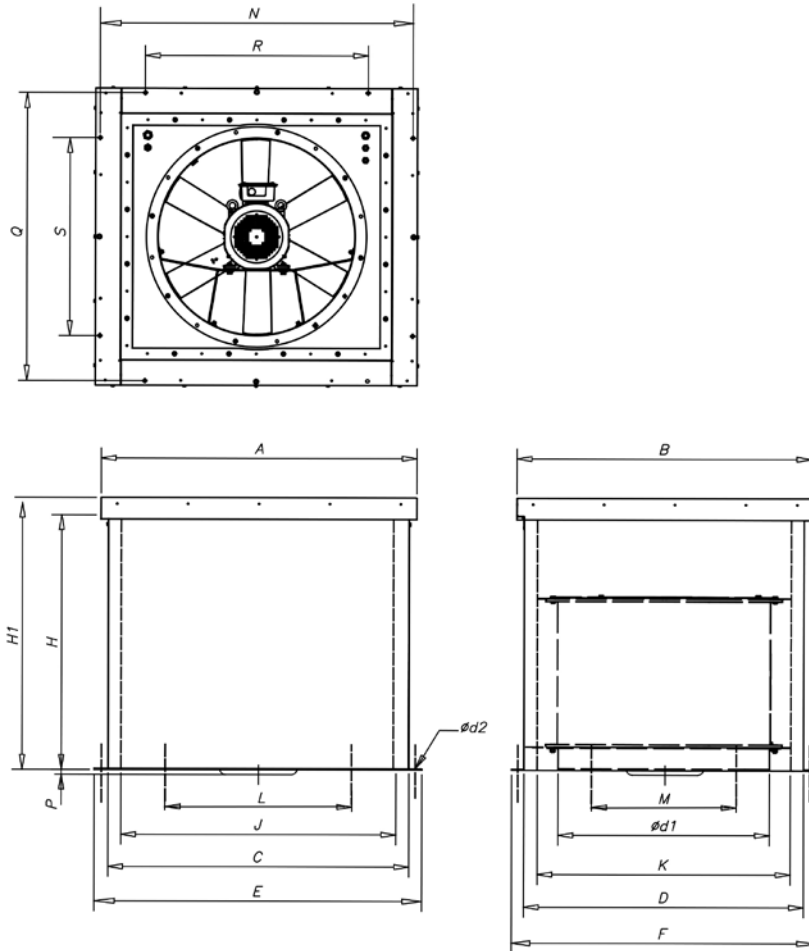

	A	B	C	D	Ød1	E	F	H	H1	J	K	L	M	N	P	Q	R	S	Ød2
HATCH/PDS-40	1100	1000	1020	920	400	1100	1000	900	1000	900	800	700	600	1065	-	965	700	600	13
HATCH/PDS-45	1100	1000	1020	920	450	1100	1000	900	1000	900	800	700	600	1065	-	965	700	600	13
HATCH/PDS-50	1100	1000	1020	920	500	1100	1000	900	1000	900	800	700	600	1065	-	965	700	600	13
HATCH/PDS-56	1100	1000	1020	920	560	1100	1000	900	1000	900	800	700	600	1065	-	965	700	600	13
HATCH/PDS-63	1300	1200	1220	1120	630	1300	1200	900	1000	1100	1000	900	800	1265	-	1165	900	800	13
HATCH/PDS-80	1300	1200	1220	1120	800	1300	1200	900	1000	1100	1000	900	800	1265	-	1165	900	800	13
HATCH/PDS-90	1500	1400	1420	1320	900	1500	1400	900	1000	1300	1200	1100	1000	1465	-	1365	1100	1000	13
HATCH/PDS-90-4T-15	1500	1400	1420	1320	900	1500	1400	900	1000	1300	1200	1100	1000	1465	38	1365	1100	1000	13
HATCH/PDS-100	1500	1400	1420	1320	1000	1500	1400	900	1000	1300	1200	1100	1000	1465	-	1365	1100	1000	13
HATCH/PDS-100-4T-15	1500	1400	1420	1320	1000	1500	1400	900	1000	1300	1200	1100	1000	1465	80	1365	1100	1000	13

BOXPDS

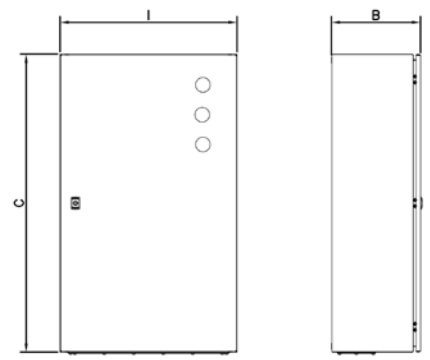

	I	B	C	Size
BOXPDS (0.75kW...4kW)	600	300	1000	1
BOXPDS (5.5kW...15kW)	800	300	1200	2



KIT BOXSMART KIT BOXSMART II

Pressurisation system for stairs or evacuation routes. Maintains a differential pressure of 50 Pa in a single stage, designed according to the European standard EN 12101-6



The correct operation of the pressurisation systems depends not only on their sound design, but also on the correct regulation performed by the system. For this reason, it is extremely important to have calibrated, high precision regulation elements that will permit both situations present in the event of a fire to be maintained simultaneously, quickly and stably.

KIT BOXSMART

- Staircase overpressure kit, consisting of a control panel (BOXSMART), a drive unit (CJHCH or CJBD), for the pressurization of stairs and evacuation routes, and an integrated control of motorized flaps with smoke detector (Compatible with DAMPER BOX SMART).

KIT BOXSMART II

- Overpressure kit with backup fan, consisting of a control panel (BOXSMART II), which incorporates an

automatic switching system to maintain overpressure in the event of failure of the main fan, and an integrated control of motorized flaps with smoke detector (Compatible with DAMPER BOX SMART).

CM-SMART: External control panel for firefighters

- The CM-SMART indicates the system status and provides firefighters with the option of manually turning the system on or off via its selector switch. We recommend that this panel be installed at the main entry point to the protected area.
- This unit is not included in the KIT BOXSMART.
- The BOXSMART and BOXSMART II models are compatible with CM-SMART.



- Easy to install.
- A compact, autonomous solution.
- Easy start-up.
- Safe, functional installation.

Order code

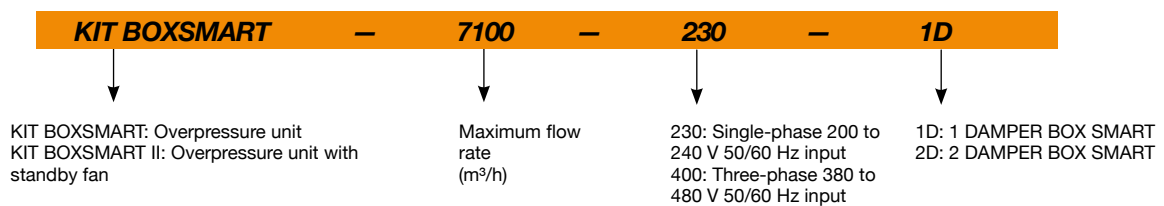

Technical characteristics

Model	Power (kW)	Power supply (V) (Hz)	Outlet (V)	Maximum flow rate (m ³ /h)	Impulsion unit
KIT BOXSMART-2880-230V-1D	0.37	200 a 240 V 50/60 Hz	230 V 50/60 Hz	2880	CJBD-2828-4M 1/2
KIT BOXSMART-7100-230V-1D	0.37	200 a 240 V 50/60 Hz	230 V 50/60 Hz	7100	CJHCH-45-4T-0.5 IE3
KIT BOXSMART-7800-230V-1D	1.10	200 a 240 V 50/60 Hz	230 V 50/60 Hz	7800	CJBD-3333-6T 1 1/2
KIT BOXSMART-12900-230V-1D	0.75	200 a 240 V 50/60 Hz	230 V 50/60 Hz	12900	CJHCH-56-4T-1 IE3
KIT BOXSMART-17000-230V-1D	1.10	200 a 240 V 50/60 Hz	230 V 50/60 Hz	17000	CJHCH-63-4T-1.5 IE3
KIT BOXSMART-7800-400V-1D	1.10	380 a 480 V 50/60 Hz	400 V 50/60 Hz	7800	CJBD-3333-6T 1 1/2
KIT BOXSMART-12900-400V-1D	0.75	380 a 480 V 50/60 Hz	400 V 50/60 Hz	12900	CJHCH-56-4T-1 IE3
KIT BOXSMART-17000-400V-1D	1.10	380 a 480 V 50/60 Hz	400 V 50/60 Hz	17000	CJHCH-63-4T-1.5 IE3

Technical characteristics

Model	Power	Power supply	Outlet	Maximum flow rate	Impulsion unit
	(kW)	(V) (Hz)	(V)	(m ³ /h)	
KIT BOXSMART-21100-400V-1D	1.50	380 a 480 V 50/60 Hz	400 V 50/60 Hz	22100	CJHCH-71-4T-2 IE3
KIT BOXSMART-2880-230V-2D	0.37	200 a 240 V 50/60 Hz	230 V 50/60 Hz	2880	CJBD-2828-4M 1/2
KIT BOXSMART-7100-230V-2D	0.37	200 a 240 V 50/60 Hz	230 V 50/60 Hz	7100	CJHCH-45-4T-0.5 IE3
KIT BOXSMART-7800-230V-2D	1.10	200 a 240 V 50/60 Hz	230 V 50/60 Hz	7800	CJBD-3333-6T 1 1/2
KIT BOXSMART-12900-230V-2D	0.75	200 a 240 V 50/60 Hz	230 V 50/60 Hz	12900	CJHCH-56-4T-1 IE3
KIT BOXSMART-17000-230V-2D	1.10	200 a 240 V 50/60 Hz	230 V 50/60 Hz	17000	CJHCH-63-4T-1.5 IE3
KIT BOXSMART-7800-400V-2D	1.10	380 a 480 V 50/60 Hz	400 V 50/60 Hz	7800	CJBD-3333-6T 1 1/2
KIT BOXSMART-12900-400V-2D	0.75	380 a 480 V 50/60 Hz	400 V 50/60 Hz	12900	CJHCH-56-4T-1 IE3
KIT BOXSMART-17000-400V-2D	1.10	380 a 480 V 50/60 Hz	400 V 50/60 Hz	17000	CJHCH-63-4T-1.5 IE3
KIT BOXSMART-21100-400V-2D	1.50	380 a 480 V 50/60 Hz	400 V 50/60 Hz	22100	CJHCH-71-4T-2 IE3

* The output power is reduced by 20% when the equipment is operating in the lower electrical power range. The same models, except the FLAP models, may be supplied with the KIT BOXSMART II for standby fan (a second impulsion unit is added to the KIT BOXSMART).

Dimensions mm

CJBD

	A	B	C	D	E	F	G	K	L
CJBD-2828	550	575	600	479	504	104	177	330	294
CJBD-3333	650	650	700	554	604	105	198	392	347

CJHCH

	A	C	D1
CJHCH-45	700	550	565
CJHCH-56/63	825	550	690
CJHCH-71	1000	650	850

Application example

Overpressure smoke control method

This system uses pressurisation by injecting air into spaces that are used as evacuation routes in the event of a fire, including stairwells, corridors, passageways, lifts, etc., especially in tall buildings with high occupancy.

The method is based on using air speed and over pressure to create a barrier, preventing smoke from entering evacuation routes.

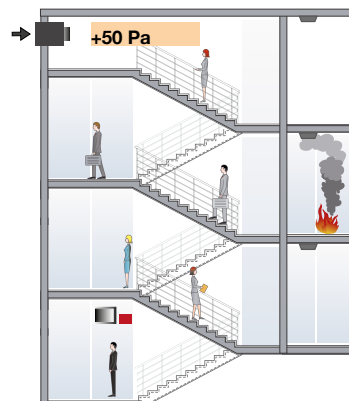

BOXSMART

Control panel for a fan

BOXSMART II

Control panel with standby fan



- The BOXSMART control panel includes:
- Variable frequency drive programmed at 50 Pa and highly accurate differential pressure probe.
 - External connection for the control panel to be used exclusively by firefighters.
 - Magnetic thermal switch.
 - Status indicator lamp: Ready, Alarm, Fire and Run.
 - Built-in control panel with TEST selector for maintenance and selector to be used exclusively by firefighters 0-AUTO-MANUAL.
 - Operating procedures in safe mode in the case of failure of the differential pressure probe and automatic reset of the system in case of failure.
 - Connection of status signals using free power contacts (FAULT, START and FIRE ACTIVATION) and connection to BMS systems via RTU Modbus for monitoring the equipment.
 - Memory of the last activation state for greater security, resettable from the RESET selector on the control panel or by external signal.
 - External connection for daily ventilation use through SI-CALENDAR accessory.

- Metal casing with lock with key and with IP66 protection.
- Capable of managing asynchronous motors, IPM or RM.
- Ready to operate and perform its function of pressure control.
- Only the power supply, the impulsion fan and the fire signal need to be connected.
- Different input voltage ranges and power on demand.
- Integrated control of motorized flaps with smoke detector (Compatible with DAMPER BOX SMART).

Options:

- BOXSMART EC: control panel for an EC motor fan.
- BOXSMART: control box for a fan.
- BOXSMART II: control panel with backup fan.
- BOXSMART FLAP: control panel with damper fan.

Order code

BOXSMART	—	1.1	—	230	—	M	—	1D
↓		↓		↓		↓		↓
BOXSMART: Control panel for a fan BOXSMART II: Control panel with standby fan		Power (kW)		Input voltage		M: Single-phase input T: Three-phase input		1D: 1 DAMPER BOX SMART 2D: 2 DAMPER BOX SMART

Technical characteristics and dimensions

BOXSMART								
Model	Power (kW)	Power supply (V) (Hz)	Outlet (V)	Max. Output current (A)	Size	Measurements (length x width x depth)	Approx. weight (Kg)	
BOXSMART-0.37-230V 50/60Hz-M-T-1D	0.37	200 a 240 V 50/60 Hz	230 V 50/60 Hz	2.3	2	400x500x250	11	
BOXSMART-0.75-230V 50/60Hz-M-T-1D	0.75	200 a 240 V 50/60 Hz	230 V 50/60 Hz	4.3	2	400x500x250	11	
BOXSMART-1.5-230V 50/60Hz-T-T-1D	1.50	200 a 240 V 50/60 Hz	230 V 50/60 Hz	7.0	2	400x500x250	11	
BOXSMART-0.75-400V 50/60Hz-T-T-1D	0.75	380 a 480 V 50/60 Hz	400 V 50/60 Hz	2.2	2	400x500x250	11	
BOXSMART-1.5-400V 50/60Hz-T-T-1D	1.50	380 a 480 V 50/60 Hz	400 V 50/60 Hz	4.1	2	400x500x250	11	
BOXSMART-2.2-400V 50/60Hz-T-T-1D	2.20	380 a 480 V 50/60 Hz	400 V 50/60 Hz	5.8	3	400x600x250	18	
BOXSMART-4-400V 50/60Hz-T-T-1D	4.00	380 a 480 V 50/60 Hz	400 V 50/60 Hz	9.5	3	400x600x250	18	

Technical characteristics and dimensions

BOXSMART

Model	Power (kW)	Power supply (V) (Hz)	Outlet (V)	Max. Output current (A)	Size	Measurements (length x width x depth)	Approx. weight (Kg)
BOXSMART-5.5-400V 50/60Hz-T-T-1D	5.50	380 a 480 V 50/60 Hz	400 V 50/60 Hz	14.0	4	500x700x250	21
BOXSMART-7.5-400V 50/60Hz-T-T-1D	7.50	380 a 480 V 50/60 Hz	400 V 50/60 Hz	18.0	4	500x700x250	21
BOXSMART-11-400V 50/60Hz-T-T-1D	11.00	380 a 480 V 50/60 Hz	400 V 50/60 Hz	24.0	4	500x700x250	22
BOXSMART-0.37-230V 50/60Hz-M-T-2D	0.37	200 a 240 V 50/60 Hz	230 V 50/60 Hz	2.3	3	400x600x250	11
BOXSMART-0.75-230V 50/60Hz-M-T-2D	0.75	200 a 240 V 50/60 Hz	230 V 50/60 Hz	4.3	3	400x600x250	11
BOXSMART-1.5-230V 50/60Hz-T-T-2D	1.50	200 a 240 V 50/60 Hz	230 V 50/60 Hz	7.0	3	400x600x250	11
BOXSMART-0.75-400V 50/60Hz-T-T-2D	0.75	380 a 480 V 50/60 Hz	400 V 50/60 Hz	2.2	3	400x600x250	11
BOXSMART-1.5-400V 50/60Hz-T-T-2D	1.50	380 a 480 V 50/60 Hz	400 V 50/60 Hz	4.1	3	400x600x250	11
BOXSMART-2.2-400V 50/60Hz-T-T-2D	2.20	380 a 480 V 50/60 Hz	400 V 50/60 Hz	5.8	4	500x700x250	18
BOXSMART-4-400V 50/60Hz-T-T-2D	4.00	380 a 480 V 50/60 Hz	400 V 50/60 Hz	9.5	4	500x700x250	18
BOXSMART-5.5-400V 50/60Hz-T-T-2D	5.50	380 a 480 V 50/60 Hz	400 V 50/60 Hz	14.0	5	600x800x250	21
BOXSMART-7.5-400V 50/60Hz-T-T-2D	7.50	380 a 480 V 50/60 Hz	400 V 50/60 Hz	18.0	5	600x800x250	21
BOXSMART-11-400V 50/60Hz-T-T-2D	11.00	380 a 480 V 50/60 Hz	400 V 50/60 Hz	24.0	5	600x800x250	22

BOXSMART II

For systems with a standby fan. The fans never operate simultaneously.

Model	Power (kW)	Power supply (V) (Hz)	Outlet (V)	Max. Output current (A)	Size	Measurements (length x width x depth)	Approx. weight (Kg)
BOXSMART II-0.37-230V 50/60Hz-M-T-1D	0.37	200 a 240 V 50/60 Hz	230 V 50/60 Hz	2.3	4	500x700x250	11
BOXSMART II-0.75-230V 50/60Hz-M-T-1D	0.75	200 a 240 V 50/60 Hz	230 V 50/60 Hz	4.3	4	500x700x250	11
BOXSMART II-1.5-230V 50/60Hz-T-T-1D	1.50	200 a 240 V 50/60 Hz	230 V 50/60 Hz	7.0	4	500x700x250	11
BOXSMART II-0.75-400V 50/60Hz-T-T-1D	0.75	380 a 480 V 50/60 Hz	400 V 50/60 Hz	2.2	4	500x700x250	11
BOXSMART II-1.5-400V 50/60Hz-T-T-1D	1.50	380 a 480 V 50/60 Hz	400 V 50/60 Hz	4.1	4	500x700x250	11
BOXSMART II-2.2-400V 50/60Hz-T-T-1D	2.20	380 a 480 V 50/60 Hz	400 V 50/60 Hz	5.8	5	600x800x250	18
BOXSMART II-4-400V 50/60Hz-T-T-1D	4.00	380 a 480 V 50/60 Hz	400 V 50/60 Hz	9.5	5	600x800x250	18
BOXSMART II-5.5-400V 50/60Hz-T-T-1D	5.50	380 a 480 V 50/60 Hz	400 V 50/60 Hz	14.0	6	800x800x250	21
BOXSMART II-7.5-400V 50/60Hz-T-T-1D	7.50	380 a 480 V 50/60 Hz	400 V 50/60 Hz	18.0	6	800x800x250	21
BOXSMART II-11-400V 50/60Hz-T-T-1D	11.00	380 a 480 V 50/60 Hz	400 V 50/60 Hz	24.0	6	800x800x250	22
BOXSMART II-0.37-230V 50/60Hz-M-T-2D	0.37	200 a 240 V 50/60 Hz	230 V 50/60 Hz	2.3	4	500x700x250	11
BOXSMART II-0.75-230V 50/60Hz-M-T-2D	0.75	200 a 240 V 50/60 Hz	230 V 50/60 Hz	4.3	4	500x700x250	11
BOXSMART II-1.5-230V 50/60Hz-T-T-2D	1.50	200 a 240 V 50/60 Hz	230 V 50/60 Hz	7.0	4	500x700x250	11
BOXSMART II-0.75-400V 50/60Hz-T-T-2D	0.75	380 a 480 V 50/60 Hz	400 V 50/60 Hz	2.2	4	500x700x250	11
BOXSMART II-1.5-400V 50/60Hz-T-T-2D	1.50	380 a 480 V 50/60 Hz	400 V 50/60 Hz	4.1	4	500x700x250	11
BOXSMART II-2.2-400V 50/60Hz-T-T-2D	2.20	380 a 480 V 50/60 Hz	400 V 50/60 Hz	5.8	5	600x800x250	18
BOXSMART II-4-400V 50/60Hz-T-T-2D	4.00	380 a 480 V 50/60 Hz	400 V 50/60 Hz	9.5	5	600x800x250	18
BOXSMART II-5.5-400V 50/60Hz-T-T-2D	5.50	380 a 480 V 50/60 Hz	400 V 50/60 Hz	14.0	6	800x800x250	21
BOXSMART II-7.5-400V 50/60Hz-T-T-2D	7.50	380 a 480 V 50/60 Hz	400 V 50/60 Hz	18.0	6	800x800x250	21
BOXSMART II-11-400V 50/60Hz-T-T-2D	11.00	380 a 480 V 50/60 Hz	400 V 50/60 Hz	24.0	6	800x800x250	22

Connections

*All connections are made at the top section of the panel.

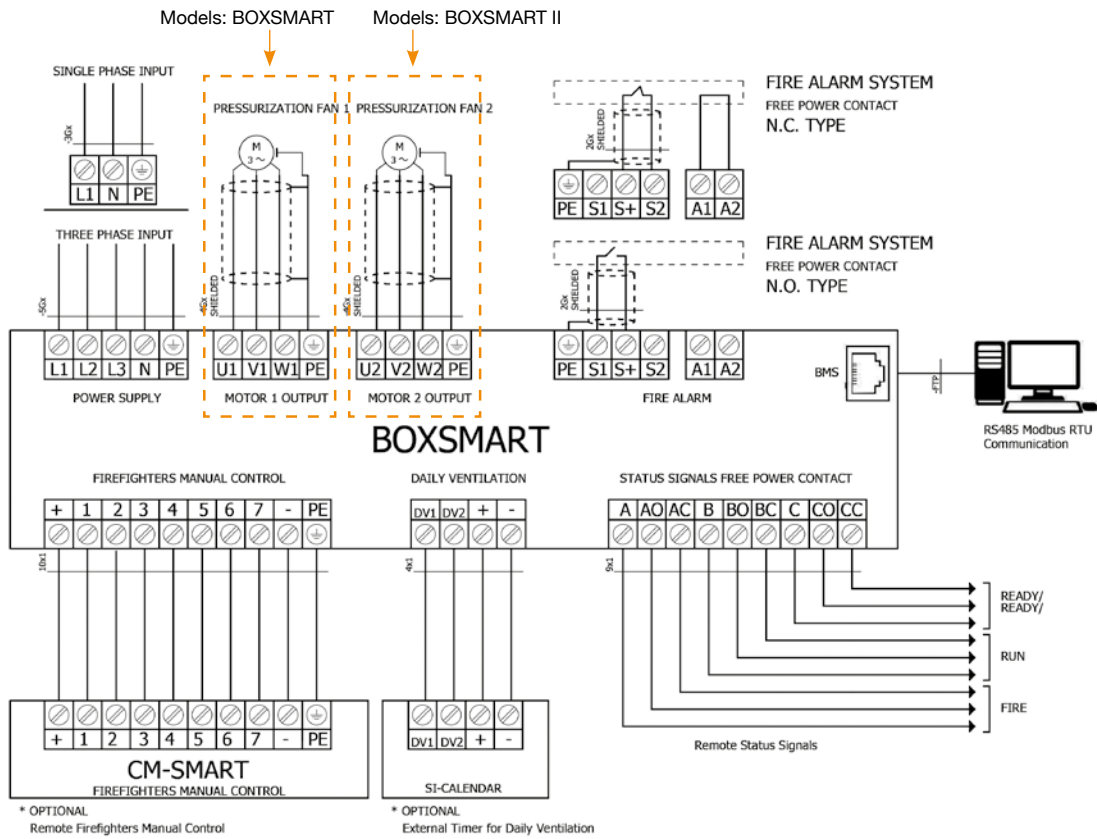

Accessories



CM-SMART



SI-CALENDAR



DAMPER BOX SMART

KIT BOXSMART EC



Pressurisation system for stairs or evacuation routes. Maintains a differential pressure of 50 Pa in a single stage, designed according to the European standard EN 12101-6



The correct operation of the pressurisation systems depends not only on their sound design, but also on the correct regulation performed by the system. For this reason, it is extremely important to have calibrated, high precision regulation elements that will permit both situations present in the event of a fire to be maintained simultaneously, quickly and stably.

Staircase overpressure kit, consisting of a control panel (BOXSMART EC) and a high-efficiency drive unit with EC Technology motors (CJK/EC).

CM-SMART: External control panel for firefighters

- The CM-SMART indicates the system status and provides firefighters with the option of manually turning the system on or off via its selector switch. We recommend that this panel be installed at the main entry point to the protected area.
- This unit is not included in the KIT BOXSMART EC.
- The BOXSMART EC model is compatible with CM-SMART.



- Easy to install.
- A compact, autonomous solution.
- Easy start-up.
- Safe, functional installation.

Order code

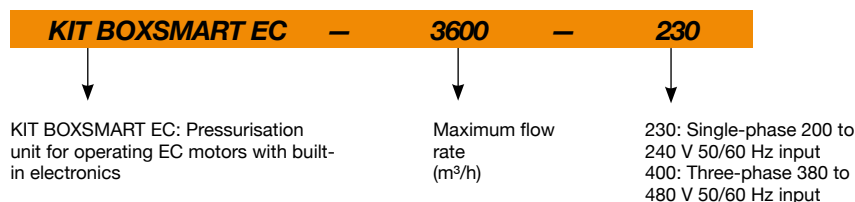

Technical characteristics

Model	Power (kW)	Power supply (V) (Hz)	Outlet (V)	Maximum flow rate (m ³ /h)	Impulsion unit
KIT BOXSMART EC-1900 - 230	0.2	200 a 240 V 50/60 Hz	230 V 50/60 Hz	1920	CJK/EC-310
KIT BOXSMART EC-3600 - 230	0.5	200 a 240 V 50/60 Hz	230 V 50/60 Hz	3640	CJK/EC-400
KIT BOXSMART EC-6500 - 400	1.1	380 a 480 V 50/60 Hz	400 V 50/60 Hz	6580	CJK/EC-500

* The output power is reduced by 20% when the equipment is operating in the lower electrical power range. The same models, except the FLAP models, may be supplied with the KIT BOXSMART II for standby fan (a second impulsion unit is added to the KIT BOXSMART).

Dimensions mm

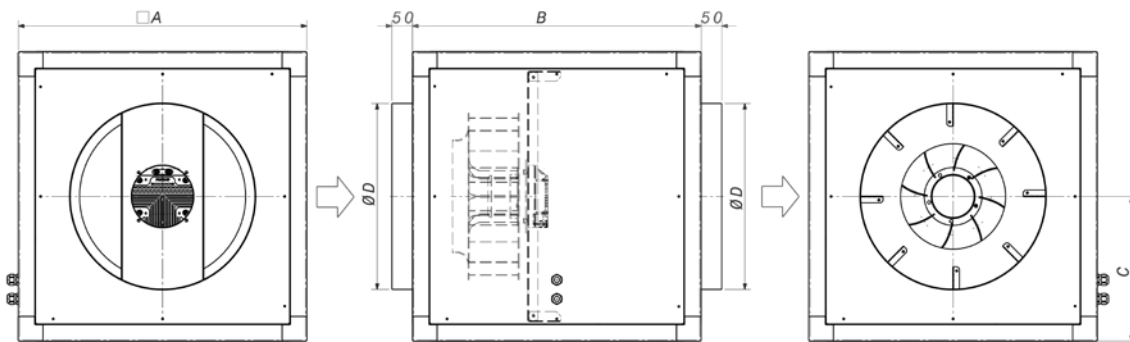

	A	B	C	ØD
CJK/EC-310	500	500	250	355
CJK/EC-400	700	700	350	450
CJK/EC-500	900	900	450	500

Application example

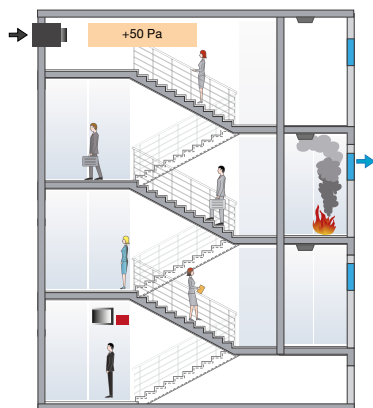

Overpressure smoke control method

This system uses pressurisation by injecting air into spaces that are used as evacuation routes in the event of a fire, including stairwells, corridors, passageways, lifts, etc., especially in tall buildings with high occupancy.

The method is based on using air speed and over pressure to create a barrier, preventing smoke from entering evacuation routes.

BOXSMART EC

Control panel for an EC motor fan



The BOXSMART EC control panel includes:

- Variable frequency drive programmed at 50 Pa and highly accurate differential pressure probe.
- External connection for the control panel to be used exclusively by firefighters.
- Magnetic thermal switch.
- Status indicator lamp: Ready, Alarm, Fire and Run.
- Built-in control panel with TEST selector for maintenance and selector to be used exclusively by firefighters 0-AUTO-MANUAL.
- Operating procedures in safe mode in the case of failure of the differential pressure probe and automatic reset of the system in case of failure.
- Connection of status signals using free power contacts (FAULT, START and FIRE ACTIVATION) and connection to BMS systems via RTU Modbus for monitoring the equipment.
- Memory of the last activation state for greater security, resettable from the RESET selector on the control panel or by external signal.

- External connection for daily ventilation use through SI-CALENDAR accessory.
- Metal casing with lock with key and with IP66 protection.
- Capable of managing asynchronous motors, IPM or RM.
- Ready to operate and perform its function of pressure control.
- Only the power supply, the impulsion fan and the fire signal need to be connected.
- Different input voltage ranges and power on demand.

Options:

- BOXSMART EC: control panel for an EC motor fan.
- BOXSMART: control box for a fan.
- BOXSMART II: control panel with backup fan.
- BOXSMART FLAP: control panel with damper fan.

Order code

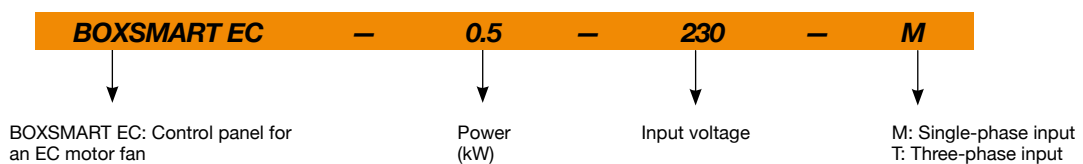

Technical characteristics

Model	Power (kW)	Power supply (V) (Hz)	Outlet (V)	Max. Output current (A)	Size	Measurements (length x width x depth)	Approx. weight (Kg)
BOXSMART EC-0.5-230V 50/60HZ-M-M	0.5	200 a 240 V 50/60 Hz	230 V 50/60 Hz	1.5	1	300x400x200	10
BOXSMART EC-1.1-400V 50/60HZ-T-T	1.1	380 a 480 V 50/60 Hz	400 V 50/60 Hz	2.0	1	300x400x200	10

Connections

*All connections are made at the top section of the panel.

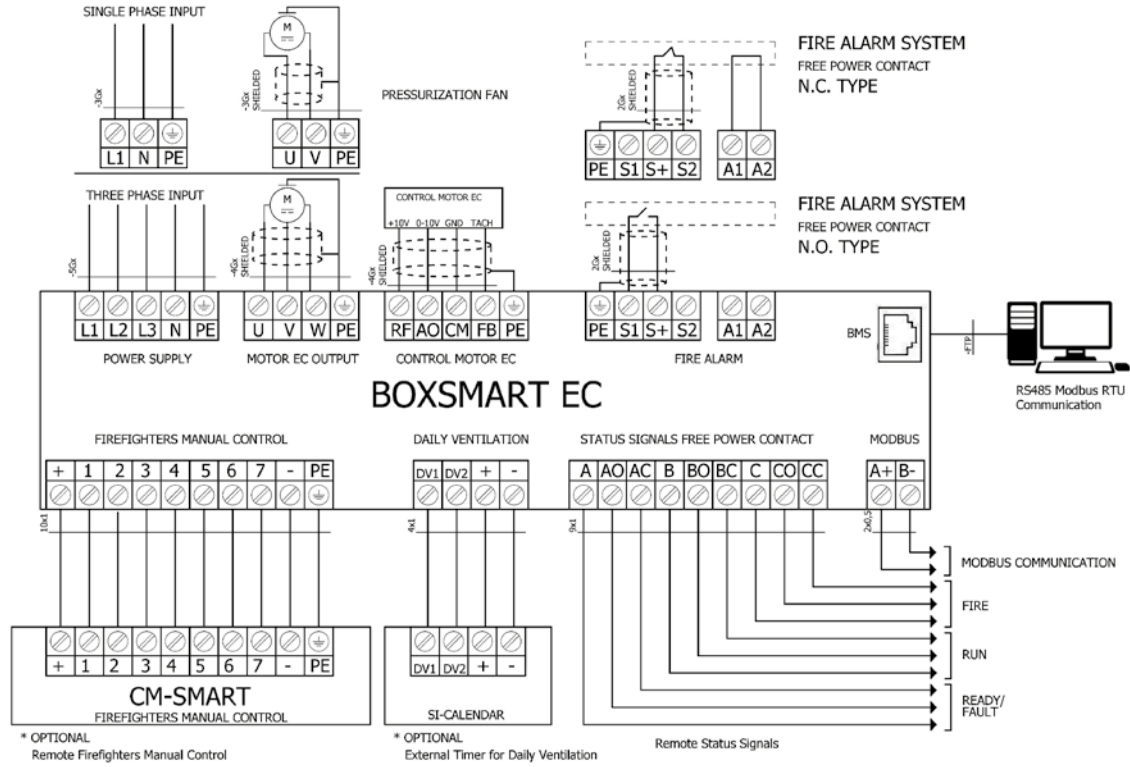

Accessories



CM-SMART



SI-CALENDAR

KIT BOXSMART FLAP



Pressurisation system for stairs or evacuation routes. Maintains a differential pressure of 50 Pa in a single stage, designed according to the European standard EN 12101-6



The correct operation of the pressurisation systems depends not only on their sound design, but also on the correct regulation performed by the system. For this reason, it is extremely important to have calibrated, high precision regulation elements that will permit both situations present in the event of a fire to be maintained simultaneously, quickly and stably.

Overpressure kit with hatch fan, consisting of a control panel (BOXSMART FLAP), which incorporates a control system for hatch fans (WALL or HATCH).

Optional CM-SMART accessory:

- External control panel for firefighters.
- Indicates the system status and provides firefighters with the option of manually turning the system on or off via its selector switch. We recommend that this panel be installed at the main entry point to the protected area.
- This unit is not included in the KIT BOXSMART FLAP.
- The BOXSMART FLAP models are compatible with CM-SMART FLAP.

On request:

- Customized panels for all powers according to project needs.



- Easy to install.
- A compact, autonomous solution.
- Easy start-up.
- Safe, functional installation.



Order code

KIT BOXSMART FLAP – 21100 – 400

KIT BOXSMART FLAP: Pressurisation unit with hatch fan

Maximum flow rate (m³/h)

400: Three-phase 380 to 480 V 50/60 Hz input

Technical characteristics

Model	Power (kW)	Power supply (V) (Hz)	Outlet (V)	Maximum flow rate (m ³ /h)	Impulsion unit
KIT BOXSMART FLAP-21100 - 400	1.5	380 a 480 V 50/60 Hz	400 V 50/60 Hz	21100	WALL/DUCT-71-4T IE3
KIT BOXSMART FLAP-25400 - 400	3.0	380 a 480 V 50/60 Hz	400 V 50/60 Hz	25400	HCT/HATCH-63-4T-4 IE3
KIT BOXSMART FLAP-41850 - 400	4.0	380 a 480 V 50/60 Hz	400 V 50/60 Hz	41850	WALL/DUCT-90-4T-5.5 IE3
KIT BOXSMART FLAP-52500 - 400	5.5	380 a 480 V 50/60 Hz	400 V 50/60 Hz	52500	HCT/HATCH-100-4T-7.5 IE3

* The output power is reduced by 20% when the equipment is operating in the lower electrical power range. The same models, except the FLAP models, may be supplied with the KIT BOXSMART II for standby fan (a second impulsion unit is added to the KIT BOXSMART).

Dimensions mm

HCT/HATCH

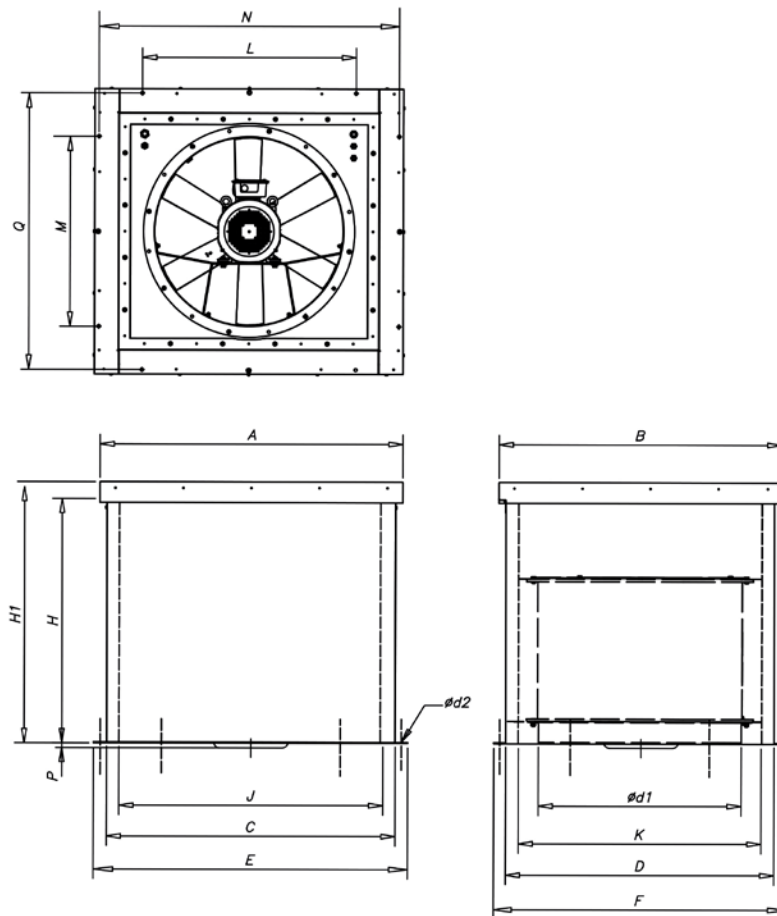

	A	B	C	D	Ød1	E	F	H	H1	J	K	L	M	N	P	Q	Ød2
HCT/HATCH-63	1300	1200	1220	1120	630	1300	1200	900	1000	1100	1000	900	800	1265	-	1165	13
HCT/HATCH-100	1500	1400	1420	1320	1000	1500	1400	900	1000	1300	1200	1100	1000	1465	-	1365	13

Dimensions mm

WALL/DUCT

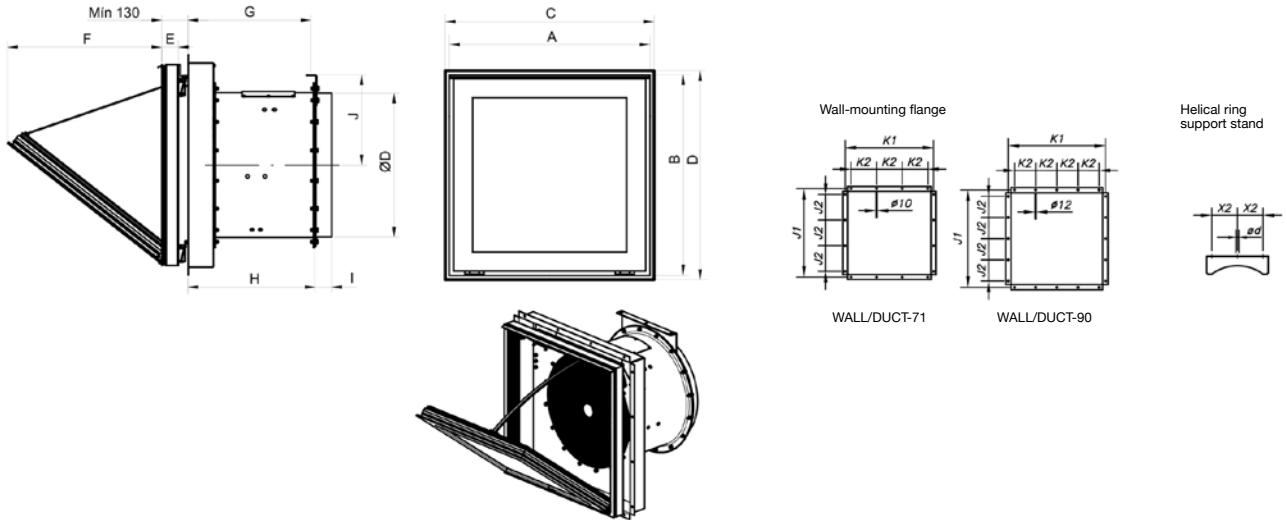

	A	B	C	Ød	D	ØD*	E	F	G	H	I	J	J1	J2	K1	K2	X2
WALL/DUCT-71	990	990	1000	13	1000	710	82	760	605	630	80	445	1050	300	1050	300	225
WALL/DUCT-90	1190	1190	1200	18	1200	900	82	790	605	630	100	550	1250	250	1250	250	280

* Recommended nominal tube diameter
(CxD) Nominal panel opening dimension.

Application example



Overpressure smoke control method

This system uses pressurisation by injecting air into spaces that are used as evacuation routes in the event of a fire, including stairwells, corridors, passageways, lifts, etc., especially in tall buildings with high occupancy.

The method is based on using air speed and over pressure to create a barrier, preventing smoke from entering evacuation routes.

BOXSMART FLAP

Control panel with damper fan



The BOXSMART FLAP control panel includes:

- Variable frequency drive programmed at 50 Pa and highly accurate differential pressure probe.
- External connection for the control panel to be used exclusively by firefighters.
- Magnetic thermal switch.
- Status indicator lamp: Ready, Alarm, Fire and Run.
- Built-in control panel with TEST selector for maintenance and selector to be used exclusively by firefighters 0-AUTO-MANUAL.
- Operating procedures in safe mode in the case of failure of the differential pressure probe and automatic reset of the system in case of failure.
- Connection of status signals using free power contacts (FAULT, START and FIRE ACTIVATION) and connection to BMS systems via RTU Modbus for monitoring the equipment.
- Memory of the last activation state for greater security, resettable from the RESET selector on the control panel or by external signal.

- External connection for daily ventilation use through SI-CALENDAR accessory.
- Metal casing with lock with key and with IP66 protection.
- Capable of managing asynchronous motors, IPM or RM.
- Ready to operate and perform its function of pressure control.
- Only the power supply, the impulsion fan and the fire signal need to be connected.
- Different input voltage ranges and power on demand.

Options:

- BOXSMART EC: control panel for an EC motor fan.
- BOXSMART: control box for a fan.
- BOXSMART II: control panel with backup fan.
- BOXSMART FLAP: control panel with damper fan.

Order code

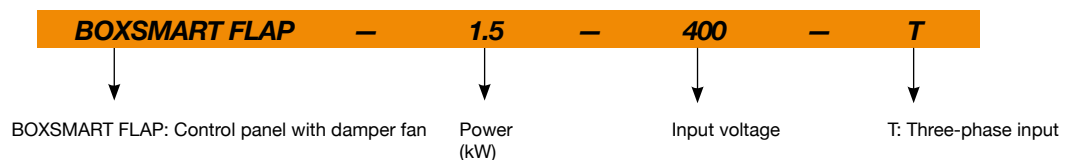

Technical characteristics

Model	Power (kW)	Power supply (V) (Hz)	Outlet (V)	Max. Output current (A)	Size	Measurements (length x width x depth)	Approx. weight (Kg)
BOXSMART FLAP-1.5-400V 50/60Hz-T-T	1.50	380 a 480 V 50/60 Hz	400 V 50/60 Hz	4.1	2	400x500x250	18
BOXSMART FLAP-4-400V 50/60Hz-T-T	4.00	380 a 480 V 50/60 Hz	400 V 50/60 Hz	9.5	3	400x600x250	20
BOXSMART FLAP-5.5-400V 50/60Hz-T-T	5.50	380 a 480 V 50/60 Hz	400 V 50/60 Hz	14.0	4	500x700x250	28

Connections

*All connections are made at the top section of the panel.

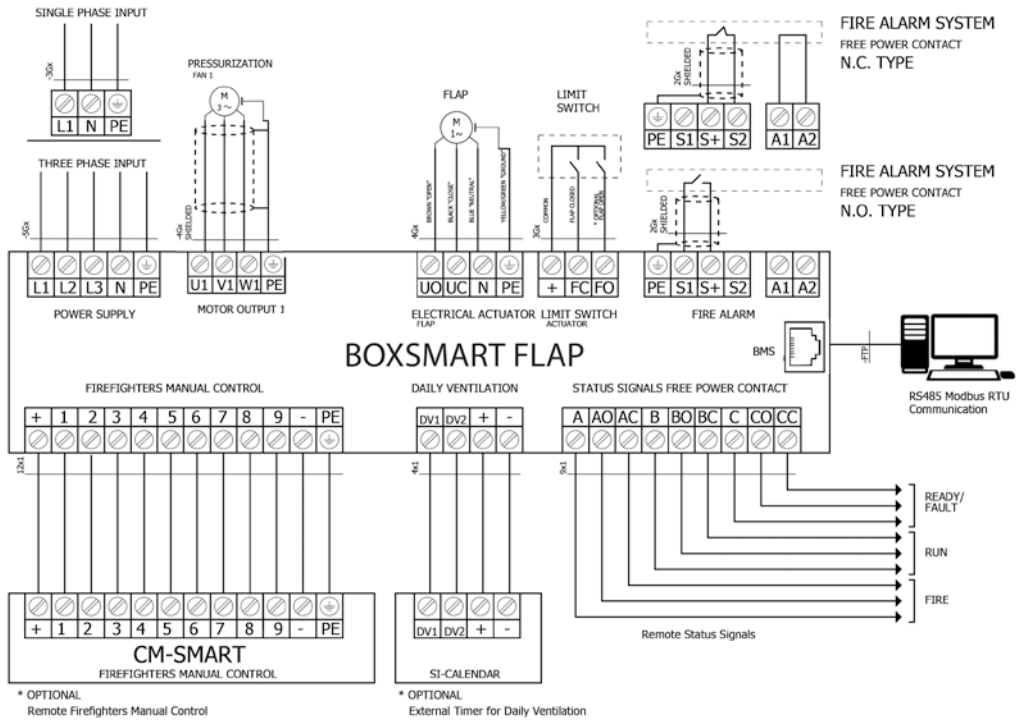

Accessories



CM-SMART



SI-CALENDAR

KIT SOBREPRESIÓN



Pressurisation system for stairs or evacuation routes. Maintains a differential pressure of 50 Pa in a single stage, designed according to the European standard EN 12101-6

STAIRCASES OVERPRESSURE KIT

For three-phase equipment



STAIRCASES OVERPRESSURE KIT

• Staircase overpressure kit, consisting of a control panel (BOXPRES KIT) and drive units (CJHCH or CJBD), for pressurizing stairways and evacuation routes. Also available for single phase equipment.

OVERPRESSURE KIT WITH STANDBY FAN

• Overpressure kit with standby fan comprised of a control panel (BOXPRES KIT II) with a built-in automatic switching system that maintains the overpressure in the event of a failure in the main fan and air impulsion units with a back-up fan.
• The BOXPRES control panel not only complies with the strictest requirements, it simplifies the work for the installer.

It includes:

- Variable frequency drive programmed at 50 Pa.
- Differential pressure probe.
- Magnetic thermal switch.
- Line and fault LEDs.
- Check button.

STAIRCASES OVERPRESSURE KIT

For single-phase equipment



BOXPRES is a control box with all its connections made and tested. Ready to operate and perform its function on the control of the installation pressure. Possibility of checking the installation to avoid failures. Only the power line, the supply fan and the fire signal should be connected.

The single-phase panels include:

- Voltage regulator programmed at 50 Pa.
- Differential pressure probe external to the equipment.

OVERPRESSURE KIT WITH STANDBY FAN



- Easy to install.
- A compact, autonomous solution.
- Preventive maintenance.
- Easy start-up.
- Safe, functional installation.



Order code

KIT SOBREPRESIÓN

—

7100

KIT SOBREPRESIÓN: Staircases overpressure unit
KIT SOBREPRESIÓN II: Overpressure unit with standby fan

Maximum flow rate
(m³/h)

Technical characteristics

Model	Power supply	Outlet	Impulsion unit	Flow rate (m ³ /h)	Noise level dB (A)
KIT SOBREPRESION-1400-LED	230 V AC II	230 V AC II	NEOLINEO-250	1400	66
KIT SOBREPRESION-2200-LED	230 V AC II	230 V AC II	NEOLINEO-315	2200	69
KIT SOBREPRESION-2700-LED	230 V AC II	230 V AC II	CJBD-2525-6M 1/3	2700	61
KIT SOBREPRESION-7100-LED	230 V AC II	230 V AC III	CJHCH-45-4T-0.5	7100	55
KIT SOBREPRESION-7800-LED	230 V AC II	230 V AC III	CJBD-3333-6T-1 1/2	7800	55
KIT SOBREPRESION-12900-LED	230 V AC II	230 V AC III	CJHCH-56-4T-1	12900	60
KIT SOBREPRESION-17000-LED	230 V AC II	230 V AC III	CJHCH-63-4T-1.5	17000	61
KIT SOBREPRESION-7100-BOX	400 V AC III	400 V AC III	CJHCH-45-4T-0.5	7100	55
KIT SOBREPRESION-7800-BOX	400 V AC III	400 V AC III	CJBD-3333-6T-1 1/2	7800	55
KIT SOBREPRESION-12900-BOX	400 V AC III	400 V AC III	CJHCH-56-4T-1	12900	60
KIT SOBREPRESION-17000-BOX	400 V AC III	400 V AC III	CJHCH-63-4T-1.5	17000	61
KIT SOBREPRESION II-7800-BOX	400 V AC III	400 V AC III	CJBD/TWO-3333-6T-1.5	7800	75
KIT SOBREPRESION II-11400-BOX	400V AC III	400 V AC III	CJBD/TWO-15/15-6T-3	11400	75
KIT SOBREPRESION II-12900-BOX	400 V AC III	400 V AC III	CJHCH/DUPLEX-56-4T-1-H	12900	60
KIT SOBREPRESION II-17000-BOX	400 V AC III	400 V AC III	CJHCH/DUPLEX-63-4T-1.5-H	17000	61
SI-PRESIÓN TPDA					
SI-PRESIÓN TPDA c/DISPLAY					
BOXPRES KIT-3A 230Vac	230 V AC II	230 V AC II			
BOXPRES KIT-10A 230Vac	230 V AC II	230 V AC II			
BOXPRES KIT-0.37W 230Vac	230 V AC II	230 V AC II			
BOXPRES KIT-0.75KW 230Vac	230 V AC II	230 V AC III			
BOXPRES KIT-1.5KW 230Vac	230 V AC II	230 V AC III			
BOXPRES KIT-2.2KW 230Vac	230 V AC II	230 V AC II			
BOXPRES KIT-0.75KW 400Vac	400 V AC III	400 V AC III			
BOXPRES KIT-1.5KW 400Vac	400 V AC III	400 V AC III			
BOXPRES KIT-2.2KW 400Vac	400 V AC III	400 V AC III			
BOXPRES KIT II - 1.5KW 400Vac	400 V AC III	400 V AC III			
BOXPRES KIT II - 2.2KW 400Vac	400 V AC III	400 V AC III			

Dimensions mm

CJBD

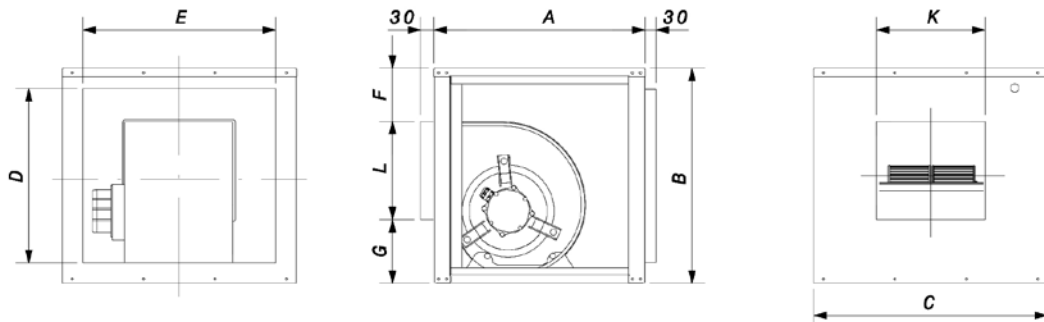

	Equivalence inches	A	B	C	D	E	F	G	K	L
CJBD-2525	9/9	500	522	550	426	454	107	147	303	268
CJBD-3333	12/12	650	650	700	554	604	105	198	392	347

Dimensions mm

CJHCH

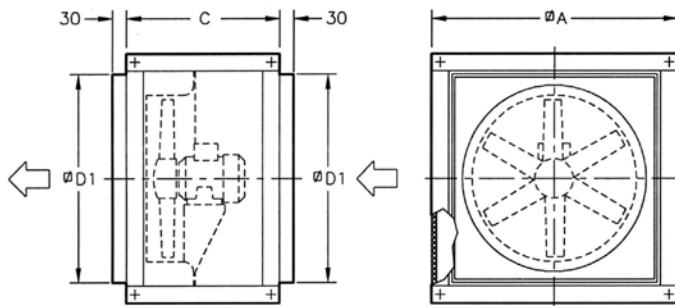

	A	C	D1
CJHCH-45	700	550	565
CJHCH-56/63	825	550	690

CJBD/TWO

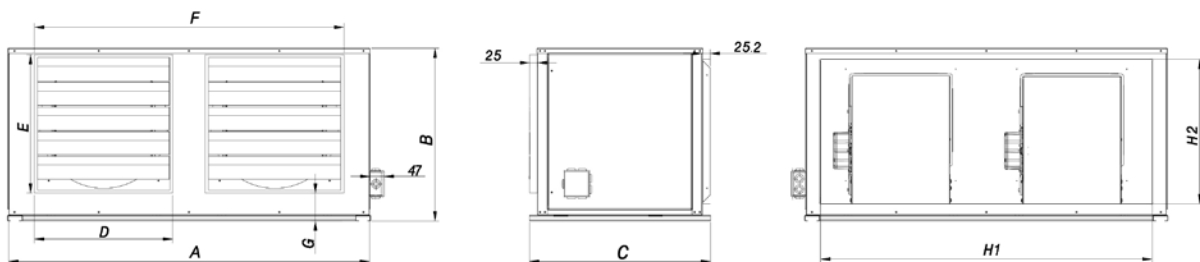

	A	B	C	D	E	F	G	H1	H2
CJBD/TWO-3333	1390	648.5	702.4	460	460	1149.3	156	1294.6	553.6
CJBD/TWO-15/15	1600	754	851.4	545	545	1342.6	186.5	1502.6	658.6

CJHCH/DUPLEX

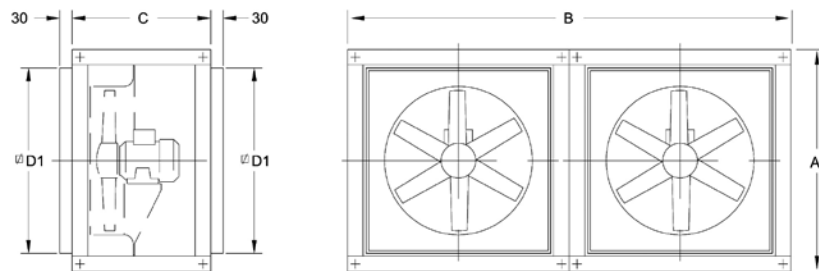

	A	B	C	D1
CJHCH/DUPLEX-56/63	825	1650	550	690

NEOLINEO

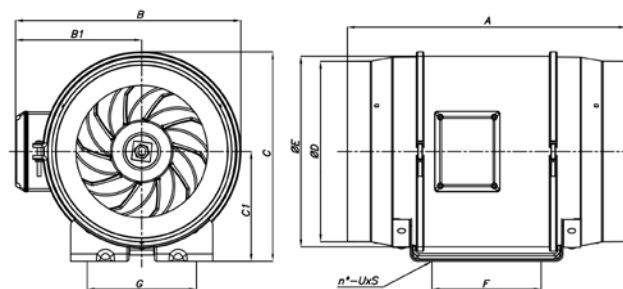

	A	B	B1	C	C1	ØD	ØE	F	G	n°	UxS
NEOLINEO-250/V	383	310	174	286	150	247	261	150	150	4	8x11
NEOLINEO-315/V	446	386	216	357	187	312	325	181	178	4	8x11

Technical characteristics and dimensions

BOXPRESS KIT SOBREPRESIÓN

Model	Power	Power supply	Outlet	Max. Output current	Size	Measurements (length x width x depth)
	(kW)	(V) (Hz)	(V)	(A)		
BOXPRES KIT-3A 230Vac	-	230 V AC II	230 V AC II	3.0	-	255 x 170 x 140 mm
BOXPRES KIT-10A 230Vac	-	230 V AC II	230 V AC II	10.0	-	255 x 170 x 140 mm
BOXPRES KIT-0.37W 230Vac	0.37	230 V II / 50 Hz	230 V III / 50 Hz	2.3	1	270 x 270 x 170 mm
BOXPRES KIT-0,75kW 230Vac	0.75	230 V II / 50 Hz	230 V III / 50 Hz	4.3	1	270 x 270 x 170 mm
BOXPRES KIT-1.5kW 230Vac	1.50	230 V II / 50 Hz	230 V III / 50 Hz	7.0	1	270 x 270 x 170 mm
BOXPRES KIT-2.2KW 230Vac	2.20	230 V II / 50 Hz	230 V III / 50 Hz	10.5	2	360 x 360 x 205 mm
BOXPRES KIT-0.75KW 400Vac	0.75	400 V III / 50 Hz	400 V III / 50 Hz	2.2	1	270 x 270 x 170 mm
BOXPRES KIT-1.5KW 400Vac	1.50	400 V III / 50 Hz	400 V III / 50 Hz	4.1	1	270 x 270 x 170 mm
BOXPRES KIT-2.2KW 400Vac	2.20	400 V III / 50 Hz	400 V III / 50 Hz	5.8	2	360 x 360 x 205 mm

Equipment cable entry gland

BOXPRES KIT-3A / KIT-10A



BOXPRES KIT Size 1 and 2



BOXPRESS KIT SOBREPRESIÓN II

For equipment with a reserve fan

Model	Power	Power supply	Outlet	Max. Output current	Size	Measurements (length x width x depth)
	(kW)	(V) (Hz)	(V)	(A)		
BOXPRES KIT II-1.5KW 400Vac	1.5	400 V III / 50 Hz	400 V III / 50 Hz	4.1	1	270 x 270 x 170 mm
BOXPRES KIT II-2.2KW 400Vac	2.2	400 V III / 50 Hz	400 V III / 50 Hz	5.4	2	360 x 360 x 205 mm

Both motors will never operate simultaneously.

Equipment cable entry gland

BOXPRES KIT Size 1 and 2

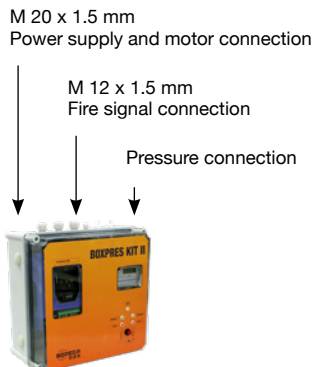

Application example

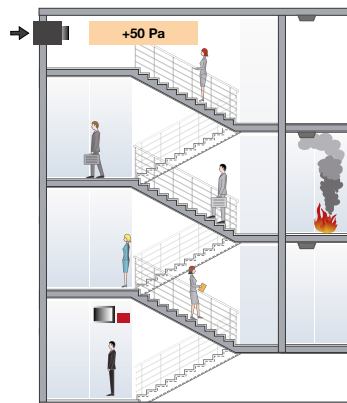

Overpressure smoke control method

This system uses pressurisation by injecting air into spaces that are used as evacuation routes in the event of a fire, including stairwells, corridors, passageways, lifts, etc., especially in tall buildings with high occupancy.

The method is based on using air speed and over pressure to create a barrier, preventing smoke from entering evacuation routes.

KIT BOXPRES PLUS



Pressurisation system for stairs or evacuation routes. Maintains a differential pressure of 50 Pa in a single stage, designed according to the European standard EN 12101-6



The correct operation of the pressurisation systems depends not only on their sound design, but also on the correct regulation performed by the system. For this reason, it is extremely important to have calibrated, high precision regulation elements that will permit both situations present in the event of a fire to be maintained simultaneously, quickly and stably.

KIT BOXPRES PLUS

- Staircase overpressure kit comprised of a control panel (BOXPRES PLUS) and an impulsion unit (CJHCH or CJBD), for pressurising staircases and evacuation routes.

KIT BOXPRES PLUS II

- Overpressure kit with standby fan comprised of a control panel (BOXPRES PLUS II) with a built-in automatic

switching system that maintains the overpressure in the event of the main fan failure.

CM-SMART External control panel for firefighters

- The CM-SMART indicates the system status and provides firefighters with the option of manually turning the system on or off via its selector switch. We recommend that this panel be installed at the main entry point to the protected area.
- This unit is not included in the KIT BOXPRES PLUS.
- The BOXPRES PLUS and BOXPRES PLUS II models are compatible with CM-SMART.



- Easy to install.
- A compact, autonomous solution.
- Easy start-up.
- Safe, functional installation.

Order code

KIT BOXPRES PLUS – 7100 – 230

KIT BOXPRES PLUS: Overpressure unit
KIT BOXPRES PLUS II: Overpressure unit with standby fan

Maximum flow rate (m³/h)

230: Single-phase 200 to 240 V 50/60 Hz input
400: Three-phase 380 to 480 V 50/60 Hz input

Technical characteristics

Model	Power (kW)	Power supply (V) (Hz)	Outlet (V)	Maximum flow rate (m ³ /h)	Impulsion unit
KIT BOXPRES PLUS-2880 - 230	0.37	200 a 240 V 50/60 Hz	230 V 50/60 Hz	2880	CJBD-2828-4M 1/2
KIT BOXPRES PLUS-7100 - 230	0.37	200 a 240 V 50/60 Hz	230 V 50/60 Hz	7100	CJHCH-45-4T-0.5 IE3
KIT BOXPRES PLUS-7800 - 230	1.10	200 a 240 V 50/60 Hz	230 V 50/60 Hz	7800	CJBD-3333-6T 1 1/2
KIT BOXPRES PLUS-12900 - 230	0.75	200 a 240 V 50/60 Hz	230 V 50/60 Hz	12900	CJHCH-56-4T-1 IE3
KIT BOXPRES PLUS-17000 - 230	1.10	200 a 240 V 50/60 Hz	230 V 50/60 Hz	17000	CJHCH-63-4T-1.5 IE3
KIT BOXPRES PLUS-7800 - 400	1.10	380 a 480 V 50/60 Hz	400 V 50/60 Hz	7800	CJBD-3333-6T 1 1/2
KIT BOXPRES PLUS-12900 - 400	0.75	380 a 480 V 50/60 Hz	400 V 50/60 Hz	12900	CJHCH-56-4T-1 IE3
KIT BOXPRES PLUS-17000 - 400	1.10	380 a 480 V 50/60 Hz	400 V 50/60 Hz	17000	CJHCH-63-4T-1.5 IE3
KIT BOXPRES PLUS-21100 - 400	1.50	380 a 480 V 50/60 Hz	400 V 50/60 Hz	22100	CJHCH-71-4T-2 IE3

The output power is reduced by 20% when the equipment is operating in the lower power supply voltage range. The same models may be supplied with the KIT BOXPRES PLUS II for standby fan (a second impulsion unit is added that is equivalent to that of the KIT BOXPRES PLUS).

Dimensions mm

CJHCH

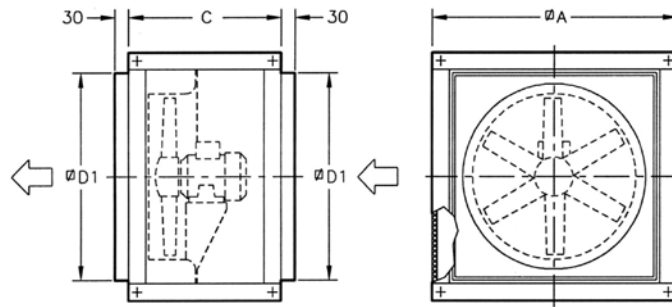

	ØA	C	ØD1
CJHCH-45	700	550	565
CJHCH-56/63	825	550	690
CJHCH-71	1000	650	850

CJBD

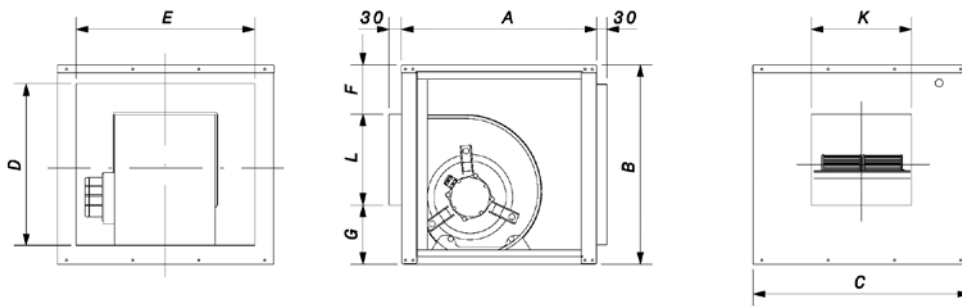

	Equivalence inches	A	B	C	D	E	F	G	K	L
CJBD-2828	10/10	550	575	600	479	504	104	177	330	294
CJBD-3333	12/12	650	650	700	554	604	105	198	392	347

BOXPRES PLUS

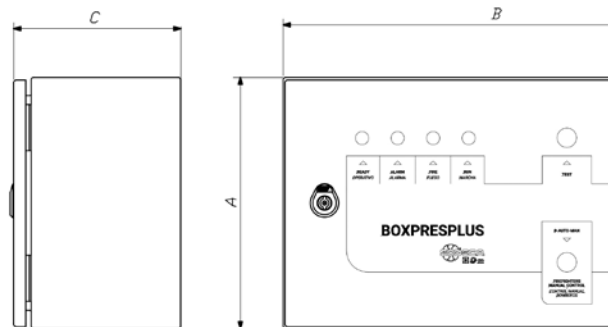

Size	A	B	C
1	300	400	200
2	400	500	250
3	400	600	250
4	500	700	250

PRESSKIT



Pressurisation equipment for lobbies, compliant with DM 30/11/1983 and designed according to the European standard EN 12101-6



Certified: NR331151

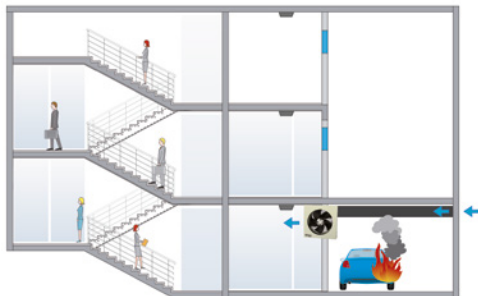

+50 Pa

The PRESSKIT equipment is comprised of one or more fans. In the event of a fire, they are activated to exert an overpressure of 50 Pa in safe areas and to prevent the entry of smoke in the evacuation routes for people.

Common features:

- Self-regulation of pressure throughout the lobby.
- EC brushless fans 24 V DC with a maximum flow of 2100 m³/H.
- Maintain an overpressure of 50 Pa in hallways.

CONTROL PANEL

- S models: simplified regulation of the ventilation unit by means of a pressure probe with incorporated PID signal regulator.
- P models: PLC control with multiple inputs, outputs, alarms and fan regulation through PID signal.
- Power panel with autonomy of more than 2 hours using 18Ah batteries.
- Easy connection of equipment.
- Quick configuration and adjustment of all parameters through LCD screen and keyboard.
- MANUAL system activation button.
- Real time visualization of the pressure of the safe zone and the status of the equipment.
- Control panel of the system by means of a PLC of reduced size and easy installation. 230 VAC power.

- Open door detection digital input.
- Digital outputs indicating activated fire alarm. By visual and acoustic indicator in intermittent mode with configurable times.
- Configurable connection delay times in the event of fire alarm detection and open fire doors.
- Visualization of pressure in Pa in real time. Status indication of the STANDBY/PRESSURIZING equipment.
- Possibility of controlling 2 fans with a single panel and power supply. (PRESSKIT TWIN).
- Key lock.

PRESSURIZATION FAN

- Wall fan for 310 mm diameter ducts.
- Lifespan in continuous work of more than 20,000 hours.
- Impeller made of painted sheet steel.
- Anti-contact protection grid.

PRESSURE SENSOR WITH DISPLAY (INCORPORATED IN CONTROL PANEL)

- Preset differential pressure sensor of 0-100 Pa.
- LCD screen.
- High precision calibrated analog sensor.



Control panel characteristics

- Total voltage (V): 1x230
- Output voltage 1 (V): 19.7-28 V DC
- Max. Output current 1 (A): 6
- Protection (IP): 44
- Approx. weight (Kg): 30.5
- Total current (A): 0.3
- Output voltage 2 (V): 19.7-28 V DC
- Max. Output current 2 (A): 7
- Operating temperature (°C): -25 a +60

Order code

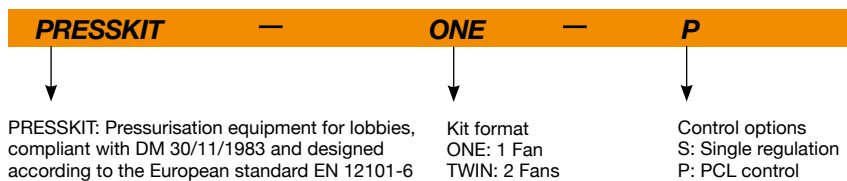

Technical characteristics

Model	Flow rate (m ³ /h)	Maximum pressure (Pa)	Speed (r/min)	LpA irradiated 3 m dB(A)	Total voltage (V)	Total current (A)	Total power (w)	Approx. weight (Kg)	Protection (IP)	Operating temperature (°C)	Nominal diameter of conduit (mm)
PRESSKIT ONE	2100	180	1800	65	24 V DC	4.8	115	7	42	-25 a +60	310
PRESSKIT TWIN	4100	180	1800	68	24 V DC	9.6	230	14	42	-25 a +60	310

Dimensions mm

PRESSURISATION FAN

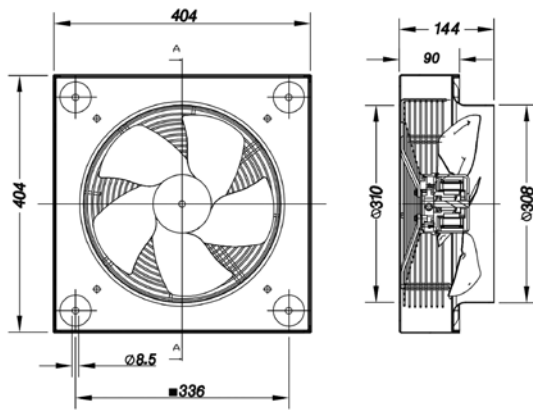

CONTROL PANEL

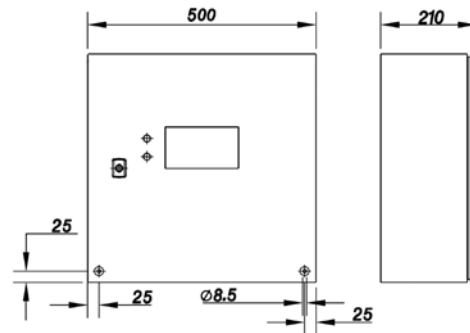

Kit characteristics

Component	PRESSKIT	
	ONE	TWIN
Regulation by means of pressure sensor	YES	YES
Regulation of several fans	-	YES*
Relay outputs to indicate the equipment is activated	YES	YES
Door sensor inputs	YES	YES

* PRESSKIT TWIN regulates two fans simultaneously with a single pressure sensor for large lobbies/pressurised areas. The regulation of each fan is not separate, they have the same PID set point depending on the signal received from the sensor.

Configurations

Component	PRESSKIT	
	ONE	TWIN
EC FAN BRUSHLESS 24 VDC	1 unit	2 units
CONTROL PANEL	1 unit	1 unit
PRESSURE SENSOR (BUILT INTO CONTROL PANEL)	1 unit	1 unit

Accessories



ALARM
PUSH
BUTTON



CHECKER
BATTERIES

Power source and battery output voltage checker via RJ45 connector.

BOXPRES PLUS

Control panel for a fan



The BOXPRES PLUS control panel includes:

- Variable frequency drive programmed at 50 Pa and highly accurate differential pressure probe.
- External connection for the control panel to be used exclusively by firefighters.
- Magnetic thermal switch.
- Status indicator lamp: Ready, Alarm, Fire and Run.
- Built-in control panel with TEST selector for maintenance and selector to be used exclusively by firefighters 0-AUTO-MANUAL.
- Operating procedures in safe mode in the case of failure of the differential pressure probe and automatic reset of the system in case of failure.
- Connection of status signals using free power contacts (FAULT, START and FIRE

ACTIVATION) and connection to BMS systems via RTU Modbus for monitoring the equipment.

- Remains operational once activated by the fire alarm, even when the activation signal is interrupted.
- Metal casing with lock with key and with IP66 protection.
- Capable of managing asynchronous motors, IPM or RM.
- Ready to operate and perform its function of pressure control.
- Only the power supply, the impulsion fan and the fire signal need to be connected.
- Different input voltage ranges and power on demand.

Order code

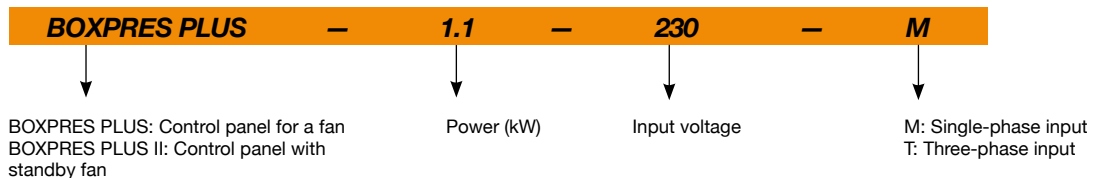

Technical characteristics and dimensions

BOXPRES PLUS							
Model	Power	Power supply	Outlet	Max. Output current	Size	Measurements	Approx. weight
	(kW)	(V) (Hz)	(V)	(A)		(length x width x depth)	(Kg)
BOXPRES PLUS-0.37-230V 50/60Hz-M-T	0.37	200 a 240 V 50/60 Hz	230 V 50/60 Hz	2.3	1	300x400x200	11
BOXPRES PLUS-0.75-230V 50/60Hz-M-T	0.75	200 a 240 V 50/60 Hz	230 V 50/60 Hz	4.3	1	300x400x200	11
BOXPRES PLUS-1.5-230V 50/60Hz-M-T	1.50	200 a 240 V 50/60 Hz	230 V 50/60 Hz	7.0	1	300x400x200	11
BOXPRES PLUS-0.75-400V 50/60Hz-T-T	0.75	380 a 480 V 50/60 Hz	400 V 50/60 Hz	2.2	1	300x400x200	11
BOXPRES PLUS-1.5-400V 50/60Hz-T-T	1.50	380 a 480 V 50/60 Hz	400 V 50/60 Hz	4.1	1	300x400x200	11
BOXPRES PLUS-2.2-400V 50/60Hz-T-T	2.20	380 a 480 V 50/60 Hz	400 V 50/60 Hz	5.8	2	400x500x250	18
BOXPRES PLUS-4-400V 50/60Hz-T-T	4.00	380 a 480 V 50/60 Hz	400 V 50/60 Hz	9.5	2	400x500x250	18
BOXPRES PLUS-5.5-400V 50/60Hz-T-T	5.50	380 a 480 V 50/60 Hz	400 V 50/60 Hz	14.0	3	400x600x250	21
BOXPRES PLUS-7.5-400V 50/60Hz-T-T	7.50	380 a 480 V 50/60 Hz	400 V 50/60 Hz	18.0	3	400x600x250	21
BOXPRES PLUS-11-400V 50/60Hz-T-T	11.00	380 a 480 V 50/60 Hz	400 V 50/60 Hz	24.0	3	400x600x250	21

Technical characteristics and dimensions

BOXPRES PLUS II

For systems with a standby fan. The fans never operate simultaneously.

Model	Power	Power supply	Outlet	Max. Output current	Size	Measurements (length x width x depth)	Approx. weight (Kg)
	(kW)	(V) (Hz)	(V)	(A)			
BOXPRES PLUS II-0.37-230V 50/60Hz-M-T	0.37	200 a 240 V 50/60 Hz	230 V 50/60 Hz	2.3	2	400x500x250	18
BOXPRES PLUS II-0.75-230V 50/60Hz-M-T	0.75	200 a 240 V 50/60 Hz	230 V 50/60 Hz	4.3	2	400x500x250	18
BOXPRES PLUS II-1.5-230V 50/60Hz-M-T	1.50	200 a 240 V 50/60 Hz	230 V 50/60 Hz	7.0	2	400x500x250	18
BOXPRES PLUS II-0.75-400V 50/60Hz-T-T	0.75	380 a 480 V 50/60 Hz	400 V 50/60 Hz	2.2	2	400x500x250	18
BOXPRES PLUS II-1.5-400V 50/60Hz-T-T	1.50	380 a 480 V 50/60 Hz	400 V 50/60 Hz	4.1	2	400x500x250	18
BOXPRES PLUS II-2.2-400V 50/60Hz-T-T	2.20	380 a 480 V 50/60 Hz	400 V 50/60 Hz	5.8	3	400x600x250	20
BOXPRES PLUS II-4-400V 50/60Hz-T-T	4.00	380 a 480 V 50/60 Hz	400 V 50/60 Hz	9.5	3	400x600x250	20
BOXPRES PLUS II-5.5-400V 50/60Hz-T-T	5.50	380 a 480 V 50/60 Hz	400 V 50/60 Hz	14.0	4	500x700x250	28
BOXPRES PLUS II-7.5-400V 50/60Hz-T-T	7.50	380 a 480 V 50/60 Hz	400 V 50/60 Hz	18.0	4	500x700x250	28
BOXPRES PLUS II-11-400V 50/60Hz-T-T	11.00	380 a 480 V 50/60 Hz	400 V 50/60 Hz	24.0	4	500x700x250	28

Connections

*All connections are made at the top section of the panel.

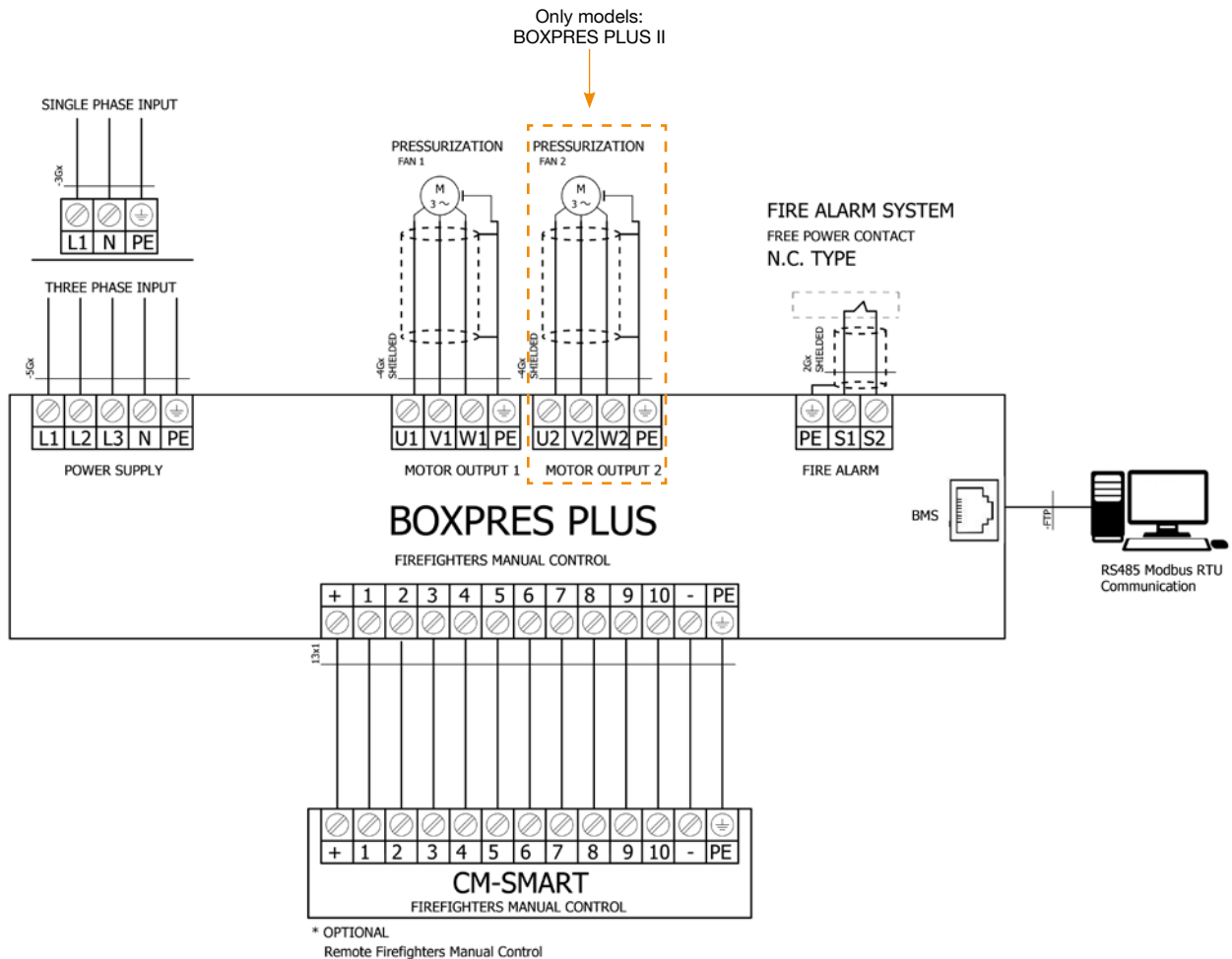

Dimensions mm

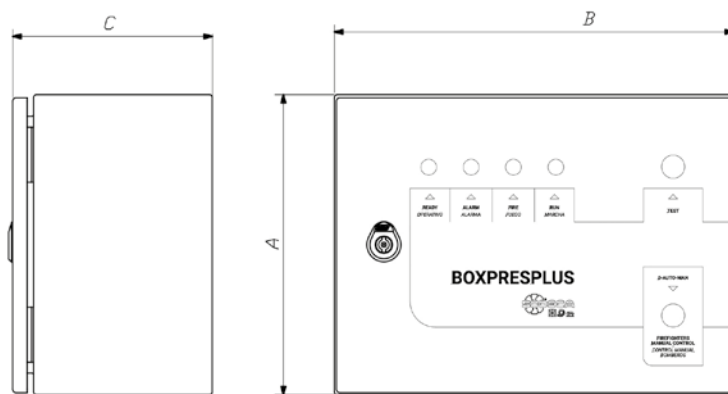

Size	A	B	C
1	300	400	200
2	400	500	250
3	400	600	250
4	500	700	250

Application example

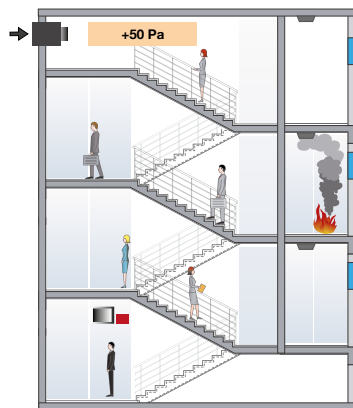

Overpressure smoke control method

This system uses pressurisation by injecting air into spaces that are used as evacuation routes in the event of a fire, including stairwells, corridors, passageways, lifts, etc., especially in tall buildings with high occupancy.

The method is based on using air speed and over pressure to create a barrier, preventing smoke from entering evacuation routes.

Accessories



CM-SMART

BOXPARK

Control panels for car park ventilation systems with triple purpose: daily ventilation, CO concentration control and smoke extraction in case of fire



Control panels in metal enclosure with all the necessary elements for the management and control of fans in car park ventilation systems, whether they are based on duct networks or impulse fans, for the control of CO concentration levels and smoke extraction in case of fire. Customised panels for all power ratings and number of fans according to project requirements.

BOXPARK BASIC:

- Control panel for smoke extraction in case of fire and CO control in single zone car parks, with daily ventilation mode using a time programmer included.

BOXPARK ADVANCED:

- Control panel for smoke extraction in case of fire and CO control in car parks for single or multiple zones, with daily ventilation mode using a time programmer included, with the possibility of managing motorised dampers and incorporating a remote panel for fire fighters.

BOXPARK ADVANCED PLC:

- Control panel for smoke extraction in case of fire and CO control in car parks for single or multiple zones, with daily ventilation mode using a time programmer included, with the possibility of managing motorised dampers and incorporating a remote panel for fire fighters. Includes PLC with algorithm for managing the activation sequence of the ventilation systems, either by duct networks or by impulse (Jet fan type), in case of fire, with MODBUS communications and WEB SERVER incorporated. All the logic of the system can be adapted to the project on demand.

Generic specifications BXPARK cabinet on request:

- Power supply: 400 V AC three-phase plus neutral and earth conductor.
- Metal enclosure, depending on the dimensions of the wall-mounted or self-supporting equipment with plinth.
- Load-break disconnect switch sized to the maximum power of the system.
- Natural or forced ventilation of the electrical panel, with thermostat for activation/deactivation and thermomagnetic circuit breaker protection.
- Interior cabinet lighting (from 1600 mm height).
- Auxiliary voltage for 24 V DC control through power supply and protections.
- SCHUKO base inside the control panel (protected).
- Unbalance and phase loss detector.
- Overload and short-circuit protection per group.
- Depending on the drives, the equipment incorporates the following protections:
- Frequency converter starter (VSD): Individual input thermomagnetic circuit breaker.
- Single-speed contactor starter (S1): Individual thermomagnetic circuit breaker per group, individual motor-protective switch.
- Starting by double speed contactor (S2): Individual magnetothermic circuit breaker per group, individual motor protection switch for high speed, individual motor protection switch for slow speed.
- Back-up of the system's electronics by UPS in case of power failure.
- Microcontroller with programmable logic (PLC).
- Communication with BMS, MODBUS TCP protocol.
- WEB SERVER integrated for programming.
- Daily time switch with battery reserve, for activation of daily ventilation per zone.
- Connection input to monoxide control unit with three CO activation levels, low level, high level and alarm level. NO potential-free activation contacts.
- Connection input with fire detection control panel, via NO or NC potential-free activation contact (selectable). Memory of the last operating status and resettable fire activation signal, via key switch on the front of the control panel.
- 0-AUTO-MANUAL selectors per group.
- Control panel status lights per zone (System OK, Fault, Run, CO Activation and Fire Activation).
- Status signals (System OK, Fault, Run, CO Activation and Fire Activation).
- General magneto-thermal and differential line protection.
- Differential protection by group and zone (Jet fans, extraction, supply).
- 2-speed fan control.
- Fan control using a variable speed drive.
- Reversible fans control.
- LC filters (recommended with variable frequency drive (VSD) control from 50 m of EMC cable and from 100 m of non-screened cable).
- Possibility of request for several areas.
- Possibility of analogue CO signal for proportional operation.
- Remote control for firefighters that incorporates 0-AUTO-MANUAL selector, and status lights (System OK, Fault, Run and Fire Activation).
- Touch screen for monitoring and configuration.
- Motorised gate management.
- Interconnection between panels.

Comparison between models

Characteristics	BOXPARK BASIC	BOXPARK ADVANCED	BOXPARK ADVANCED PLC
Fire activation sequence (Jet fan delay)	NO	NO	YES
Communication with BMS, MODBUS TCP protocol	NO	NO	YES
Microcontroller with programmable logic (PLC)	NO	NO	YES
WEB SERVER integrated for programming	NO	NO	YES
Time clock for daily ventilation by zone	NO	YES	YES
Time clock for general daily ventilation	YES	NO	NO
Fire signal status memory card, including fire Reset selector	NO	YES	YES
2 levels of CO	NO	NO	YES
3 levels of CO	YES	YES	NO
Analogue CO signal for proportional operation	NO	NO	OPTIONAL
0-AUTO-MANUAL selectors per group	NO	YES	YES
Fire signal selectable NO-NC	YES	YES	YES
Status signals (System OK, Fault, Run, CO Activation and Fire Activation)	NO	YES	YES
Remote control panel for fire fighters CM (BOXSMART type)	NO	OPTIONAL	OPTIONAL
Multizone	NO	YES	YES
Status lights (System OK, Fault, Run, CO Activation and Fire Activation)	YES	YES	YES
Status lights per zone (System OK, Fault, Run, CO Activation and Fire Activation)	NO	NO	YES
Load-break disconnect switch	YES	YES	YES
Overload and short-circuit protection per group	YES	YES	YES
General magneto-thermal and differential line protection	NO	OPTIONAL	OPTIONAL
Differential protection by group and zone (Jet fans, extraction, supply)	NO	OPTIONAL	OPTIONAL
2-speed fan control	OPTIONAL	OPTIONAL	OPTIONAL
Fan control using a variable speed drive	OPTIONAL	OPTIONAL	OPTIONAL
Unbalance and phase loss detector	NO	OPTIONAL	YES
UPS	NO	NO	YES
Interior cabinet lighting (from 1600 mm height)	NO	NO	YES
SCHUKO base inside the control panel (protected)	NO	NO	YES
Interconnection between panels	NO	OPTIONAL	OPTIONAL
Enclosure ventilation (depending on control panel size and power)	YES	YES	YES
LC-filters (recommended from 50 m EMC cable, from 100 m non-screened cable)	OPTIONAL	OPTIONAL	OPTIONAL
Reversibility	NO	NO	OPTIONAL
Touch screen for monitoring and configuration	NO	NO	OPTIONAL
Motorised gate management	NO	OPTIONAL	OPTIONAL

Installation examples with BOXPARK

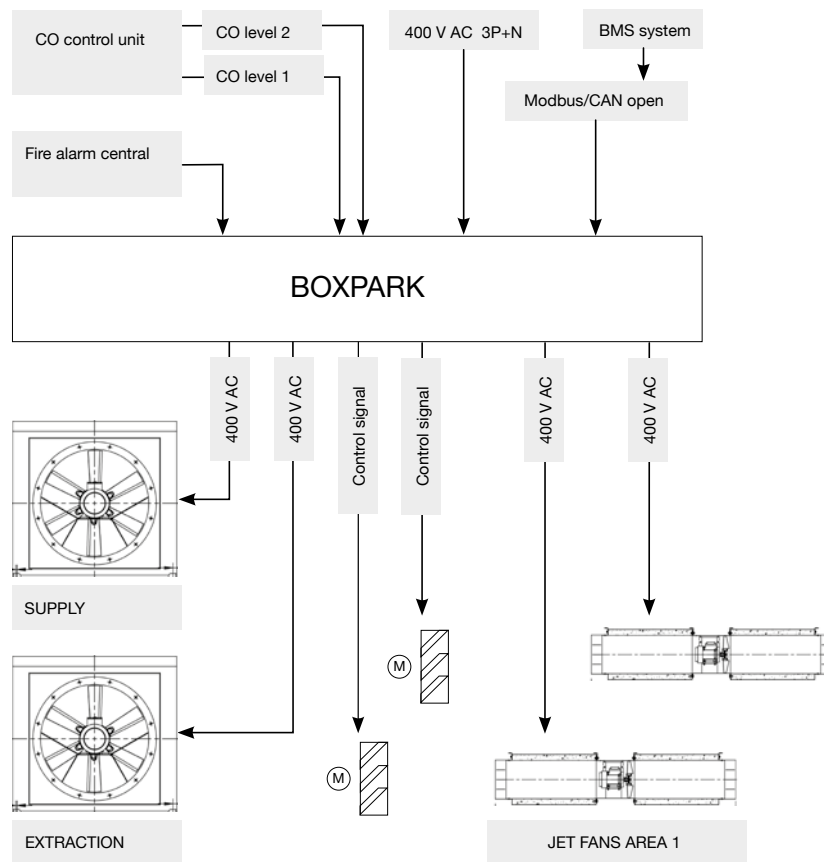

Accessories



CM-SMART



CENTRAL CO

ACCESSORIES



INT

On/Off safety switches in accordance with Standard UNE-EN 60204-1

Characteristics:

- Switches to be installed next to the fan to be able to cut off the power before handling the fan.
- IP65 protection.
- Single-phase or three-phase fans, use a 3-pole switch (3CA).
- Three-phase two-speed fans, use a 6 pole switch (6CA).

Model	Current (A)	(kW)	Cable entry (mm)
INT-KG 20/3CA	25	7.5	29
INT-KG 41/3CA	40	15	37.5
INT-KG 64/3CA	63	22	37.5
INT-KG 80/3CA	80	30	37.5
INT-KG 100/3CA	100	37	37.5
INT-KG 20/6CA	25	7.5	29
INT-KG 41/6CA	40	15	37.5
INT-KG 64/6CA	63	22	37.5
INT-KG 80/6CA	80	30	37.5
INT-KG 100/6CA	100	37	37.5



INT/ATEX

ATEX stop-start switch according to directives 2014/34/UE and 2014/35/UE II 2D Ex tb IIIC T XX °C Db II 3G Ex nR IIC T6 Gc IP66

Characteristics:

- II 3G Ex nR IIC T6 Gc
- II 2D Ex tb IIIC T XX °C Db IP66
- IP66 protection.
- Manufactured from anti-static thermoplastic.
- 3 pole switches for three-phase motors at a maximum line voltage of 500 V.

Model	Maximum current (A)		Voltage (V)	Max. Motor power (kW) 400V	Cable entry (mm)
	for zone 21 and 22 (Dust)	for zone 2 (Gas)			
INT/ATEX 16/3CA	16	10	500	5.5	10÷14
INT/ATEX 25/3CA	25	20	500	7.5	12÷18
INT/ATEX 40/3CA	40	32	500	15.0	12÷18
INT/ATEX 63/3CA	63	50	500	22.0	16÷25



IAT

Stop-start safety switches for 400 °C/2h to comply with the UNE-EN 60204-1 Standard

Characteristics:

- Switches to be installed next to the fan and thus be able to cut off the power before handling the fan.
- IP65 protection model 400 °C / 2h.

Model	Current (A)	Model	Current (A)
IAT-400-20/3P	20	IAT-400-20/6P	20
IAT-400-32/3P	32	IAT-400-32/6P	32
IAT-400-63/3P	63	IAT-400-63/6P	63
IAT-400-125/3P	125	IAT-400-125/6P	125



C2V

Switch for two speed motors

Characteristics:

- 3 position 1-0-2 switch for driving 2 speed motors with Dahlander connection.
- IP67 protection.

Model	Current (A)	(kW)	Cable entry (mm)
C2V-CG10 A441	20	5.5	20

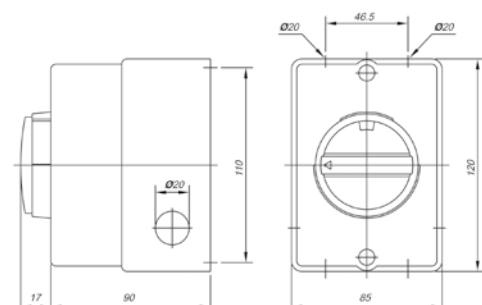

ACCESSORIES



CABLE BOX

Electrical cable and connection box kit 400 °C/2h for external connections to the motor in fire fighting installations

Characteristics:

- 6 stranded electric cable + ground wire connection with a length of 1.5 m and terminals at each end.
- Terminal box in cast aluminum.
- Terminal block in ceramic material.
- Kit certified together with the CJBTD series of extractors, with certification No. 0370-CPR-0580.

Model	Max. motor size	Maximum power 400V (HP)		Applicable to diameters												
		1 speed	2 speeds	40	45	50	56	63	71	80	90	100	125	140	160	
CABLE BOX-1-400 (4Gx2.5)-450	100	4	N/A	X	X	X	X	X	X							
CABLE BOX-1-400 (7Gx2.5)-450	112	5.5	6	X	X	X	X	X	X							
CABLE BOX-2-400 (7Gx2.5)-550	160	12	12				X	X		X	X					
CABLE BOX-2-400 (7Gx2.5)-800	132	10	9										X			
CABLE BOX-3-400 (7Gx4)-800	160	20	20										X			
CABLE BOX-3-400 (7Gx6)-800	160	22	22					X						X	X	X
CABLE BOX-4-400 (7Gx10)-800	280	75	40											X	X	X
CABLE BOX-4-400 (13Gx10)-800	280	100	N/A											X		

RM



Electronic speed controllers for single-phase motors

The RM models are voltage regulated. The RM/VSD1 models are frequency regulated.

Common features:

- Converters for speed variation for fans with asynchronous single-phase motors.
- Speed drive power supply single-phase 230 V 50/60 Hz.
- Start/Stop switch.
- Speed adjustment by analog command.
- According to the Electromagnetic Compatibility Directives 2014/30 / EU and Low Voltage 2014/35 / EU.

RM models features:

- Minimum speed adjustment.
- With EMC filters in accordance with Standard EN-55014.

RM/VSD1 model features:

- 16AF protective fuse.
- Dual passive (radiator) and active (cooling fan) heat dissipation system.

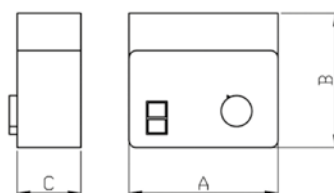

Model	A	B	C
RM-00	81	81	66
RM-01	81	81	66
RM-02	81	81	66
RM-1	80	145	80
RM-2	96	164	85
RM-3	96	164	85
RM/VSD1-3.5	200	180	100
RM/VSD1-8.0	200	225	100

Model	Regulation type	Input voltage	Output voltage	Protection	Maximum current (A)
RM-00	Voltage	230 V-50/60 Hz	230 V-50/60 Hz	IP44	0.5
RM-01	Voltage	230 V-50/60 Hz	230 V-50/60 Hz	IP44	1.0
RM-02	Voltage	230 V-50/60 Hz	230 V-50/60 Hz	IP44	2.0
RM-1	Voltage	230 V-50/60 Hz	230 V-50/60 Hz	IP54	3.0
RM-2	Voltage	230 V-50/60 Hz	230 V-50/60 Hz	IP54	5.0
RM-3	Voltage	230 V-50/60 Hz	230 V-50/60 Hz	IP54	10.0
RM/VSD1-3.5	Frequency	230 V-50/60 Hz	230 V-35...50 Hz	IP20	3.5
RM/VSD1-8.0	Frequency	230 V-50/60 Hz	230 V-35...50 Hz	IP20	8.0

ACCESSORIES



VSD3/A-RFT - VSD1/A-RFM

Electronic variable speed drive for AC motors

Characteristics:

- Converters for speed and frequency variation of axial and centrifugal fans with asynchronous three-phase motors.
- Converter power supply:
 - Single-phase (VSD1/A-RFM): 200-240 V 50/60 Hz.
 - Three-phase (VSD3/A-RFT): 380-480 V 50/60 Hz.
- In accordance with the Electromagnetic Compatibility Directive 2014/30/EU, the Low Voltage Directive 2014/35/EU and the Machinery Safety Directive 2006/42/EC.
- Stop/start input to disable/enable the drive.
- 0-10 V input for speed control.
- ModBus RTU bus connection available.
- Standard model with degree of protection IP20. Also available in IP66 version up to 10 CV. For powers greater than 15 CV, only available with protection degree IP55.
- According to norms:
 - UNE EN 61800-3: variable speed electric power drives. EMC related product standard including specific test methods.
 - UNE EN 61800-5-1: variable speed electric power drives. Security requirements. Electrical, thermal and energy.
 - UNE EN 60204-1: safety of machines. Electrical equipment of machines. General requirements.

- UNE EN 55011: limits and methods for measuring the characteristics related to radio electric disturbances of industrial, scientific and medical devices (ICM) that produce radio frequency energy.
- IEC 60529: specifications for degrees of protection in enclose premises.

In general, all SODECA fans with three-phase motors are adequate for operating supplied with a static frequency converter in normal execution (based on IEC 60034-17). However some motors require special measures. The maximum operating frequency or speed must never exceed that of the fan design. In applications with a quadratic torque such as fans and pumps, when the speed changes, the absorbed power is directly proportional to the rotation speed cube: $Pa2 = Pa1 (n2 / n1)^3$.

The insulation of the motors coupled to the fans is sufficient to work without restrictions with the frequency converter up to voltages of 500 V. The use of sinusoidal filters at the converter output will contribute to the correct operation of the motor, reducing failures and increasing its useful life. It is advisable that for motors greater than 225 size, these are requested with special windings for operating with a frequency converter.

The length of the output cable from the converter to the fan has an important effect on the voltage characteristics in the motor terminals. The definition 'long cables' will depend on the nominal value and type of converter, and the technical document of the manufacturer must be consulted.

Ex-d explosion-proof motors must be requested for activation with a frequency converter. The motor manufacturer should request information on the application using a questionnaire, to define the working parameters. Furthermore, these motors must have built-in TPC sensors.

Ex-e increased safety motors cannot be activated with a frequency converter (this would require the joint motor-converter certification).

VSD1/A-RFM		VSD1/A-RFM-0,5	VSD1/A-RFM-1	VSD1/A-RFM-2	VSD1/A-RFM-3
Power	(HP)	0.50	1.00	2.00	3.00
Power	(kW)	0.37	0.75	1.50	2.20
Maximum current	(A)	2.3	4.3	7.0	10.5
Inlet					
Inlet type		Single-phase	Single-phase	Single-phase	Single-phase
Voltage	(V)	200-240 V	200-240 V	200-240 V	200-240 V
Frequency	(Hz)	50-60 Hz	50-60 Hz	50-60 Hz	50-60 Hz
Outlet					
Outlet type		Three-phase	Three-phase	Three-phase	Three-phase
Voltage	(V)	200-240 V	200-240 V	200-240 V	200-240 V
Frequency	(Hz)	0-500 Hz	0-500 Hz	0-500 Hz	0-500 Hz
Degrees of protection		Standard: IP20. On request: IP66			
Cooling		IP20: Forced. IP66: Natural			

VSD3/A-RFT		VSD3/A-RFT-1	VSD3/A-RFT-2	VSD3/A-RFT-3	VSD3/A-RFT-5.5	VSD3/A-RFT-7.5	VSD3/A-RFT-10	VSD3/A-RFT-15	VSD3/A-RFT-20	VSD3/A-RFT-25	VSD3/A-RFT-30
Power	(HP)	1.00	2.00	3.00	5.50	7.50	10.00	15.00	20.00	25.00	30.00
Power	(kW)	0.75	1.50	2.20	4.00	5.50	7.50	11.00	15.00	18.50	22.00
Maximum current	(A)	2.2	4.1	5.8	9.5	14.0	18.0	24.0	30.0	39.0	46.0
Inlet											
Inlet type		Three-phase	Three-phase	Three-phase	Three-phase	Three-phase	Three-phase	Three-phase	Three-phase	Three-phase	Three-phase
Voltage	(V)	380-480 V	380-480 V	380-480 V	380-480 V	380-480 V	380-480 V	380-480 V	380-480 V	380-480 V	380-480 V
Frequency	(Hz)	50-60 Hz	50-60 Hz	50-60 Hz	50-60 Hz	50-60 Hz	50-60 Hz	50-60 Hz	50-60 Hz	50-60 Hz	50-60 Hz
Outlet											
Outlet type		Three-phase	Three-phase	Three-phase	Three-phase	Three-phase	Three-phase	Three-phase	Three-phase	Three-phase	Three-phase
Voltage	(V)	380-480 V	380-480 V	380-480 V	380-480 V	380-480 V	380-480 V	380-480 V	380-480 V	380-480 V	380-480 V
Frequency	(Hz)	0-500 Hz	0-500 Hz	0-500 Hz	0-500 Hz	0-500 Hz	0-500 Hz	0-500 Hz	0-500 Hz	0-500 Hz	0-500 Hz
Degrees of protection		Standard: IP20. On request: IP66						IP20	IP20	IP20	IP20
Cooling		IP20 e IP55: Forced. IP66: Natural									

ACCESSORIES



CENTRAL CO

Monoxide detection control box, for ventilation in parking lots

To comply with Royal Decree 2367/1985 and the Technical Building Code, carbon monoxide detection plants have been designed for application in underground car parks, tunnels or other places where dangerous concentrations of CO can accumulate.

The system consists of the installation of a control panel with 1 to 3 zone modules with an indicator display and each module allows the connection of up to 32 detectors connected with 2 wires, with a maximum distance to the last detector of 2 km. The detectors can be distributed over 2,000 m in length and each detector covers a maximum surface area of 200 m², as defined by current regulations.

Through the optional card FM-TC500 it is possible to control an RFM or RFT series speed regulator, in order to reduce energy consumption and the noise level of the extractors. These systems involve a significant energy saving.

- Certified system according to UNE 23300/84 standard.
- Certification LOM 09MOGA3054.
- Modular and extensible central control.
- Up to 19,000 m² of management.
- Versions of 1, 2, and 3 zone modules.
- Indication of the concentration per area.
- 2 extraction relay outputs by zone.
- 1 alarm relay output per zone.
- Up to 32 detectors per zone.
- 2 wires connection detectors.
- Mode of operation for low consumption.
- Variable speed control option to reduce energy consumption and noise level.
- Option of remote control of the system and integration with energy analysis systems.

Control units FMC-C-501/502/503 Series:

- For 1, 2 or 3 zones depending on the model.
- Supply Voltage: 90-264 V AC.
- Power: 45 W.
- FM-M-509 zone extension module.
- Wiring of the area: 2 wires.
- Maximum distance from the zone line: 2 km with 1.5 mm² cable.
- Number of detectors per zone: 32 detectors.

CO Detector series FM-DP500/FM-D500:

- Wall or ceiling mounted CO Detector according to model.
- Technology: electrochemical cell.
- Lifespan: 5 years.
- Resolution: 1 ppm.
- Reaction time: 10 seconds.
- Storage temperature: -10 °C to +80 °C.
- Working area: 200 m² limited by regulation.
- IP Index from FM-D500: IP20.
- IP Index from FM-DP500: IP54.

Control card by inverter FM-TC500 series:

- Module with PWM outputs that allows the extraction motors to be controlled by speed regulators (energy saving).
- Communications module to carry out remote maintenance and remote management actions.
- Open communications protocol for integration with other systems.

Model	Application
FMC-C-501	Centre for 1 area
FMC-C-502	Centre for 2 areas
FMC-C-503	Centre for 3 areas
FM-M-509	Module for extension of area
FM-DP500	CO wall detector
FM-D500	CO ceiling detector
FM-TC500	Control card per varier



AET

Star/delta starter and three-phase fan protection control panel, with stop and start buttons

Characteristics:

- Stop and start by button.
- Status display through pilot lights.
- With adjustable thermal relay for motor protection.
- Fully wired.
- Metal box for surface mounting, IP65 protection.
- The regulation current of the thermal relay must be 50% of the rated current shown on motor plate.

For fan with three-phase motor 400V/690V
Power supply 3x400V+N

Model	Thermal relay adjustment current (A)	Motor power 3x400/690V (kW)
AET-01-5.5/400	4-6.3	4.0
AET-01-7.5/400	5-8	5.5
AET-01-10/400	7-10	7.5
AET-01-15/400	12-18	11.0
AET-01-20/400	12-18	15.0
AET-01-30/400	18-26	18.5/22.0
AET-01-40/400	28-40	30.0
AET-02-50/400	34-50	37.0
AET-02-60/400	45-65	45.0
AET-02-75/400	45-65	55.0

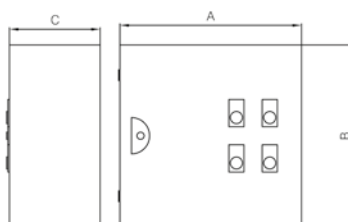

Model	A	B	C
AET-01	300	300	150
AET-02	400	400	200

ACCESSORIES



P-400

Backdraught louvres, certified for 400 °C/2h

Characteristics:

- They are supplied assembled in the box with its corresponding adapter.
- Approved in accordance with standard EN 12101-3, with certificate no.: 0370-CPR-0312.
- Steel sheet frame construction and aluminum sheet slats.
- It can be used for other applications 400 °C/2h.

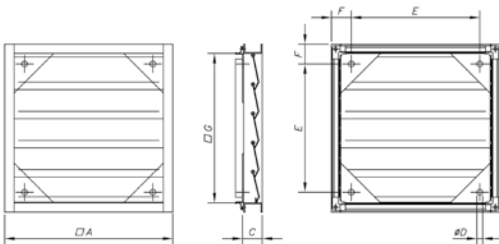

Model	G	A	C	ØD	E	F
P-400-56	565	615	51	6	455	80
P-400-63	690	760	72	6	600	80
P-400-80	850	920	72	6	740	90
P-400-100	1050	1120	72	6	940	90
P-400-125	1400	1486	102	6	1306	90
P-400-140	1500	1586	102	6	1366	110

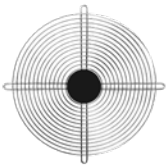
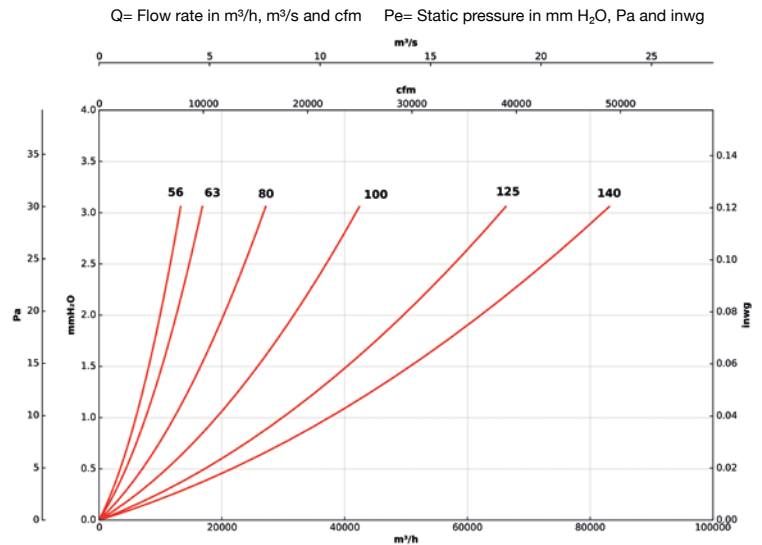

RT

Protection guard for inlet or outlet of long cased axial fans

Characteristics:

- Protects against contact with the impeller and prevents objects from entering in accordance with standard UNE-EN ISO 12499.
- Manufactured with electrowelded wire.
- In the HEPT series, can only be fitted on the outlet.

Model	øA	øB	C	P	N	Nxα	Form	Applicable to THT
RT-25	280	259	10	11	-	4x90°	1	-
RT-31/B	320	301	10	11	-	4x90°	1	-
RT-31	355	322	10	11	-	4x90°	1	-
RT-35	395	364	10	11	-	4x90°	1	-
RT-40	450	426	12	11	-	4x90°	1	40
RT-45	500	468	12	11	-	4x90°	1	45
RT-50	560	528	12	11	-	4x90°	1	50
RT-56	620	572	-	11	12	4x90°	2	56
RT-63	690	655	-	11	12	4x90°	2	63
RT-71	770	732	-	11	12	4x90°	2	71
RT-80	860	820	-	11	12	4x90°	2	80
RT-90	970	930	-	11	12	4x90°	2	90
RT-100	1070	1018	-	11	12	4x90°	2	100
RT-125	1320	1260	-	11	18	10x36°	2	125
RT-125/CC	1320	1260	-	11	18	10x36°	2	125

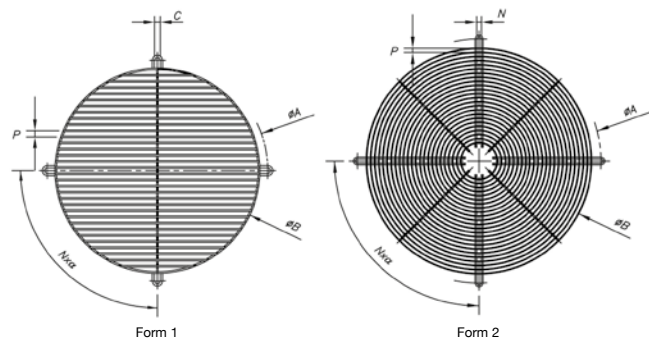

ACCESSORIES

RPA



Protection guard for inlet of centrifugal fans

Characteristics:

- Prevents against contact with the impeller and possible entry of objects, according to the UNE-EN ISO 12499 standard.
- Made of sheet steel.

Model	Applicable to	
	TCMP	TCR TCR/R
RPA-10	-	-
RPA-11	-	-
RPA-13	-	-
RPA-15	-	-
RPA-17	-	-
RPA-18	-	-
RPA-20	-	-
RPA-23	-	-
RPA-25	820	-
RPA-25/2	-	-
RPA-28	922	-
RPA-31	1025	-
RPA-32	-	-
RPA-35	1435/1640	-
RPA-38	1231	-

Model	Applicable to	
	TCMP	TCR TCR/R
RPA-42	1435	-
RPA-44	-	-
RPA-47	2050	1240
RPA-48	-	-
RPA-52	1845	1445
RPA-55	2050	1650
RPA-60	2050	1650
RPA-65	-	-
RPA-66	-	1856
RPA-73	-	2063
RPA-74	-	-
RPA-81	-	2271
RPA-88	-	2380
RPA-90	-	-
RPA-100	-	-

R/THT



Protection grille for the intake of THT series axial fans

Characteristics:

- Protects against contact with the impeller and prevents objects from entering in accordance with standard UNE-EN ISO 12499.
- Manufactured with electrowelded wire.

Model	Applicable to THT
R/THT-40	40
R/THT-45	45
R/THT-50	50
R/THT-56	56 (Motor size 80/90)
R/THT-56-1	56 (Motor size 100/112)
R/THT-63	63 (Motor size 80/90)
R/THT-63-1	63 (Motor size 100/112)
R/THT-63-2	63 (Motor size 132)
R/THT-63-3	63 (Motor size 160)
R/THT-71	71 (Motor size 80/90)
R/THT-71-1	71 (Motor size 100/112)
R/THT-80	80 (Motor size 90)
R/THT-80-1	80 (Motor size 100/112)
R/THT-80-2	80 (Motor size 132)
R/THT-90-1	90 (Motor size 100/112)
R/THT-90-2	90 (Motor size 132)

Model	Applicable to THT
R/THT-100	100 (Motor size 112)
R/THT-100-1	100 (Motor size 132)
R/THT-100-2	100 (Motor size 160)
R/THT-125	125 (Motor size 132)
R/THT-125-1	125 (Motor size 160)
R/THT-125-2	125 (Motor size 180)
R/THT-125-3	125 (Motor size 200)
R/THT-125-4	125 (Motor size 225/250)
R/THT-140	140 (Motor size 132/180)
R/THT-140-1	140 (Motor size 160/200)
R/THT-140-2	140 (Motor size 225/250)
R/THT-160	160 (Motor size 132/180)
R/THT-160-1	160 (Motor size 160/200)
R/THT-160-2	160 (Motor size 225/250)
R/THT-160-3	160 (Motor size 280)

ACCESSORIES



BTUB

Coupling flange for axial fans

Fan:

- Adapted to inlet and outlet.
- Facilitates installation on duct.

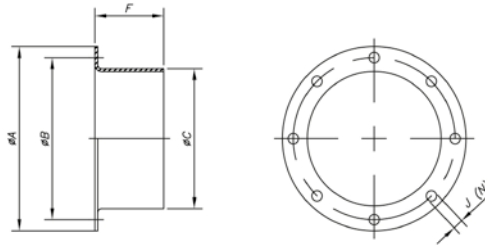

Model	$\varnothing A$	$\varnothing B$	$\varnothing C$	F	$\varnothing J$	N
BTUB-250	310	280	250	80	10	4x90°
BTUB-280	350	320	280	80	10	4x90°
BTUB-315	380	355	315	80	10	8x45°
BTUB-355	430	395	355	80	11	8x45°
BTUB-400	480	450	400	80	12	8x45°
BTUB-450	530	500	450	80	12	8x45°
BTUB-500	590	560	500	80	12	12x30°
BTUB-560	650	620	560	80	12	12x30°
BTUB-630	720	690	630	80	12	12x30°
BTUB-710	800	770	710	80	12	16x22°30'
BTUB-800	890	860	800	100	13	16x22°30'
BTUB-900	1000	970	900	100	15	16x22°30'
BTUB-1000	1100	1070	1000	100	15	16x22°30'
BTUB-1250	1365	1320	1250	100	15	20x18°
BTUB-1400	1520	1470	1400	100	15	20x18°
BTUB-1600	1740	1680	1600	100	19	24x15°



B

Coupling flange for centrifugal fans

Characteristics:

- Adapted to inlet and outlet.
- Facilitates installation on duct.

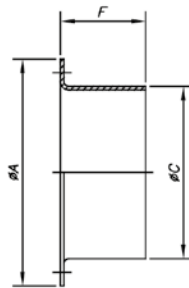

Model	$\varnothing A$	$\varnothing C$	F	Model	$\varnothing A$	$\varnothing C$	F
B-52-E	100	52	67	B-355/2	430	355	80
B-63	110	63	60	B-355/3	430	355	80
B-80	150	80	60	B-355/4	430	355	80
B-80-E	150	80	60	B-400/1	480	400	80
B-100	150	100	60	B-400/2	480	400	80
B-100-E	170	100	60	B-400/3	480	400	80
B-112	160	112	60	B-400/4	480	400	80
B-125	180	125	60	B-450/1	530	450	80
B-140	190	140	60	B-450/2	530	450	80
B-150	210	150	60	B-450/3	530	450	80
B-160	220	160	60	B-450/4	530	450	80
B-160/1	220	160	60	B-500/1	590	500	80
B-160/2	310	160	80	B-500/2	590	500	80
B-180	240	180	60	B-500/3	590	500	80
B-180/1	240	180	60	B-500/4	590	500	80
B-200	260	200	60	B-500/5	590	500	80
B-224	280	224	60	B-560/1	650	560	80
B-228	280	224	60	B-560/2	650	560	80
B-250/1	310	250	80	B-560/3	650	560	80
B-250/2	310	250	80	B-560/4	650	560	80
B-250/3	310	250	80	B-560/5	650	560	80
B-250/4	310	250	80	B-630/1	720	630	80
B-250/5	310	250	80	B-630/2	720	630	80
B-280/1	350	280	80	B-630/3	720	630	80
B-280/2	350	280	80	B-630/4	720	630	80
B-280/3	350	280	80	B-630/5	720	630	80
B-280/4	350	280	80	B-710/1	800	710	80
B-315/1	380	315	80	B-710/2	800	710	80
B-315/2	380	315	80	B-710/3	800	710	80
B-315/3	380	315	80	B-800	890	800	100
B-315/4	380	315	80	B-900/1	1000	900	100
B-355/1	430	355	80	B-1000/1	1100	1000	100

Applicable to

Model	CHT CVT	TCMP	TCR TCR/R
B-200	-	820	-
B-224	-	922	-
B-250/3	200/225	1025	-
B-280/2	-	1128	-
B-315/4	-	1231	-
B-355/3	250/315	1435	-
B-400/1	-	1640	-
B-400/2	-	-	1240
B-450/1	-	1845	-
B-450/2	-	-	1445
B-500/1	-	2050	-
B-500/2	-	-	1650
B-500/4	400/450	-	-
B-560/2	-	-	1856
B-630/2	-	-	2063
B-630/3	500	-	-
B-710/1	-	-	2271
B-710/2	560/630	-	-

ACCESSORIES



BD

Double coupling flange for centrifugal fans

Characteristics:

- It adapts to the suction mouth.
- Facilitates installation in duct with flange.

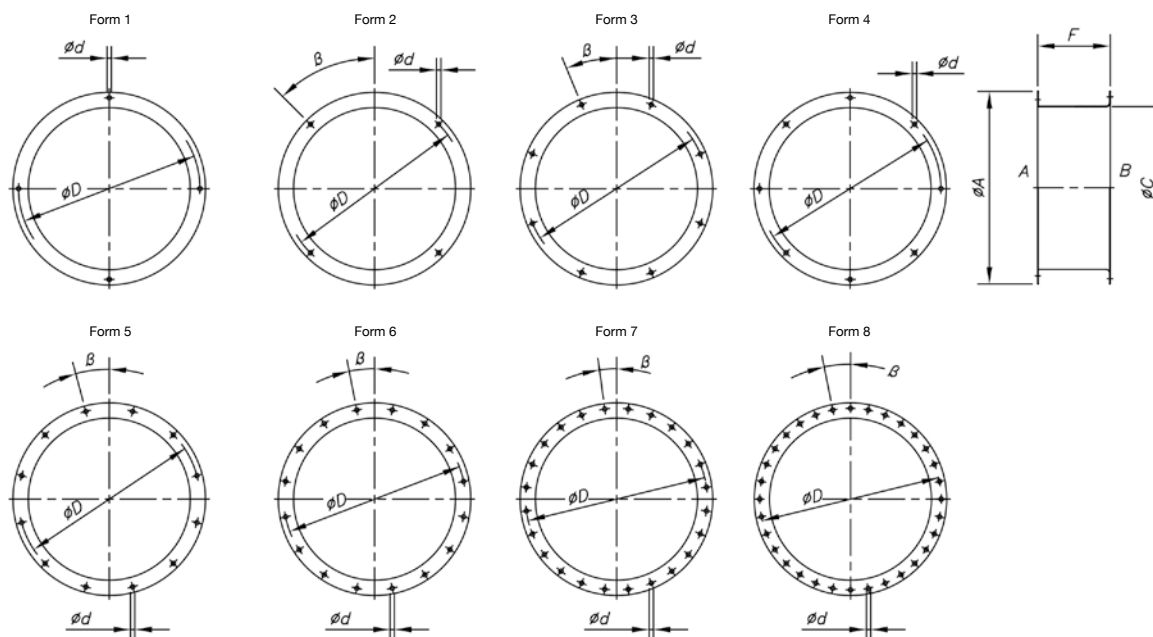

Model	ØA	ØC	ØD	Ød	F	β	Form	Applicable to	
								TCMP	TCR TCR/R
BD-112	160	112	137	7	60	45°	2		
BD-140	190	140	165	7	80	-	1		
BD-160	220	160	185	7	80	45°	2		
BD-160	220	160	185	7	80	-	1		
BD-180	240	180	205	7	80	11°15'	2		
BD-185	240	185	219	8	80	22°30'	3		
BD-200	260	200	225	7	80	-	1	820	
BD-200	260	200	225	7	80	22°30'	2		
BD-205	260	205	241	8	80	22°30'	3		
BD-224	280	224	254	7	80	-	1	922	
BD-228	280	228	265	8	80	22°30'	3		
BD-250/1	310	250	280	10	80	45°	2	1025	
BD-250/2	310	250	280	10	80	45°	2		
BD-255	310	255	292	10	80	22°30'	3		
BD-280	350	280	320	10	100	-	4	1128	
BD-285	350	285	332	10	100	22°30'	3		
BD-315/1	390	315	355	10	100	22°30'	3		
BD-315/2	390	315	355	10	100	22°30'	3		
BD-315/3	390	315	355	10	100	22°30'	3	1231	
BD-320	390	320	366	12	100	22°30'	3		
BD-355/1	430	355	395	10	100	22°30'	3		
BD-355/2	430	355	395	10	100	22°30'	3		
BD-355/3	430	355	395	10	100	22°30'	3	1435	
BD-360	430	360	405	12	100	22°30'	3		
BD-400/1	480	400	450	12	100	22°30'	3	1640	
BD-400/2	480	400	450	12	100	22°30'	3		1240

Model	ØA	ØC	ØD	Ød	F	β	Form	Applicable to	
								TCMP	TCR TCR/R
BD-405	480	405	448	12	100	15°	5		
BD-450/1	530	450	500	12	100	22°30'	3	1845	
BD-450/2	530	450	500	12	100	22°30'	3		1445
BD-455	530	455	497	12	100	15°	5		
BD-500/1	590	500	560	12	100	15°	5	2050	
BD-500/2	590	500	560	12	100	15°	5		1650
BD-505	590	505	551	12	100	15°	5		
BD-555	640	555	610	10	120	15°	5		
BD-560	650	560	620	12	120	15°	5		1856
BD-565	650	565	629	13	120	15°	5		
BD-630/1	720	630	690	12	120	15°	5		
BD-630/2	720	630	690	12	120	15°	5		2063
BD-635	720	635	698	15	120	15°	5		
BD-710	800	710	770	12	120	11°15'	6		2271
BD-715	800	715	775	15	120	11°15'	6		
BD-800	890	800	860	12	140	11°15'	6		
BD-805	890	805	861	15	140	11°15'	6		
BD-900/1	1000	900	958	14	140	11°15'	6		
BD-905	1000	905	958	14	140	11°15'	6		
BD-1000/1	1100	1000	1067	14	140	7°30'	7		
BD-1007	1100	1007	1067	15	140	7°30'	7		
BD-1130	1250	1130	1200	15	140	7°30'	7		
BD-1260	1380	1260	1337	15	160	7°30'	7		
BD-1410	1530	1410	1491	13	160	5°30'	8		
BD-1700	1820	1700	1770	16	180	5°30'	8		

ACCESSORIES

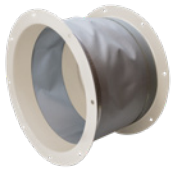

BAC

Double and elastic coupling flange for axial fans

Characteristics:

- Adapted to inlet and outlet.
- Facilitates installation in duct with flange.
- Prevents transmission of vibrations.

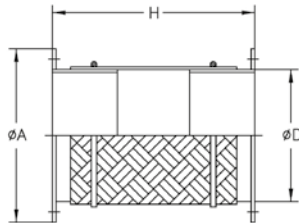

Model	ØD*	ØA*	H	Applicable to	
				CHT/CVT	THT
BAC-160	160	220	240	-	-
BAC-180	180	240	240	-	-
BAC-250	250	310	340	200/225	-
BAC-315B	280	350	340	-	-
BAC-315	315	380	340	-	-
BAC-355	355	430	340	250/315	-
BAC-400	400	480	340	-	40
BAC-450	450	530	340	-	45
BAC-500	500	590	340	400/450	50
BAC-560	560	650	340	-	56
BAC-630	630	720	340	500	63
BAC-710	710	800	340	560/630	71
BAC-800	800	890	340	-	80
BAC-900	900	1000	340	-	90
BAC-1000	1000	1100	340	-	100
BAC-1250	1250	1365	340	-	125

* Recommended nominal tube diameter

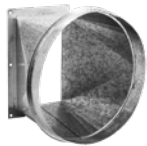

BIC

Conversion flange from rectangular to circular for centrifugal fans

Characteristics:

- Fits the outlet mouth.
- Facilitates installation on circular duct.

Model	Applicable to TCMP
BIC-820	820
BIC-922	922
BIC-1025	1025
BIC-1128	1128
BIC-1231	1231
BIC-1435	1435
BIC-1640	1640
BIC-1845	1845
BIC-2050	2050
BIC-2563	2563

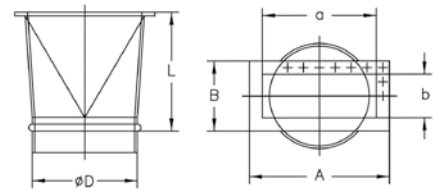

Model	L	D	a	b	A	B
BIC-540	300	180	140	120	224	206
BIC-545	300	180	170	135	255	222
BIC-550	300	224	200	150	296	246
BIC-752	300	224	200	160	296	256
BIC-760	300	250	220	180	316	276
BIC-880	300	315	290	190	360	249
BIC-270	300	270	300	162	370	221
BIC-1080	300	250	200	140	270	210
BIC-1090	300	280	224	160	294	230
BIC-1250	450	400	400	280	480	360
BIC-1456	450	450	450	315	530	395
BIC-1663	450	500	500	355	580	435
BIC-1671	450	630	560	400	660	500
BIC-2080	450	710	630	450	730	550
BIC-242	200	100	95	60	155	120
BIC-248	200	112	105	66	165	126
BIC-254	200	125	115	75	175	135
BIC-260	200	150	125	85	185	145
BIC-463	200	200	125	85	185	145
BIC-467	250	224	130	90	190	150
BIC-571	250	250	145	95	205	155
BIC-640	250	250	200	125	260	185
BIC-645	250	250	224	140	284	200
BIC-650	250	250	250	160	310	220
BIC-790	250	180	112	80	172	140
BIC-852	250	280	280	180	340	240
BIC-856	280	355	280	180	340	240
BIC-863	280	355	315	200	375	260
BIC-971	280	400	355	224	425	294
BIC-980	300	250	200	140	270	210
BIC-990	300	280	224	160	294	230
BIC-285	300	280	288	205	368	285

Model	L	D	a	b	A	B
BIC-320	300	320	322	229	402	309
BIC-450	300	450	404	288	484	368
BIC-185	300	180	166	117	236	187
BIC-200	300	200	185	131	255	201
BIC-230	300	230	207	148	277	218
BIC-250	300	250	231	166	301	236
BIC-280	300	280	258	185	328	255
BIC-325	300	320	288	205	368	285
BIC-360	300	360	322	229	402	309
BIC-400	300	400	361	256	441	336
BIC-1428	300	250	286	202	350	260
BIC-1733	300	280	339	240	415	315
BIC-2240	450	355	400	300	478	372
BIC-820-CB	300	200	160	130	213	184
BIC-1445/E	450	450	450	355	538	445
BIC-1650/E	450	500	500	400	590	490
BIC-1856/E	450	560	560	450	660	550
BIC-1025	300	250	250	165	314	229
BIC-1128	300	280	300	180	364	244
BIC-1231	300	315	320	200	384	266
BIC-1435	300	355	280	228	344	294
BIC-1640	300	400	320	250	404	336
BIC-1845	450	450	360	284	444	370
BIC-2050	450	500	450	315	545	412
BIC-2563	450	630	600	410	706	512
BIC-512	300	112	86	75	118	104
BIC-514	300	140	107	83	147	122
BIC-616	300	160	125	103	172	153
BIC-620	300	200	100	105	153	159
BIC-718	300	180	146	115	192	169
BIC-820	300	200	156	130	213	184
BIC-922	300	224	216	140	282	204

Model	L	D	a	b	A	B
BIC-1031	300	315	315	250	385	320
BIC-1135	450	355	355	280	425	350
BIC-1240	450	400	400	315	480	395
BIC-1445	450	450	450	355	540	445
BIC-1650	450	500	500	400	590	490
BIC-1856	450	560	560	450	660	550
BIC-2063	450	630	630	500	750	620
BIC-2271	450	710	710	560	840	690
BIC-2380	600	800	800	560	920	680
BIC-2590	600	900	900	630	1020	750
BIC-28100	600	1000	1000	710	1120	830
BIC-1120	600	1120	1130	801	1270	941
BIC-1200	600	1250	1267	898	1407	1038
BIC-1400	600	1400	1421	1007	1561	1147
BIC-355	300	350	361	256	441	336
BIC-560	450	560	569	404	669	504
BIC-635	450	630	638	453	738	553
BIC-710	450	710	715	507	815	607
BIC-1600	600	1600	1593	1130	1753	1290
BIC-1025-T	300	200	250	165	314	229
BIC-1128-T	300	224	300	180	364	244
BIC-1231-T	300	250	320	200	384	266
BIC-1435-T	300	280	280	228	344	294
BIC-1640-T	300	280	320	250	404	336
BIC-1845-T	450	355	360	284	444	370
BIC-2050-T	450	400	450	315	545	412
BIC-922-T	300	180	216	140	282	204
BIC-1840	150	370	273	210	353	303
BIC-2045	190	400	330	270	420	360
BIC-565	450	560	560	355	660	457
BIC-1650/M	500	500	507	361	587	441

ACCESSORIES



PS

Set of support feet for tubular fans

Characteristics:

- When attached to the flange, it facilitates anchoring on flat surfaces.

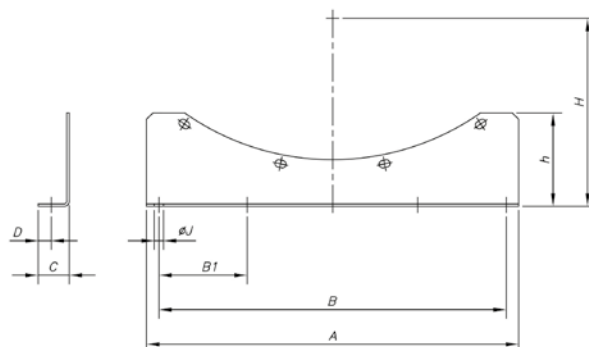

Model	A	B	B1	C	D	h	H	ØJ	Applicable to THT
PS-31/E	300	225	-	25	10.5	100	205	10	-
PS-25/31	275	225	-	25	10.5	90	165	10	-
PS-25/31	275	225	-	25	10.5	90	191.5	10	-
PS-25/31	275	225	-	25	10.5	90	205	10	-
PS-35/40	240	200	-	30	13	60	230	10	-
PS-35/40	240	200	-	30	13	60	255.5	10	40
PS-45/50	450	400	200	35	14.5	125	278	12	45
PS-45/50	450	400	200	35	14.5	125	305	12	50
PS-56/63	520	430	215	40	17	155	338	13	56
PS-56/63	520	430	215	40	17	155	385.5	13	63
PS-71	490	450	225	50	21	150	445	13	71
PS-80	600	560	280	50	21	150	490	13	80
PS-90	620	560	280	60	28	175	547.5	18	90
PS-100	680	560	280	60	28	185	597.5	18	100
PS-125 <20HP	1000	900	3x300	60	28	285	726.5	18	125
PS-125 >25HP	1000	900	3x300	60	28	285	726.5	18	125
PS-140	1100	1000	4x250	60	30	306	800	14	140
PS-160	1300	1200	4x300	60	25	290	890	14	160

MS



Support frame to facilitate mounting on site

Characteristics:

- Used to facilitate the assembly of the fan in construction ducts.

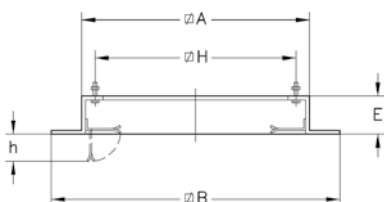

Model	∅A	∅B	E	∅H	h	Applicable to CHT/CVT
MS-348	348	520	60	295	70	-
MS-393	393	565	60	320	70	-
MS-443	443	615	60	360	70	200/225
MS-493	493	665	60	410	70	-
MS-553	553	725	60	450	70	250/315
MS-623	623	795	60	530	70	-
MS-701	701	875	60	590	90	400/450
MS-791	791	965	60	680	90	-
MS-891	891	1065	60	750	90	500
MS-991	991	1165	60	850	90	-
MS-1086	1086	1260	60	850	90	560/630
MS-1140	1140	1314	60	1000	90	-
MS-1240	1240	1414	60	1100	90	-

ACCESSORIES

PA



Adapter plate for mounting accessories, on roof extractors

Characteristics:

- Used to mount PT, B, BTUB, BAC accessories. Allows fan to be separated from its base without dismantling accessories.

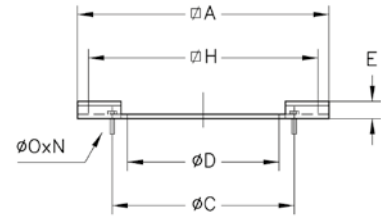

Model	∅A	∅C	∅D	E	∅H	∅O	N	Applicable to CHT/CVT
PA-345	345	200	165	20	295	M.8	4x90"	-
PA-390	390	210	190	20	320	M.8	4x90"	-
PA-440/250	440	280	249	20	360	M.6	4x90"	200/225
PA-490	490	355	314	20	410	M.8	8x45"	-
PA-550	550	395	354	20	450	M.6	8x45"	250/315
PA-620	620	450	399	20	530	M.10	8x45"	-
PA-700/500	700	560	499	20	590	M.10	12x30"	400/450
PA-700/450	700	500	449	20	590	M.10	8x45"	-
PA-790	790	560	499	20	680	M.10	12x30"	-
PA-890/630	890	690	629	20	750	M.10	12x30"	500
PA-890/560	890	620	559	20	750	M.10	12x30"	-
PA-990/630	990	690	629	20	850	M.10	12x30"	-
PA-990/710	990	770	709	20	850	M.10	16x22"30'	-
PA-1085	1085	770	709	20	850	M.10	16x22"30'	560/630
PA-1138/800	1138	860	799	25	1000	M.10	16x22"30'	-
PA-1138/900	1138	970	899	25	1000	M.12	16x22"30'	-
PA-1238	1238	1070	999	25	1100	M.12	16x22"30'	-

BS



High base plate

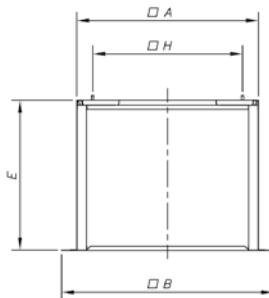

Model	A	B	H	E	Applicable to CHT/CVT
BS-348	348	520	295	800	-
BS-393	393	565	320	800	-
BS-443	444	611	360	800	200/225
BS-493	493	665	410	800	-
BS-553	554	724	450	800	250/315
BS-623	623	795	530	800	-
BS-701	701	871	590	900	400/450
BS-791	791	965	680	900	-
BS-891	891	1071	750	900	500
BS-991	991	1165	850	900	-
BS-1086	1086	1266	900	900	560/630
BS-1140	1136	1310	1000	900	-
BS-1240	1237	1411	1100	900	-

BSS



High base plate with silencer

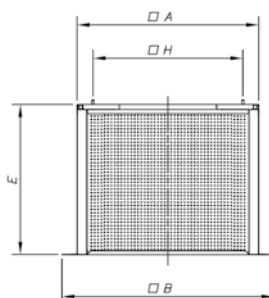

Model	A	B	H	E	Applicable to CHT/CVT
BSS-348	348	520	295	800	-
BSS-393	393	565	320	800	-
BSS-443	444	611	360	800	200/225
BSS-493	493	665	410	800	-
BSS-553	554	724	450	800	250/315
BSS-623	623	795	530	800	-
BSS-701	701	871	590	900	400/450
BSS-791	791	965	680	900	-
BSS-891	891	1071	750	900	500
BSS-991	991	1165	850	900	-
BSS-1086	1086	1266	900	900	560/630
BSS-1140	1136	1310	1000	900	-
BSS-1240	1237	1411	1100	900	-

ACCESSORIES

PT



Automatic closing shutters to work in vertical position. Version 400 certified 400 °C/2h

Characteristics:

- Circular self-closing shutters to be installed in the suction of roof extractors.
- Use of PA adaptor plate recommended for assembly.

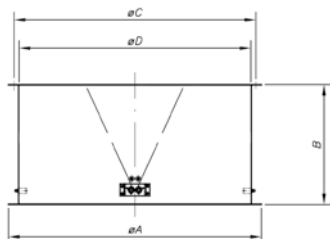

Model	øA	B	øC	øD	N	øO	Y
PT-160	220	150	200	150	8x45°	10	-
PT-180	240	150	210	170	8x45°	10	-
PT-250	310	150	280	245	4x90°	10	45
PT-355	435	200	395	350	8x45°	10	22°30'
PT-500	600	280	560	495	12x30°	12	15°
PT-630	730	355	690	625	12x30°	12	15°
PT-710	810	400	770	705	16x22°30'	12	11°15'

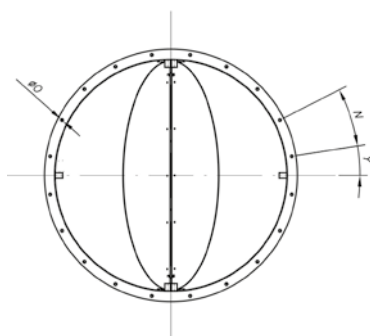

Model	øA	B	øC	øD	N	øO	Y	Applicable to CHT/CVT
PT-160-400	220	150	200	150	8x45°	10	-	-
PT-180-400	240	150	210	170	8x45°	10	-	-
PT-250-400	310	150	280	245	4x90°	10	45	200/225
PT-355-400	435	200	395	350	8x45°	10	22°30'	250/315
PT-500-400	600	280	560	495	12x30°	12	15°	400/450
PT-630-400	730	355	690	625	12x30°	12	15°	500
PT-710-400	810	400	770	705	16x22°30'	12	11°15'	560/630

PT/H



Automatic closing shutters to work in horizontal position. Version 400 certified 400 °C/2h

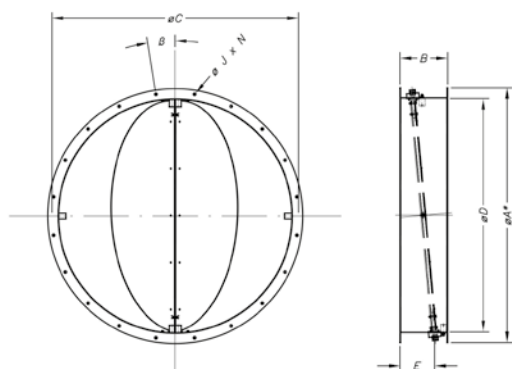

Model	øA	B	øC	øD*	E	F	øJ	N
PT-450/H PT-450/H-400	540	254	500	460	185	340	22°30'	12 8x45'
PT-500/H PT-500/H-400	600	254	560	514	185	346	15'	12 12x30'
PT-560/H PT-560/H-400	660	254	620	560	185	363	15'	12 12x30'
PT-630/H PT-630/H-400	730	254	690	640	185	409	15'	12 12x30'
PT-710/H PT-710/H-400	810	254	770	710	185	443	11°15'	12 16x22°30'
PT-800/H PT-800/H-400	900	254	860	800	185	488	11°15'	12 16x22°30'
PT-900/H PT-900/H-400	1015	254	970	900	185	555	11°15'	15 16x22°30'
PT-1000/H PT-1000/H-400	1115	254	1070	1000	185	609	11°15'	15 16x22°30'
PT-1250/H PT-1250/H-400	1365	254	1320	1250	185	736.5	9'	15 20x18'

* Recommended nominal tube diameter

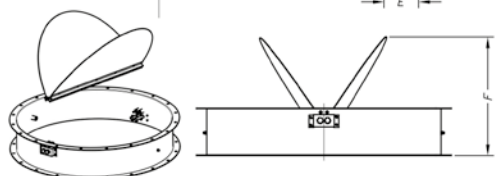

ACCESSORIES

VIS



Outlet hood with protection guard

Characteristics:

- Prevents objects and water from entering the fan.

Model	A	B	E	F	Applicable to	
					CJMP	CJTCR/R
VIS-820	132	157	170	56.5	820	-
VIS-922	142	216	215	56.5	922	-
VIS-1025	167	251	240	56.5	1025	-
VIS-1128	182	296	270	56.5	1128	-
VIS-1231	202	321	290	56.5	1231	-
VIS-1240	317	401	350	56.5	-	1240
VIS-1435	232	281	260	56.5	1435	-
VIS-1445	357	451	385	56.5	-	1445
VIS-1640	252	321	290	56.5	1640	-
VIS-1650	402	501	420	56.5	-	1650
VIS-1845	286	361	320	56.5	1845	-
VIS-1856	452	561	465	56.5	-	1856
VIS-2050	317	451	385	56.5	2050	-
VIS-2063	502	631	515	56.5	-	2063
VIS-2271	562	716	575	56.5	-	2271

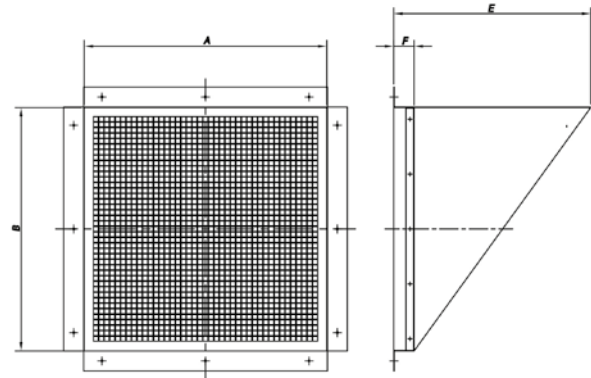

Model	A	B	E	F	Applicable to
					CJLINE
VIS-1131	560	450	250	100	1131
VIS-1235	620	500	250	100	1235
VIS-1640/E	710	560	250	100	1640
VIS-1845/E	800	630	250	100	1845
VIS-1856/E	1000	800	250	100	1856
VIS-2063/E	1120	900	250	100	2063
VIS-2271/E	1190	900	250	100	2271
VIS-2880	1250	1000	250	100	2880

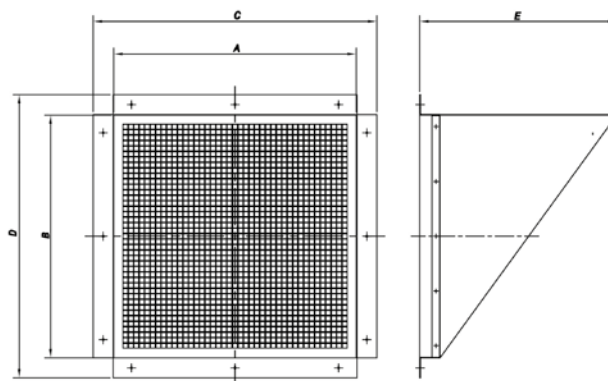

Model	A	B	C	D	E	Applicable to CJS
VIS-100	600	600	698	698	485	1850
VIS-200	725	725	823	823	576	2263-6T
VIS-300	800	800	898	898	630	2263-4T/ 2071-6T-3
VIS-400	860	860	958	958	674	2071-4T/6T-5.5/2880

ACCESSORIES

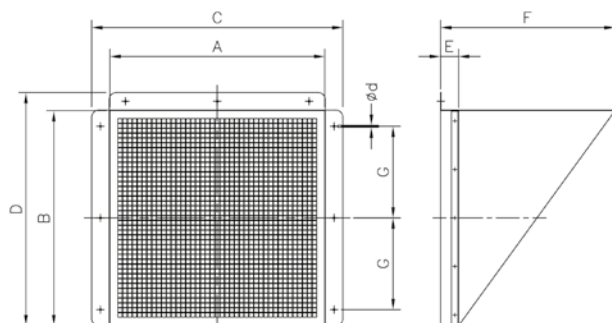

Model	Applicable to		
	CJBD	CJBDT	CJTX-C
VIS-7/7	1919	-	7/7
VIS-9/9	2525	9/9	9/9
VIS-10/10	2828	10/10	10/10
VIS-12/12	3333	12/12	12/12
VIS-15/15	3939	15/15	15/15
VIS-18/18	-	18/18	18/18
VIS-20/20	-	20/20	20/20
VIS-22/22	-	22/22	22/22
VIS-25/25	-	-	25/25
VIS-30/28	-	-	30/28

Model		A	B	C	D	E	F	G	Ød
VIS-7/7	VIS-7/7-P	300	280	334	314	50	200	200	6xØ5
VIS-9/9	VIS-9/9-P	370	370	404	404	50	250	200	6xØ5
VIS-10/10	VIS-10/10-P	400	360	434	394	50	250	240	6xØ5
VIS-12/12		490	470	524	504	50	250	170	9xØ5
	VIS-12/12-P	430	410	464	444	50	250	175	9xØ5
VIS-15/15	VIS-15/15-P	550	530	584	564	50	400	200	9xØ5
VIS-18/18	VIS-18/18-P	630	600	664	634	50	400	200	9xØ5
VIS-20/20	VIS-20/20-P	760	690	794	724	50	400	200	9xØ5
VIS-22/22		950	820	984	854	50	400	200	15xØ5
	VIS-22/22-P	820	820	854	854	50	400	180	15xØ5
VIS-25/25		820	820	854	854	50	400	180	15xØ5
	VIS-25/25-P	950	820	984	854	50	400	200	15xØ5
VIS-30/28	VIS-30/28-P	1040	1100	1074	1134	50	400	200	15xØ5



ACE ACE/400

Elastic coupling to dampen vibrations

Characteristics:

- It is used between the fan mouth and the duct to avoid the transmission of vibrations.
- It is advisable to add the B accessory at the inlet and BIC at the outlet, except in CPV models.

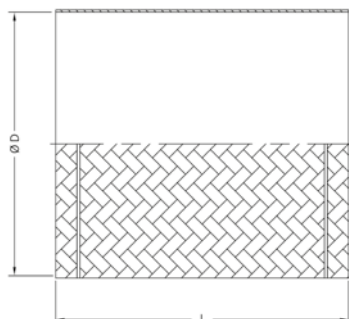

Model	ØD	L	Model	ØD	L	Applicable to					
						THT	CJMP	CJTGR/R			
ACE-52	52	200	ACE-355	355	300	ACE/400-200	200	200	-	820	-
ACE-63	63	200	ACE-400	400	300	ACE/400-224	224	200	-	922	-
ACE-80	80	200	ACE-450	450	300	ACE/400-250	250	300	-	1025	-
ACE-100	100	200	ACE-500	500	300	ACE/400-280	280	300	-	1128	-
ACE-112	112	200	ACE-560	560	300	ACE/400-315	315	300	-	1231	-
ACE-125	125	200	ACE-630	630	300	ACE/400-355	355	300	-	1435	-
ACE-140	140	200	ACE-710	710	300	ACE/400-400	400	300	40	1640	1240
ACE-150	150	200	ACE-800	800	300	ACE/400-450	450	300	45	1845	1445
ACE-160	160	200	ACE-900	900	300	ACE/400-500	500	300	50	2050	1650
ACE-180	180	200	ACE-1000	1000	300	ACE/400-560	560	300	56	-	1856
ACE-200	200	200	ACE-1130	1130	300	ACE/400-630	630	300	63	-	2063
ACE-224	224	200	ACE-1260	1260	300	ACE/400-710	710	300	71	-	2271
ACE-250	250	300	ACE-1410	1400	300	ACE/400-800	800	300	80	-	-
ACE-280	280	300	ACE-1610	1610	300	ACE/400-900	900	300	90	-	-
ACE-315	315	300				ACE/400-1000	1000	300	100	-	-
						ACE/400-1250	1250	300	125	-	-

ACCESSORIES



TEJ

Roof cover for outdoor

Characteristics:

- Avoids water entering ventilation units installed outside.

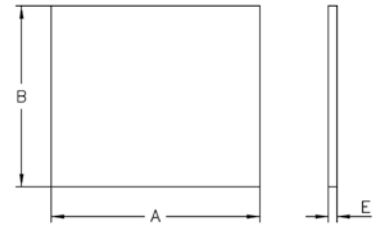

Model	A	B	E	Applicable to	
				CJMP	CJTCR/R
TEJ-820	500	550	25	820	-
TEJ-922	710	710	25	922	-
TEJ-1025	760	760	25	1025	-
TEJ-1128	820	820	25	1128	-
TEJ-1231	900	900	25	1231	-
TEJ-1435	980	980	25	1435	-
TEJ-1640	1071	1070	26	1640	1240
TEJ-1845	1170	1170	26	1845	1445
TEJ-1856	1360	1150	26	-	1856
TEJ-2050	1260	1260	26	2050	1650
TEJ-2063	1500	1300	26	-	2063
TEJ-2271	1655	1455	26	-	2271

Model	A	B	E	Applicable to	
				CJTX-C	
TEJ-7/7	710	740	30	7/7	
TEJ-9/9	770	795	30	9/9	
TEJ-10/10	835	870	30	10/10	
TEJ-12/12	955	980	30	12/12	
TEJ-15/15	1110	1110	30	15/15	
TEJ-18/18	1260	1290	30	18/18	
TEJ-20/20	1485	1505	30	20/20	
TEJ-22/22	1635	1650	30	22/22	
TEJ-25/25	1810	1835	30	25/25	
TEJ-30/28	2010	2145	30	30/28	

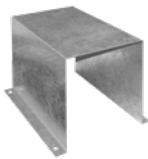

CM

Motor cover for outside work

Characteristics:

- Avoids water entering motors installed outside.

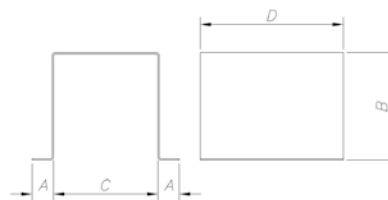

Model	A	B	C	D
CM-1	15	260	200	300
CM-2	15	260	240	300
CM-5.5	15	300	270	330
CM-10	15	380	320	450
CM-20	15	440	350	530
CM-30	15	440	360	550



TAC

Circular coupling cap

Characteristics:

- To convert the rectangular inlet or outlet of the models to circular.

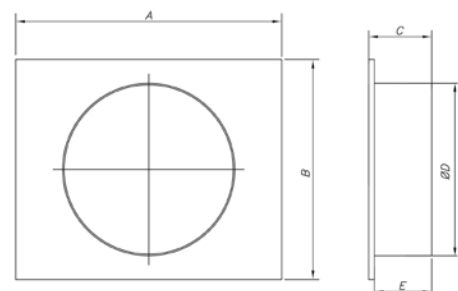

Model	A	B	C	ØD	E	Applicable to	
						CJS	CJLINE
TAC-100	698	698	80	400	50	1850	-
TAC-200	823	823	80	560	50	2056/2263-6T	-
TAC-300	898	898	80	630	50	2263-4T/2071-6T-3	-
TAC-400	958	958	80	710	50	2071-4T/6T-5.5/2880	-
TAC-1131	615	505	165	400	150	-	1131
TAC-1235	695	575	165	450	150	-	1235
TAC-1640	785	635	165	500	150	-	1640
TAC-1845	875	705	165	560	150	-	1845
TAC-1856	1075	875	165	700	150	-	1856
TAC-2063	1195	975	165	800	150	-	2063
TAC-2271	1265	975	165	800	150	-	2271
TAC-2880	1325	1075	165	900	150	-	2880

ACCESSORIES

S



Silencers to be coupled to the suction or discharge

Characteristics:

- Circular or rectangular silencers to be coupled to the inlet or outlet of centrifugal or helical fans.

Inlet/Impulsion (Rectangular flange)

Substitute shock absorption (dB) in octave bands (Hz)

Model	L	a	b	Kg	125	250	500	1000	2000	4000	Applicable to
SR-1000/900/900	900	1000	900	74	4	10	21	37	44	37	THT-63
SR-1200/900/900	900	1200	900	77	4	10	21	37	44	37	THT-71
SR-1400/1200/900	900	1400	1200	100	4	12	25	41	47	42	THT-80
SR-1800/1200/1200	1200	1800	1200	141	4	12	25	41	47	42	THT-90
SR-1800/1500/1200	1200	1800	1504	168	4	12	25	41	47	42	THT-100

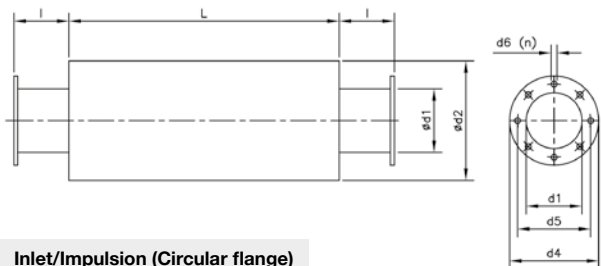
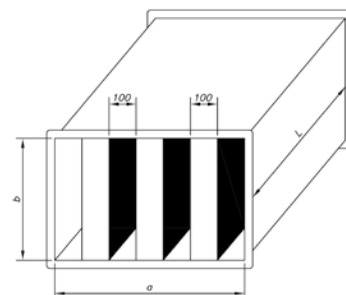

Inlet/Impulsion (Circular flange)

Substitute shock absorption (dB) in octave bands (Hz)

Model	L	d1	d2	l	d4	d5	d6	n	Kg	125	250	500	1000	2000	4000	Applicable to
SC-630/900	900	630	800	100	720	690	12	12x30°	51	5	8	14	12	13	9	THT-63
SC-710/900	900	710	900	100	800	770	12	16x22°30'	60	5	8	13	11	12	8	THT-71
SC-800/900	900	800	1000	100	900	860	12	16x22°30'	69	4	8	11	9	9	8	THT-80
SC-900/1200	1200	900	1120	100	1000	970	15	16x22°30'	100	5	7	11	11	7	5	THT-90
SC-1000/1200	1200	1000	1200	100	1100	1070	15	16x22°30'	106	4	7	11	10	7	6	THT-100

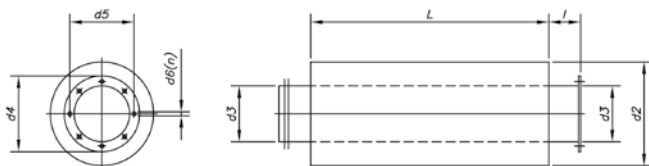

Inlet

Substitute shock absorption (dB) in octave bands (Hz)

Model	L	d2	d3	d4	d5	d6	n	l	Kg	125	250	500	1000	2000	4000	Applicable to
S-160/600-A	600	260	160	220	200	10	4x90°	100	9	3	11	22	33	42	29	-
S-180/600-A	600	300	180	240	210	10	4x90°	100	11	4	8	15	31	28	20	-
S-250/600-A	600	450	250	310	280	10	4x90°	100	18	5	12	20	24	23	14	CHT/CVT-200/225
S-315/900-A	900	500	315	390	355	10	8x45°	100	29	4	12	21	26	19	15	-
S-355/900-A	900	560	355	430	395	10	8x45°	100	34	4	12	20	24	18	14	CHT/CVT-250/315
S-400/900-A	900	600	400	480	450	12	8x45°	100	37	5	12	19	22	18	13	-
S-450/900-A	900	630	450	530	500	12	8x45°	100	38	5	12	18	20	16	12	-
S-500/900-A	900	710	500	590	560	12	12x30°	100	45	4	11	18	16	14	11	CHT/CVT-400/450
S-560/900-A	900	750	560	650	620	12	12x30°	100	47	4	10	16	14	13	10	-
S-630/900-A	900	800	630	720	690	12	12x30°	100	50	5	8	14	12	13	9	CHT/CVT-500
S-710/900-A	900	900	710	800	770	12	16x22°30'	100	58	5	8	13	11	12	8	CHT/CVT-560/630
S-800/900-A	900	1000	800	900	860	12	16x22°30'	100	67	4	8	11	9	9	8	-
S-900/1200-A	1200	1120	900	1000	970	12	16x22°30'	100	98	5	7	11	11	7	6	-
S-1000/1200-A	1200	1200	1000	1100	1070	12	16x22°30'	100	103	4	7	11	10	7	6	-

ACCESSORIES

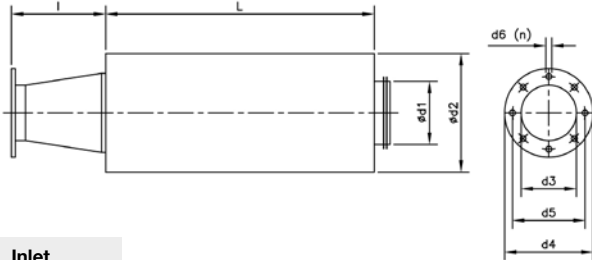

Inlet

Substitute shock absorption (dB) in octave bands (Hz)

Model	L	d1	d2	l	d3	d4	d5	d6	n	Kg	Substitute shock absorption (dB) in octave bands (Hz)						Applicable to
											125	250	500	1000	2000	4000	
S-80/600/218-A	600	80	280	103	80	113	95	6	4x90°	9	17	26	29	53	53	45	
S-100/600/324-A	600	100	300	108	80	130	112	6	4x90°	10	13	23	34	46	52	40	
S-125/600/325-A	600	125	315	114	94	140	122	7	4x90°	11	11	20	30	40	45	30	
S-150/600/426-A	600	150	355	132	117	155	132	7	4x90°	13	10	19	29	37	42	25	
S-150/600/527-A	600	150	355	114	125	170	147	7	4x90°	13	10	19	29	37	42	25	
S-160/600/528-A	600	160	355	107	135	190	162	7	4x90°	14	9	16	28	33	37	21	
S-200/600/531-A	600	200	400	135	160	215	180	7	4x90°	16	6	12	22	28	28	18	
S-250/600/540-A	600	250	450	204	170	240	205	11	4x90°	20	5	12	20	24	23	14	
S-315/900/545-A	900	315	500	266	180	255	220	11	4x90°	32	4	12	21	26	19	15	
S-100/600/242-A	600	100	300	115	100	150	130	10	8x45°	11	13	23	34	46	52	40	
S-150/900/248-A	900	150	355	200	112	160	140	10	8x45°	19	10	27	37	51	53	37	
S-160/900/254-A	900	160	355	200	125	180	155	10	8x45°	19	11	24	35	49	51	27	
S-200/900/260-A	900	200	400	200	150	210	175	10	8x45°	23	8	18	28	40	37	23	
S-200/900/463-A	900	200	400	200	200	260	240	10	8x45°	23	8	18	28	40	37	23	
S-250/900/467-A	900	250	450	200	224	280	258	10	8x45°	27	6	17	30	34	28	17	
S-250/900/571-A	900	250	450	200	250	310	275	10	8x45°	27	6	17	30	34	28	17	
S-250/600/640-A	600	250	450	200	250	310	275	10	8x45°	20	5	12	20	24	23	14	
S-315/900/645-A	900	315	500	200	250	310	275	10	8x45°	31	4	12	21	26	19	15	
S-355/900/650-A	900	355	560	200	250	310	275	10	8x45°	37	4	12	20	24	18	14	
S-180/900/680-A	900	180	380	100	165	235	200	11	8x45°	21	9	21	31	44	44	25	
S-180/900/790-A	900	180	380	100	185	235	219	11	8x45°	21	9	21	31	44	44	25	
S-355/900/852-A	900	355	560	200	280	350	310	10	8x45°	37	4	12	20	24	18	14	
S-400/1200/856-A	1200	400	600	200	355	430	395	10	8x45°	51	7	16	22	29	22	15	
S-400/1200/863-A	1200	400	600	200	355	430	410	10	8x45°	51	7	16	22	29	22	15	
S-450/1200/971-A	1200	450	630	200	400	480	450	12	8x45°	53	6	15	21	25	20	14	
S-250/1200/980-A	1200	250	450	100	255	325	292	11	8x45°	33	9	22	35	39	33	20	
S-280/1200/990-A	1200	280	450	100	286	366	332	11	8x45°	33	8	18	31	38	28	19	
S-250/1200/1080-A	1200	250	450	100	255	325	292	11	8x45°	33	9	22	35	39	33	20	
S-280/1200/1090-A	1200	280	450	100	286	366	332	11	8x45°	33	8	18	31	38	28	19	
S-500/900/1250-A	900	500	710	300	361	441	405	11.5	8x45°	54	6	13	18	15	15	12	
S-560/900/1456-A	900	560	750	450	406	486	448	11.5	12x30°	61	5	8	13	11	12	8	
S-630/1200/1663-A	1200	630	800	450	568	668	629	11.5	16x22°30'	79	4	8	11	9	9	8	
S-80/600/234-A	600	80	280	108	98	130	115	5	6x60°	10	17	26	29	53	53	45	
S-100/600/142-A	600	100	300	108	90	160	130	9	4x90°	11	13	23	34	46	52	40	
S-150/900/148-A	900	150	355	149	100	170	140	9	4x90°	19	10	27	37	51	53	37	
S-160/900/154-A	900	160	355	146	115	183	155	11	4x90°	19	11	24	35	49	51	27	
S-200/900/160-A	900	200	400	183	130	230	192	11	4x90°	23	8	18	28	40	37	23	
S-200/900/166-A	900	200	400	162	140	230	200	11	4x90°	23	8	18	28	40	37	23	
S-200/900/172-A	900	200	400	149	148	230	200	11	4x90°	23	8	18	28	40	37	23	
S-250/600/540-C-A	600	250	450	204	170	240	205	11	4x90°	20	5	12	20	24	23	14	
S-315/900/545-C-A	900	315	500	266	165	235	205	11	4x90°	32	4	12	21	26	19	15	
S-355/900/550-A	900	355	560	293	210	278	258	9	6x60°	38	4	12	20	24	18	14	
S-355/900/752-A	900	355	560	260	220	278	258	9	6x60°	38	4	12	20	24	18	14	
S-355/1200/760-A	1200	355	560	224	246	322	280	10	6x60°	47	7	15	25	32	23	17	
S-500/1200/880-A	1200	500	710	360	290	360	330	10	12x30°	69	7	15	25	32	23	17	
S-315/600/922-A	600	315	500	238	220	278	256	9	8x45°	24	4	8	14	17	14	12	TCMP-922
S-355/900/1025-A	900	355	560	224	245	305	282	9	8x45°	37	4	12	20	24	23	14	TCMP-1025
S-400/900/1128-A	900	400	600	250	270	348	320	9	8x45°	42	5	12	19	22	18	13	TCMP-1128
S-450/900/1231-A	900	450	630	291	295	382	354	9	8x45°	46	5	12	18	20	16	12	TCMP-1231
S-500/900/1435-A	900	500	710	284	345	422	394	9	8x45°	54	4	11	18	16	14	11	TCMP-1435
S-500/900/1640-A	900	500	710	227	395	464	438	9	8x45°	52	4	11	18	16	14	11	TCMP-1640

ACCESSORIES

Substitute shock absorption (dB) in octave bands (Hz)

Model	L	d1	d2	l	d3	d4	d5	d6	n	Kg	Substitute shock absorption (dB) in octave bands (Hz)						Applicable to
											125	250	500	1000	2000	4000	
S-560/900/1845-A	900	560	750	241	445	515	485	9	8x45°	56	4	10	16	14	13	10	TCMP-1845
S-630/1200/2050-A	1200	630	800	269	495	565	535	11	8x45°	77	6	13	18	15	15	12	TCMP-2050
S-800/1200/2563-A	1200	800	1000	370	595	710	675	14	8x45°	112	5	9	13	11	11	9	TCMP-2563
S-400/900/1031-A	900	400	600	202	320	383	356	9	8x45°	41	5	12	19	22	18	13	TCR-R-1031
S-450/900/1135-A	900	450	630	216	345	425	398	9	8x45°	44	5	12	18	20	16	12	TCR-R-1135
S-500/900/1240-A	900	500	710	227	395	472	444	11	8x45°	52	4	11	18	16	14	11	TCR-R-1240
S-560/900/1445-A	900	560	750	241	445	522	494	11	8x45°	56	4	10	16	14	13	10	TCR-R-1445
S-630/1200/1650-A	1200	630	800	269	495	582	555	11	8x45°	77	6	13	18	15	15	12	TCR-R-1650
S-710/900/1856-A	900	710	900	301	555	645	615	11	8x45°	75	5	8	13	11	12	8	TCR-R-1856
S-800/900/2063-A	900	800	1000	329	625	720	688	11	8x45°	88	4	8	11	9	9	8	TCR-R-2063
S-800/1200/2271-A	1200	800	1000	224	705	800	768	13	8x45°	100	5	9	13	11	11	9	TCR-R-2271
S-800/1200/2380-A	1200	800	1000	224	800	906	861	13	16x22°	92	5	9	13	11	11	9	TCR-R-2380

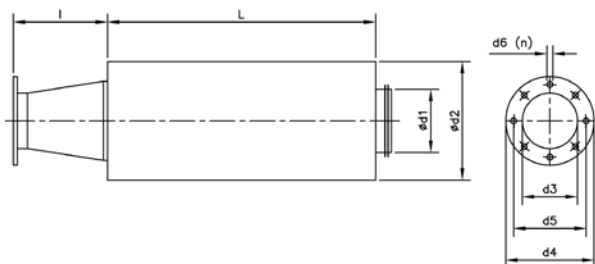

Impulsion (Circular flange)

Substitute shock absorption (dB) in octave bands (Hz)

Model	L	d1	d2	l	d3	d4	d5	d6	n	Kg	Substitute shock absorption (dB) in octave bands (Hz)					
											125	250	500	1000	2000	4000
S-80/600/218-I	600	80	280	103	54	90	76	6	4x90°	9	17	26	29	53	53	45
S-100/600/324-I	600	100	300	131	62	110	90	7	4x90°	10	13	23	34	46	52	40
S-125/600/325-I	600	125	315	142	80	120	102	7	4x90°	10	11	20	30	40	45	30
S-150/600/426-I	600	150	355	176	90	140	119	7	4x90°	12	10	19	29	37	42	25
S-150/600/527-I	600	150	355	149	100	155	129	7	4x90°	12	10	19	29	37	42	25
S-160/600/528-I	600	160	355	138	130	190	160	11	4x90°	12	9	16	28	33	37	21
S-200/600/531-I	600	200	400	162	140	200	175	11	4x90°	14	6	12	22	28	28	18
S-250/600/540-I	600	250	450	217	150	220	190	13	4x90°	17	5	12	20	24	23	14
S-315/900/545-I	900	315	500	266	175	250	220	13	4x90°	26	4	12	21	26	19	15
S-80/600/234-I	600	80	280	103	40	100	72	9	2x180°	9	17	26	29	53	53	45
S-100/600/142-I	600	100	300	131	60	120	90	11	4x90°	10	13	23	34	46	52	40
S-150/900/148-I	900	150	355	176	73	150	110	11	4x90°	17	10	27	37	51	53	37
S-160/900/154-I	900	160	355	190	80	160	120	13	4x90°	17	11	24	35	49	51	27
S-200/900/160-I	900	200	400	245	85	160	120	13	4x90°	20	8	18	28	40	37	23
S-200/900/166-I	900	200	400	245	85	160	120	13	4x90°	20	8	18	28	40	37	23
S-200/900/172-I	900	200	400	245	90	175	140	13	4x90°	20	8	18	28	40	37	23

ACCESSORIES

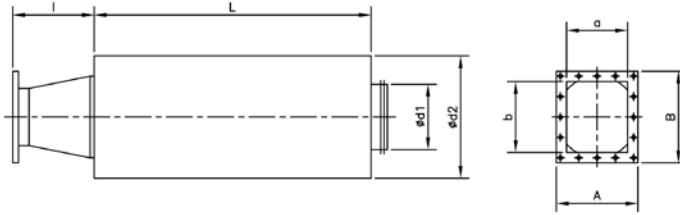

Impulsion (Rectangular flange)

Substitute shock absorption (dB) in octave bands (Hz)

Model	L	d1	d2	l	a	b	A	B	Kg	Substitute shock absorption (dB) in octave bands (Hz)						Applicable to
										125	250	500	1000	2000	4000	
S-100/600/242-I	600	100	300	200	95	60	155	120	10	13	23	34	46	52	40	
S-150/900/248-I	900	150	355	200	105	66	165	126	18	10	27	37	51	53	37	
S-160/900/254-I	900	160	355	200	115	75	175	135	18	11	24	35	49	51	27	
S-200/900/260-I	900	200	400	200	125	85	185	145	21	8	18	28	40	37	23	
S-200/900/463-I	900	200	400	200	125	85	185	145	21	8	18	28	40	37	23	
S-250/900/467-I	900	250	450	250	130	90	190	150	25	6	17	30	34	28	17	
S-250/900/571-I	900	250	450	250	145	95	205	155	25	6	17	30	34	28	17	
S-250/600/640-I	600	250	450	250	200	125	260	185	18	5	12	20	24	23	14	
S-315/900/645-I	900	315	500	250	224	140	284	200	28	4	12	21	26	19	15	
S-355/900/650-I	900	355	560	250	250	160	310	220	32	4	12	20	24	18	14	
S-180/900/680-I	600	180	380	100	71	100	131	160	14	9	21	31	44	44	25	
S-180/900/790-I	600	180	380	100	80	112	140	172	14	9	21	31	44	44	25	
S-355/900/852-I	900	355	560	250	280	180	340	240	32	4	12	20	24	18	14	
S-400/1200/856-I	1200	400	600	280	280	180	340	240	44	7	16	22	29	22	15	
S-400/1200/863-I	1200	400	600	280	315	200	375	260	44	7	16	22	29	22	15	
S-450/1200/971-I	1200	450	630	280	355	224	425	294	46	6	15	21	25	20	14	
S-250/1200/980-I	1200	250	450	100	140	200	210	270	30	9	22	35	39	33	20	
S-280/1200/990-I	1200	280	450	100	160	224	230	294	29	8	18	31	38	28	19	
S-250/1200/1080-I	1200	250	450	100	140	200	210	270	30	9	22	35	39	33	20	
S-280/1200/1090-I	1200	280	450	100	160	224	230	294	29	8	18	31	38	28	19	
S-500/900/1250-I	900	500	600	300	280	400	360	480	30	6	13	18	15	15	12	
S-560/900/1456-I	900	560	630	450	315	450	395	530	32	5	8	13	11	12	8	
S-630/1200/1663-I	1200	630	750	450	355	500	435	580	53	4	8	13	11	11	9	
S-250/600/540-C-I	600	250	450	300	140	120	224	206	18	5	12	20	24	23	14	
S-315/900/545-C-I	900	315	500	300	170	135	255	222	28	4	12	21	26	19	15	
S-355/900/550-I	900	355	560	300	200	150	296	246	33	4	12	20	24	18	14	
S-355/900/752-I	900	355	560	300	200	160	296	256	33	4	12	20	24	18	14	
S-355/1200/760-I	1200	355	560	300	220	180	316	276	41	7	15	25	32	23	17	
S-500/1200/880-I	1200	500	710	300	290	190	360	249	55	7	15	25	32	23	17	
S-315/600/922-I	600	315	500	300	216	140	282	204	21	4	8	14	17	14	12	TCMP-922
S-355/900/1025-I	900	355	560	300	250	165	314	229	33	4	12	20	24	23	14	TCMP-1025
S-400/900/1128-I	900	400	600	300	300	180	364	244	36	5	12	19	22	18	13	TCMP-1128
S-450/900/1231-I	900	450	630	300	320	200	384	266	37	5	12	18	20	16	12	TCMP-1231
S-500/900/1435-I	900	500	710	300	280	228	344	294	44	4	11	18	16	14	11	TCMP-1435
S-500/900/1640-I	900	500	710	300	320	250	404	336	44	4	11	18	16	14	11	TCMP-1640
S-560/900/1845-I	900	560	750	450	360	284	444	370	48	4	10	16	14	13	10	TCMP-1845
S-630/1200/2050-I	1200	630	800	450	450	315	545	412	62	6	13	18	15	15	12	TCMP-2050
S-800/1200/2563-I	1200	800	1000	450	600	410	706	512	83	5	9	13	11	11	9	TCMP-2563
S-400/900/1031-I	900	400	600	300	315	250	385	320	36	5	12	19	22	18	13	TCR-R/TCR-1031
S-450/900/1135-I	900	450	630	450	355	280	425	350	38	5	12	18	20	16	12	TCR-R/TCR-1135
S-500/900/1240-I	900	500	710	450	400	315	480	395	46	4	11	18	16	14	11	TCR-R/TCR-1240
S-560/900/1445-I	900	560	750	450	450	355	540	445	48	4	10	16	14	13	10	TCR-R/TCR-1445
S-630/1200/1650-I	1200	630	800	450	500	400	590	490	62	6	13	18	15	15	12	TCR-R/TCR-1650
S-710/900/1856-I	900	710	900	450	560	450	660	550	58	5	8	13	11	12	8	TCR-R/TCR-1856
S-800/900/2063-I	900	800	1000	450	630	500	750	620	67	4	8	11	9	9	8	TCR-R/TCR-2063
S-800/1200/2271-I	1200	800	1000	450	710	560	840	690	83	5	9	13	11	11	9	TCR-R/TCR-2271
S-800/1201/2380-I	1200	800	1000	450	560	800	680	920	83	5	9	13	11	11	9	TCR-R/TCR-2380

ACCESSORIES

SC



Silencers to be coupled to the suction or discharge

Characteristics:

- Circular silencers to be coupled to the inlet or outlet of in-line extractors.
- Silencers equipped with neck for coupling circular ducts.

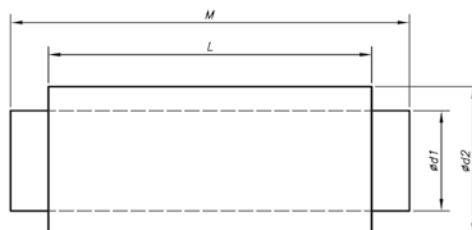

Acoustic attenuation

Model	Ød1	Ød2	L	M	Acoustic attenuation							
					63	125	250	500	1000	2000	4000	8000
SC-125	125	225	600	720	1.1	2.9	8.8	19.4	27.2	34.1	27.2	13.4
SC-160	160	260	600	720	1.0	2.9	7.2	16.5	23.4	29.6	20.3	9.2
SC-200	200	300	600	720	1.0	2.9	7.0	14.6	20.3	25.8	15.6	6.8
SC-250	250	355	600	720	0.2	2.1	7.2	12.5	18.8	23.0	10.3	5.2
SC-315	315	415	600	720	0.2	2.1	7.2	10.3	15.0	20.0	7.0	3.9
SC-355	355	450	700	820	3.6	4.2	6.5	13.2	14.2	4.0	7.9	7.2

SI-PIR



Motion detector

Automatically activates the ventilation system when it detects the presence of people in its range of action and remains in operation for a preset time, adjustable by internal clock.



Model	Power supply	Outlet	Detection angle	Adjusting devices	Installation height	Operating temperature
SI-PIR-TFT-550-B	24 V AC/24 V DC	24 V AC/24 V DC	110° C	Timer: 5 s-30 min	1.8-3.6 m	-20° +50° C
SI-PIR-TF-25-360	24 V AC/24 V DC	24 V AC/24 V DC	360° C	Timer: 10 s-30 min	2.4-4.2 m	-20° +50° C

SI-TEMP+HUMEDAD



Temperature and relative humidity sensor with display

It independently controls the temperature and relative humidity of the room's ambient air. Automatically activates the ventilation system when it detects a temperature or humidity higher than the set point. Once the ambient temperature or humidity has dropped below the set point, the fan remains in operation for a preset time, adjustable by means of an internal clock.

Model	Power supply	Outlet	Adjusting devices	Installation height	Operating temperature
SI-TEMP+HUMEDAD	24 V AC	0-10 V DC	$\Delta T = 0,5^{\circ}\text{C}$ and $\Delta \text{HR} = 2\%$	1.5-2.5 m	+10° +40° C

ACCESSORIES



SI-PRESIÓN

Pressure transmitter

Monitors the pressure in ventilation installations at constant pressure, and transforms it into an electrical signal, to regulate the ventilation system and always maintain the same pressure.

Model	Power supply	Outlet	Maximum consumption (VA)	Connectors Ø	Pressure range
SI-PRESIÓN TPDA	24 V AC/24 V DC	0-10 V/4-20 mA	4	6.2 mm	0-2500 Pa
SI-PRESIÓN TPDA c/DISPLAY	24 V AC/24 V DC	0-10 V/4-20 mA	4	6.2 mm	0-2500 Pa



SI-FUENTE DE ALIMENTACIÓN

24 V DC/AC power supply

It powers the 24 V AC/DC smart sensors from a single phase 230 V voltage input.



Model	Power supply	Outlet	Power (VA)
SI-FUENTE DE ALIMENTACIÓN DC	230 V	24 V DC	30
SI-FUENTE DE ALIMENTACIÓN AC	230/400 V	24/48 V AC	25



SI-VENT

Wind sensor

The SI-VENT electronic wind controller is a highly robust and reliable device, made up of a sensor, a controller and the power supply. The sensor is capable of measuring winds of up to 100 k.p.h. and the controller starts up the electrical extractor when the wind speed is below the programmed minimum wind value for five minutes.



SI-PRESOSTATO

Pressure sensor

Monitors the pressure difference between filters, once it reaches the selected value it triggers a contact to activate an alarm relay.

PDS LOBBY CONTROL

Control panel and independent automatic regulation for lobby pressurisation systems



Control panel and independent automatic regulation for lobby pressurisation systems in accordance with standard EN 12101-6, compatible with systems KIT BOXPDS and KIT BOXPDS SMART acting as remote pressure sensor and with automatic damper control to maintain overpressure in lobbies in case of fire.

The PDS LOBBY CONTROL panel includes:

- Built-in high precision differential pressure sensor.
- LCD screen and controls for programming all functions.
- Modbus RTU connection for communications with KIT BOXPDS and KIT BOXPDS SMART, or to connect with a BMS system.
- Activation from the fire panel via a configurable potential free contact.
- OPEN/CLOSE control of two independent motorised dampers for supply and/or exhaust air.

- Control of a motorised damper that opens proportionally according to a 0-10 VDC signal to supply or exhaust air.
- Manual activation via a configurable potential free contact.
- Local activation via an autonomous analogue 4-20 mA smoke sensor.
- Casing with IP54 protection rating.
- Working temperature range -10 °C +50 °C.
- Power supply: selectable between 230 V AC 50/60 Hz or 24 V DC.
- NO/NC configurable potential free relay outputs: STATUS (OK or FAULT).
- NO/NC configurable potential free relay outputs: Activation confirmation to the fire panel.

Easy system configuration via pushbutton control panel and LCD screen.

Technical characteristics

Model	Supply voltage	Nominal current	Pressure range	Operating temperature	Approx. weight	Protection class
	(V)	(A)	(Pa)	(°C)	(Kg)	
PDS LOBBY CONTROL	230 V AC 50/60 Hz	0.6	0-2500	-10 a +50	0.9	IP 54
	24 V DC	0.6	0-2500	-10 a +50	0.9	IP 54

Dimensions mm

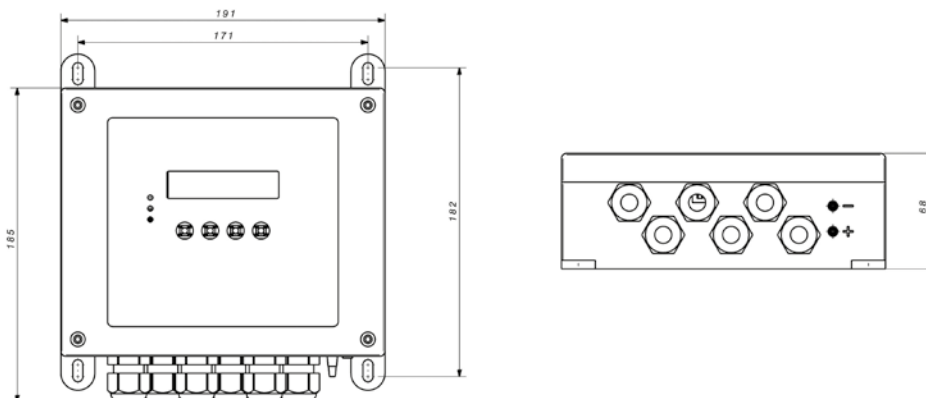

Connections

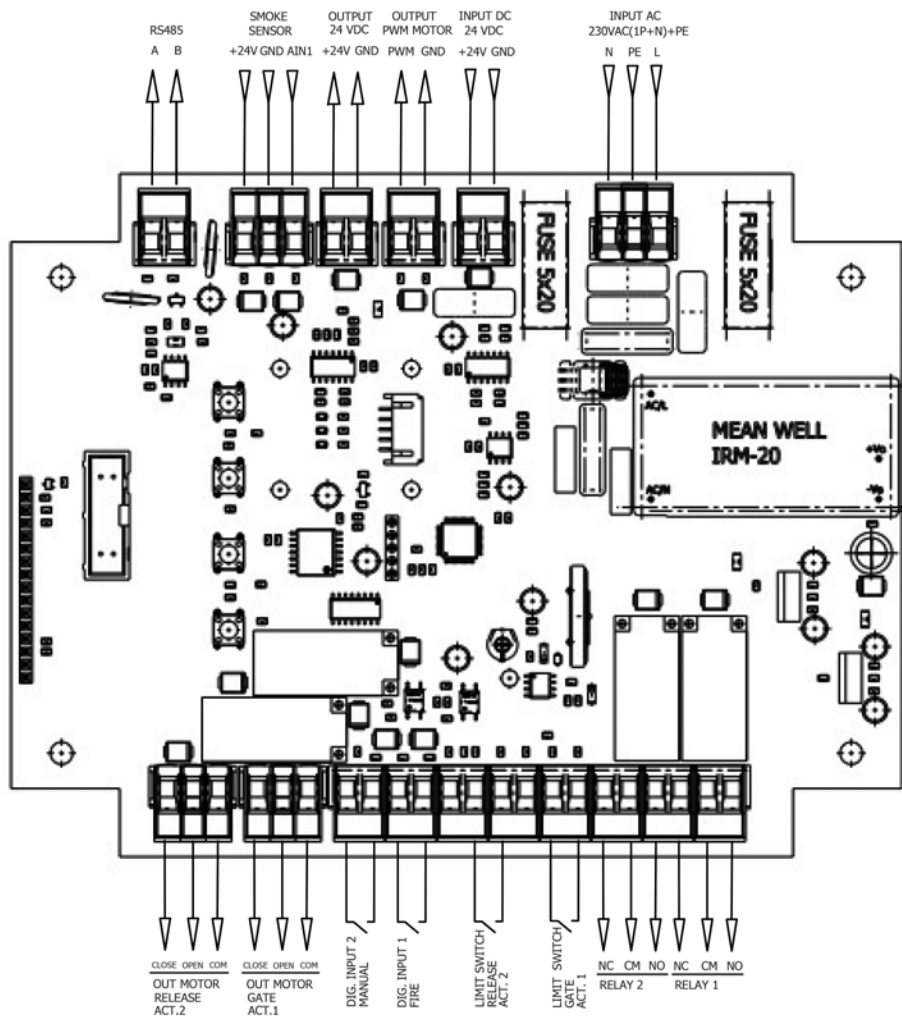

DAMPER BOX DAMPER BOX SMART



Motorized damper with built-in optical smoke detector for pressurization systems



DAMPER BOX

- Motorized damper with built-in analog optical smoke detector compatible with KIT BOXPDS pressurization systems.

DAMPER BOX SMART

- Motorized with high sensitivity optical smoke detector, with automatic reset and alarm management, compatible with KIT BOXSMART and KIT BOXPDS SMART pressurization systems.

Characteristics:

- Multiblade damper for air supply in pressurization systems.
- The damper fits directly on the CJHCH ventilation unit or in duct.
- Construction in galvanized steel sheet and aluminum sheet blades.
- Aerodynamic blades with opposed arrangement and sealing gasket.

- Optical smoke detector to ensure clean air intake. In case of smoke detection, the damper closes from the BOXSMART, KIT BOXPDS or KIT BOXPDS SMART pressurization control panel.
- Maintenance manhole cover.

Opening system:

- Opening and closing by fast damper actuator.
- Opening and closing time 2.5 seconds.
- Power supply AC/DC 24 V 50/60 Hz.
- Auxiliary contacts for monitoring of open or closed damper.

On request:

- DAMPER BOX AF and DAMPER BOX SMART AF with AntiFrost system with ultraviolet light heating element and adjustable thermostat to prevent frost build-up on the door in cold climates.

Order code

DAMPER BOX

—

56/63

—

AF



DAMPER BOX: Motorized with built-in optical smoke detector compatible with KIT BOXPDS pressurization systems

DAMPER BOX SMART: Motorized with built-in optical smoke detector compatible with KIT BOXSMART and KIT BOXPDS SMART pressurization systems.

Compatible fan diameter

AntiFrost system

Dimensions mm

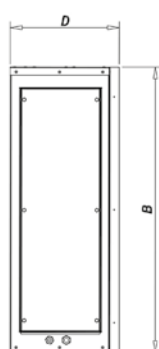
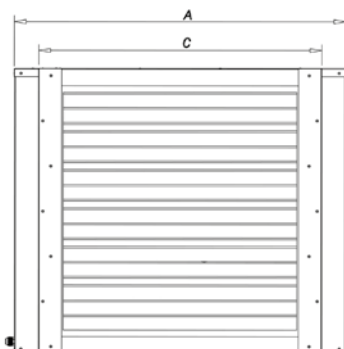

	A	B	C	D
DAMPER BOX 56/63	835	690	690	326.5
DAMPER BOX 71/80	995	850	850	326.5
DAMPER BOX 90/100	1195	1050	1050	326.5
DAMPER BOX SMART 56/63	835	690	690	350
DAMPER BOX SMART 71/80	995	850	850	350
DAMPER BOX SMART 90/100	1195	1050	1050	350

Bx C: Duct measurements.

SCDLS-MA

Single compartment smoke control dampers with manual and automatic operation



Characteristics:

- Rectangular gate from 200 x 200 mm to 1200 x 1200 mm.
- CE-certified according to EN 12101-8.
- Tested according to EN 1366-10.
- Cycle test class Cmod according to EN 12101-8.
- Damper actuation via 24 V or 230 V electric actuator.
- External casing leakage Class B, internal leakage Class 3 according to EN 1751.
- For vertical or horizontal installation.
- Classified according to EN 13501-4+A1 as EIS 120/600, acting MA or AA in single compartment.
- Maximum recommended velocity 12 m/s, allowable pressure up to 500 Pa, depression up to -1500 Pa.
- 250 mm wide damper.
- Designed for systems with automatic or manual activation.
- The damper is supplied with flanges.
- Working temperature: -30 °C +50 °C.

Order code

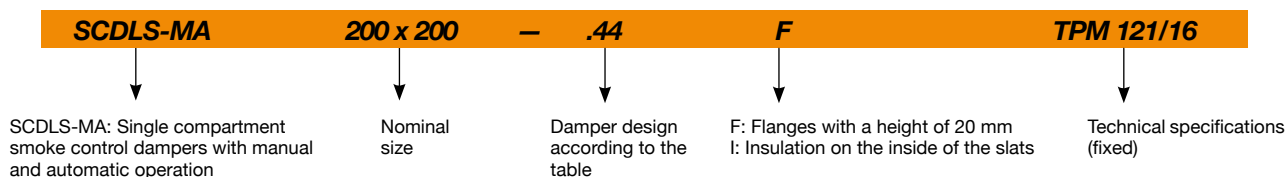

Damper design

Additional digit

With actuating mechanism BEN, BEE, BE for 230 V	.44
With actuating mechanism BEN, BEE, BE for 24 V	.54
With actuating mechanism BEN (BEE)-SR for 24 V	.65*
With the communication and supply device BKNE 230-24 and actuating mechanism BEN (BEE, BE)-ST for 24 V	.66

* Design .65 is not available by using BE actuator.

SCDRS-MA

Single compartment circular smoke control dampers with manual or automatic operation

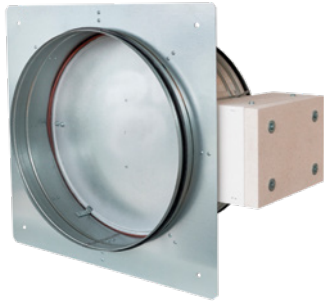

Characteristics:

- Circular damper from ø 100 to 630 mm.
 - CE-certified according to EN 12101-8.
 - Tested according to EN 1366-10.
 - Classified according to EN 13501-4+A1 as EIS 120/600, acting MA or AA in single compartment.
 - External enclosure leakage Class C, internal leakage Class 4.
 - Cycle test class Cmod according to EN 12101-8.
 - Damper actuation via 24 V or 230 V electric actuator.
- Recommended maximum speed 15 m/s, permissible pressure up to 500 Pa, or vacuum up to -1500 Pa.
 - Designed for systems with automatic or manual activation.
 - Working temperature: -30 °C +50 °C.

Order code

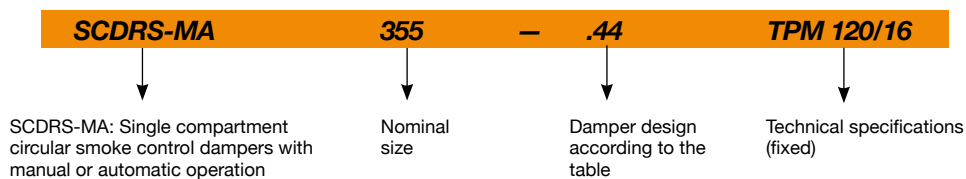

Damper design

Additional digit

With 230 V BEN actuator	.44
With 24 V BEN actuator	.54
With 24 V BEN-SR actuator	.65
With the communication and supply device BKNE 230-24 and actuating mechanism BEN-ST for 24 V	.66

SCDLM-MA

Multi-compartment smoke control dampers with manual and automatic activation



Characteristics:

- Rectangular fire damper from 200 x 430 mm to 1200 x 2030 mm.
- CE-certified according to EN 12101-8.
- 250 mm wide damper.
- Tested according to EN 1366-10.
- Classified according to EN 13501-4+A1 as EIS 120, with AA/MA positioning for Multi-compartment fire protection.
- Cycle test class Cmod according to EN 12101-8.
- External housing leakage Class C, internal leakage Class 3 according to EN 1751.
- Damper actuation via 24 V or 230 V electric actuator.
- Designed for systems with automatic or manual activation.
- Recommended maximum velocity 12m/s, allowable pressure up to 500 Pa, or vacuum up to -1000 Pa.
- The damper can be supplied with or without flanges.
- The dampers are only suitable for vertical installation with the blade axis in a horizontal position.
- Working temperature: -30 °C +50 °C.

Order code

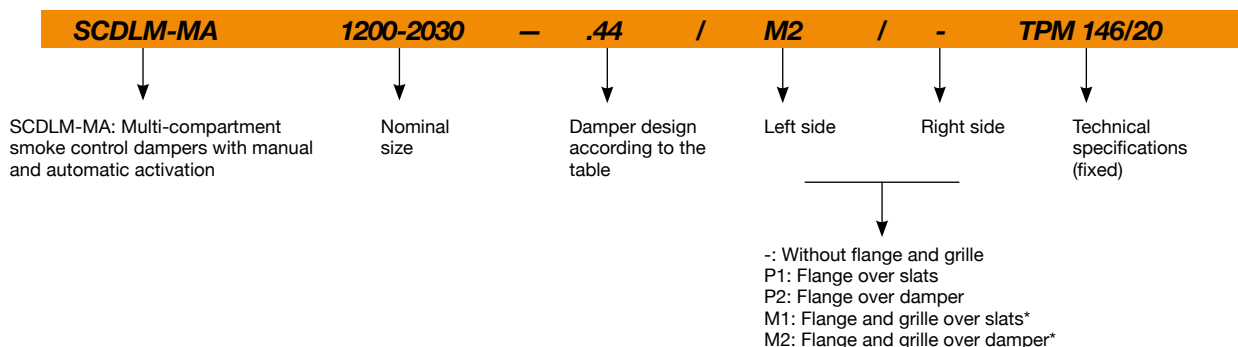

Damper design

Additional digit

With actuating mechanism BEN, BEE, BE for 230 V	.44
With actuating mechanism BEN, BEE, BE for 24 V	.54
With actuating mechanism BEN (BEE)-SR for 24 V	.65**
With the communication and supply device BKNE 230-24 and actuating mechanism BEN (BEE, BE)-ST for 24 V	.66

* Standard grille colour RAL 9006, other colours available on request.
** Design .65 is not available by using BE actuator.

ALPHABETICAL INDEX OF REFERENCES

BOXPRES PLUS	291
BOXPRES PLUS II	291
BOXSMART	271
BOXSMART EC	276
BOXSMART FLAP	281
BOXSMART II	271
CBDT	152
CHT	244
CHT/EC	248
CI	134
CJBDT	149
CJLINE	223
CJLINE/EC	227
CJMD	164
CJMP	193
CJS	161
CJSRX	216
CJSX	209
CJTCR/R	177
CJTCR/R/EW	182
CJTHT	112
CJTHT/ATEX	119
CJTHT/PLUS	107
CJTX-C	199
CJV/EW	155
CKD	232
CKDR	235
CKDR/EC	239
CVT	252
CVT/EC	256
HATCH PDS	266
HTMF	137
KIT BOXPDS	260
KIT BOXPDS II	260
KIT BOXPDS SMART	263
KIT BOXPDS SMART II	263
KIT BOXPRES PLUS	287
KIT BOXSMART	269
KIT BOXSMART EC	274
KIT BOXSMART FLAP	278
KIT BOXSMART II	269
KIT SOBREPRESIÓN	283
PRESSKIT	289
TCMP	188
TCR	158
TCR/R	168
TCR/R/EW	172
THT	27
THT/CL	77
THT/HATCH	99
THT/IMP	125
THT/ROOF	145
THT/WALL	86
THT/WALL-F	94
TUNEL JET FAN	131

ACCESSORIES

ACE ACE/400	310
AET	300
B	303
BAC	305
BD	304
BIC	305
BOXPARK	294
BS	307
BSS	307
BTUB	303
C2V	297
CABLE BOX	298
CENTRAL CO	300
CM	311
DAMPER BOX	320
DAMPER BOX SMART	320
IAT	297
INT	297
INT/ATEX	297
MS	306
P-400	301
PA	307
PDS LOBBY CONTROL	318
PS	306
PT	308
PT/H	308
R/THT	302
RM	298
RPA	302
RT	301
S	312
SC	316
SCDLM-MA	323
SCDLS-MA	321
SCDRS-MA	322
SI-FUENTE DE ALIMENTACIÓN	317
SI-PIR	316
SI-PRESIÓN	317
SI-PRESOSTATO	317
SI-TEMP+HUMEDAD	316
SI-VENT	317
TAC	311
TEJ	311
VIS	309
VSD3/A-RFT - VSD1/A-RFM	299



HEADQUARTER

Sodeca, S.L.U.
Pol. Ind. La Barricona
Carrer del Metall, 2
E-17500 Ripoll
Girona, SPAIN
Tel. +34 93 852 91 11
Fax: +34 93 852 90 42
General sales:
comercial@sodeca.com
Export sales:
ventilation@sodeca.com

PRODUCTION PLANT

Sodeca, S.L.U.
Ctra. de Berga, km 0,7
E-08580 Sant Quirze de
Besora
Barcelona, SPAIN
Tel. +34 93 852 91 11
Fax: +34 93 852 90 42
General sales:
comercial@sodeca.com
Export sales:
ventilation@sodeca.com



EUROPE

FINLAND
Sodeca Finland, Oy
HUIITTINEN
Sales and Warehouse
Mr. Kai Yli-Sipilä
Metsälinnankatu 26
FI-32700 Huittinen
Tel. + 358 400 320 125
orders.finland@sodeca.com

HELSINKI
Smoke Control Solutions
Mr. Antti Kontkanen
Vilppulantie 9C
FI-00700 Helsinki
Tel. +358 400 237 434
akontkanen@sodeca.com

HYVINKÄÄ
Smoke extraction and industrial
applications
Niinistökatu 12
FI-05800 Hyvinkää
Mr. Jaakko Tomperi
Tel. +358 451 651 333
jtomperi@sodeca.com
Mrs. Kaisa Partanen
Tel. +358 451 308 038
kpartanen@sodeca.com

ITALIA
Marelli Ventilazione, S.R.L.
Viale del Lavoro, 28
37036 San Martino B.A.
(VR), ITALY
Tel. +39 045 87 80 140
vendite@sodeca.com

PORTUGAL
Sodeca Portugal, Unip. Lda.
PORTO
Rua Veloso Salgado 1120/1138
4450-801 Leça de Palmeira
Tel. +351 229 991 100
geral@sodeca.pt

LISBOA
Pq. Emp. da Granja Pav. 29
2625-607 Vialonga
Tel. +351 219 748 491
geral@sodeca.pt

ALGARVE
Rua da Alegria, 33
8200-569 Ferreiras
Tel. +351 289 092 586
geral@sodeca.pt

UNITED KINGDOM
Sodeca Fans UK, Ltd.
Mr. Mark Newcombe
Tamworth Enterprise Centre
Philip Dix House, Corporation
Street, Tamworth, B79 7DN
UNITED KINGDOM
Tel. +44 (0) 1827 216 109
sales@sodeca.co.uk

AMERICA

CHILE
Sodeca Ventiladores, SpA.
Sra. Sofia Ormazábal
Santa Bernardita 12.005
(Esquina con Puerta Sur)
Bodegas 24 a 26,
San Bernardo, Santiago, CHILE
Tel. +56 22 840 5582
ventas.chile@sodeca.com

COLOMBIA
Sodeca Latam, S.A.S.
Sra. Luisa Stella Prieto
Calle7 No. 13 A-44
Manzana 4 Lote1, Montana
Mosquera, Cundinamarca
Bogotá, COLOMBIA
Tel. +57 1 756 4213
ventascolumbia@sodeca.co

PERU
Sodeca Perú, S.A.C.
Sr. Jose Luis Jiménez
C/ Mariscal Jose Luis de
Orbegoso 331. Urb. El pino.
15022, San Luis. Lima, PERÚ
Tel. +51 1 326 24 24
Cel. +51 994671594
comercial@sodeca.pe



HEADQUARTER

Sodeca, S.L.U.

Pol. Ind. La Barricona
Carrer del Metall, 2
E-17500 Ripoll
Girona, SPAIN
Tel. +34 93 852 91 11
Fax: +34 93 852 90 42
General sales: comercial@sodeca.com
Export sales: ventilation@sodeca.com

PRODUCTION PLANT

Sodeca, S.L.U.

Ctra. de Berga, km 0,7
E-08580 Sant Quirze de Besora
Barcelona, SPAIN
Tel. +34 93 852 91 11
Fax: +34 93 852 90 42
General sales: comercial@sodeca.com
Export sales: ventilation@sodeca.com



www.sodeca.com

