

HCH/ATEX

**Vahvarakenteiset seinäkiinnitteiset aksiaalipuhaltimet
ATEX-luokituksella**



Ilmoitettu organismi: LOM
Tunnistenumero: LOM 03ATEX0157
Moottorin merkintä:
Ⓜ II 2G Ex db IIB T4 Gb
Ⓜ II 2G Ex eb IIB T3 Gb
Ⓜ II 2D Ex tb IIC T135 °C Db



Aksiaalipuhaltimet pyöreällä seinäkiinnityslevyllä. ATEX-luokiteltu, II2G-laiteluokka, räjähdyspaineen kestävällä Ex db -moottorilla tai varmennetun rakenteen Ex eb -moottorilla, tai II2D-laiteluokka pölysuojatulla Ex tb -moottorilla.

Puhallin:

- Seinäkiinnitysleikka terästä, alumiinivanne siipipyörän kohdalla standardin EN 14986 mukaisesti.
- Siipipyörä alumiinivalua.
- Puhallussuunta moottorista siipipyörään päin.

Moottori:

- F-eristysluokan moottorit kuulalaakereilla ja ATEX-luokiteltu, räjähdyspaineen kestävä Ex db, varmennettu rakenne Ex eb tai pölysuojattu Ex tb.

- Kolmivaiheinen 230/400 V 50 Hz (4 kW moottoritukseen asti), tai 400/690 V 50 Hz (yli 4 kW moottoritiedoilla).
- Käyttölämpötila: -20 °C...+40 °C.

Pintakäsittely:

- Polyesterijauhemaalaa ATEX-käyttöön soveltuvalla maalilla, RAL 7032. Pohjakäsittelynä rasvanpoisto fosfaatitonta nanoteknologiaa käyttäen.

Pyynnöstä:

- PTC-termistorit käämeissä.
- Erikoiskäämytykset eri jännitteille ja taajuuksille.
- Puhaltimet 2-nopeusmoottorilla.
- Yksivaiheiset räjähdyspaineenkestävät Ex db moottorit.

Tilauskoodi

HCH/ATEX	—	56	—	4T	/	1,5	/	2G Ex eb
↓		↓		↓		↓		↓
HCH/ATEX: Vahvarakenteiset seinäkiinnitteiset aksiaalipuhaltimet ATEX-luokituksella		Siipipyörän halkaisija cm		Moottorin napojen määrä 2=3000 rpm 50 Hz 4=1500 rpm 50 Hz 6=1000 rpm 50 Hz T = Kolmivaiheinen		Moottoritieto (hv)		2G Ex eb: Pölysuojattu, tilaluokka 1 ja 2 2G Ex db: Pölysuojattu, tilaluokka 1 ja 2 2D Ex tb: Pölysuojattu, tilaluokka 21 ja 22

Tekniset ominaisuudet

Malli	Pyörimisnopeus (rpm)	Nimellisvirta (A)			Moottoritieto (kW)	Maks. ilmamäärä (m³/h)	Äänenpainetaso¹ dB (A)		Paino noin (Kg)	
		230V	400V	690V			Imupuoli	Ex eb	Ex db	
HCH/ATEX-35-2T	2770	1,62	0,93		0,37	5885	67	13	23	
HCH/ATEX-35-4T	1400	1,28	0,74		0,12	3210	49	12	19	
HCH/ATEX-40-2T-1.5	2850	3,93	2,26		1,10	8805	74	27	40	
HCH/ATEX-40-4T-0.33	1370	1,25	0,72		0,25	5175	54	21	30	
HCH/ATEX-45-4T-0.5	1370	2,60	1,50		0,37	7100	59	25	33	
HCH/ATEX-56-4T-0.75	1410	2,87	1,65		0,55	11040	65	32	46	
HCH/ATEX-56-4T-1	1410	3,81	2,20		0,75	12940	66	34	47	
HCH/ATEX-56-4T-1.5	1410	4,54	2,61		1,10	13995	67	36	55	
HCH/ATEX-56-4T-2	1400	6,93	4,00		1,50	15290	68	39	59	
HCH/ATEX-56-6T-0.33	910	2,42	1,40		0,25	8500	54	31	39	
HCH/ATEX-56-6T-0.5	935	2,77	1,60		0,37	9300	54	34	43	
HCH/ATEX-56-6T-0.75	930	3,46	2,00		0,55	9995	55	34	47	
HCH/ATEX-63-4T-1	1410	3,81	2,20		0,75	14145	68	43	56	

Tekniset ominaisuudet

Malli	Pyörimisnopeus (rpm)	Nimellisvirta (A)			Moottoriteho (kW)	Maks. ilmamäärä (m³/h)	Äänenpainetaso¹ dB (A)		Paino noin (Kg)	
		230V	400V	690V			lmupuoli	Ex eb	Ex db	
HCH/ATEX-63-4T-1.5	1410	4,54	2,61		1,10	17020	69	45	64	
HCH/ATEX-63-4T-2	1400	6,93	4,00		1,50	18910	70	48	68	
HCH/ATEX-63-4T-3	1410	8,30	4,77		2,20	22090	71	53	76	
HCH/ATEX-63-4T-4	1440	11,27	6,48		3,00	25390	72	56	79	
HCH/ATEX-63-6T-0.5	935	2,77	1,60		0,37	12135	59	43	52	
HCH/ATEX-63-6T-0.75	930	3,46	2,00		0,55	12760	60	43	56	
HCH/ATEX-71-4T-1.5	1410	4,54	2,61		1,10	19770	73	51	70	
HCH/ATEX-71-4T-2	1400	6,93	4,00		1,50	21090	74	54	74	
HCH/ATEX-71-4T-3	1410	8,30	4,77		2,20	23970	76	60	83	
HCH/ATEX-71-4T-4	1440	11,27	6,48		3,00	29410	77	63	86	
HCH/ATEX-71-6T-0.75	930	3,46	2,00		0,55	15130	62	49	62	
HCH/ATEX-71-6T-1	930	4,16	2,40		0,75	17260	63	51	70	
HCH/ATEX-71-6T-1.5	910	5,89	3,40		1,10	20965	64	54	75	
HCH/ATEX-80-4T-3	1410	8,30	4,77		2,20	27940	77	69	92	
HCH/ATEX-80-4T-4	1440	11,27	6,48		3,00	32720	78	72	95	
HCH/ATEX-80-4T-5.5	1450	15,29	8,79		4,00	37440	79	74	98	
HCH/ATEX-80-6T-1	930	4,16	2,40		0,75	20560	66	60	79	
HCH/ATEX-80-6T-1.5	910	5,89	3,40		1,10	24650	67	63	84	
HCH/ATEX-80-6T-2	940	7,62	4,40		1,50	27960	68	71	95	
HCH/ATEX-80-6T-3	940	9,35	5,40		2,20	32545	69	74	98	
HCH/ATEX-90-4T-4	1440	11,27	6,48		3,00	37635	83	87	110	
HCH/ATEX-90-4T-5.5	1450	15,29	8,79		4,00	41810	85	90	114	
HCH/ATEX-90-4T-7.5	1440		10,64	18,50	5,50	47550	87	103	142	
HCH/ATEX-90-4T-10	1450		14,39	25,03	7,50	53120	88	111	145	
HCH/ATEX-90-6T-3	940	9,35	5,40		2,20	35555	74	90	114	
HCH/ATEX-90-6T-4	945	14,72	8,50		3,00	40165	75	102	142	
HCH/ATEX-100-4T-7.5	1440		10,64	18,50	5,50	52470	90	115	154	
HCH/ATEX-100-4T-10	1450		14,39	25,03	7,50	58560	91	122	156	
HCH/ATEX-100-4T-15	1460		20,76	36,10	11,00	68000	92	159	256	
HCH/ATEX-100-4T-20	1450		28,19	49,03	15,00	71850	93	178	279	
HCH/ATEX-100-6T-3	940	9,35	5,40		2,20	40390	80	101	125	
HCH/ATEX-100-6T-4	945	14,72	8,50		3,00	46960	81	113	153	
HCH/ATEX-100-6T-5.5	950	18,88	10,90		4,00	52025	82	120	156	

1. Äänenpainetaso dB(A) 3 m etäisyydellä vapaassa kentässä.

Äänitiedot

Äänitehotasot Lw(A) [dB(A)] oktaavikaistoittain (Hz).
Arvot mitattu sisäntulon aikana enimmäisvirtausnopeudella

	63	125	250	500	1000	2000	4000	8000		63	125	250	500	1000	2000	4000	8000
HCH/ATEX-35-2T	48	63	82	81	82	81	76	67	HCH/ATEX-71-6T-0.75	44	64	72	77	79	76	69	58
HCH/ATEX-35-4T	30	45	64	63	64	63	58	49	HCH/ATEX-71-6T-1	45	65	73	78	80	77	70	59
HCH/ATEX-40-2T-1.5	55	70	89	88	89	88	83	74	HCH/ATEX-71-6T-1.5	46	66	74	79	81	78	71	60
HCH/ATEX-40-4T-0.33	35	50	69	68	69	68	63	54	HCH/ATEX-80-4T-3	59	79	87	92	94	91	84	73
HCH/ATEX-45-4T-0.5	33	50	62	70	75	75	71	64	HCH/ATEX-80-4T-4	60	80	88	93	95	92	85	74
HCH/ATEX-56-4T-0.75	47	67	75	80	82	79	72	61	HCH/ATEX-80-4T-5.5	61	81	89	94	96	93	86	75
HCH/ATEX-56-4T-1	48	68	76	81	83	80	73	62	HCH/ATEX-80-6T-1	48	68	76	81	83	80	73	62
HCH/ATEX-56-4T-1.5	49	69	77	82	84	81	74	63	HCH/ATEX-80-6T-1.5	49	69	77	82	84	81	74	63
HCH/ATEX-56-4T-2	50	70	78	83	85	82	75	64	HCH/ATEX-80-6T-2	50	70	78	83	85	82	75	64
HCH/ATEX-56-6T-0.33	36	56	64	69	71	68	61	50	HCH/ATEX-80-6T-3	51	71	79	84	86	83	76	65
HCH/ATEX-56-6T-0.5	36	56	64	69	71	68	61	50	HCH/ATEX-90-4T-4	65	86	93	98	101	97	90	79
HCH/ATEX-56-6T-0.75	37	57	65	70	72	69	62	51	HCH/ATEX-90-4T-5.5	67	88	95	100	103	99	92	81
HCH/ATEX-63-4T-1	50	70	78	83	85	82	75	64	HCH/ATEX-90-4T-7.5	69	90	97	102	105	101	94	83
HCH/ATEX-63-4T-1.5	51	71	79	84	86	83	76	65	HCH/ATEX-90-4T-10	70	91	98	103	106	102	95	84
HCH/ATEX-63-4T-2	52	72	80	85	87	84	77	66	HCH/ATEX-90-6T-3	56	77	84	89	92	88	81	70
HCH/ATEX-63-4T-3	53	73	81	86	88	85	78	67	HCH/ATEX-90-6T-4	57	78	85	90	93	89	82	71
HCH/ATEX-63-4T-4	54	74	82	87	89	86	79	68	HCH/ATEX-100-4T-7.5	72	92	100	105	107	104	97	86
HCH/ATEX-63-6T-0.5	41	61	69	74	76	73	66	55	HCH/ATEX-100-4T-10	73	93	101	106	108	105	98	87
HCH/ATEX-63-6T-0.75	42	62	70	75	77	74	67	56	HCH/ATEX-100-4T-15	74	94	102	107	109	106	99	88
HCH/ATEX-71-4T-1.5	55	75	83	88	90	87	80	69	HCH/ATEX-100-4T-20	75	95	103	108	110	107	100	89
HCH/ATEX-71-4T-2	56	76	84	89	91	88	81	70	HCH/ATEX-100-6T-3	62	82	90	95	97	94	87	76
HCH/ATEX-71-4T-3	58	78	86	91	93	90	83	72	HCH/ATEX-100-6T-4	63	83	91	96	98	95	88	77
HCH/ATEX-71-4T-4	59	79	87	92	94	91	84	73	HCH/ATEX-100-6T-5.5	64	84	92	97	99	96	89	78

Mitat mm

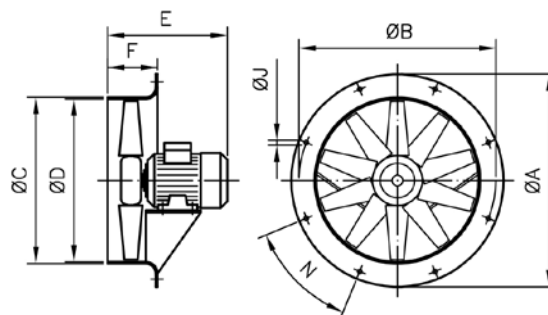

	Moottorin koko	ØA	ØB	ØC	ØD	E	F	ØJ	N
HCH/ATEX-35	71	425	395	358	355	279	110	10	8x45°
HCH/ATEX-35	63	425	395	358	355	279	110	10	8x45°
HCH/ATEX-35	56	425	395	358	355	279	110	10	8x45°
HCH/ATEX-40	71	490	450	414	410	305	120	12	8x45°
HCH/ATEX-40	80	490	450	414	410	342	120	12	8x45°
HCH/ATEX-45	71	540	500	464	460	295	120	12	8x45°
HCH/ATEX-56	80	660	620	564	560	326	120	12	12x30°
HCH/ATEX-56	90S	660	620	564	560	389	120	12	12x30°
HCH/ATEX-56	90L	660	620	564	560	389	120	12	12x30°
HCH/ATEX-56	71	660	620	564	560	317	120	12	12x30°
HCH/ATEX-63	80	730	690	645	640	337	150	12	12x30°
HCH/ATEX-63	90S	730	690	645	640	396	150	12	12x30°
HCH/ATEX-63	90L	730	690	645	640	396	150	12	12x30°
HCH/ATEX-63	100L	730	690	645	640	419	150	12	12x30°
HCH/ATEX-71	90S	810	770	715	710	397	150	12	16x22°30'
HCH/ATEX-71	90L	810	770	715	710	397	150	12	16x22°30'
HCH/ATEX-71	100L	810	770	715	710	424	150	12	16x22°30'
HCH/ATEX-71	80	810	770	715	710	334	150	12	16x22°30'
HCH/ATEX-80	100L	900	860	805	800	432	180	12	16x22°30'
HCH/ATEX-80	112M	900	860	805	800	455	180	12	16x22°30'
HCH/ATEX-80	90S	900	860	805	800	414	180	12	16x22°30'
HCH/ATEX-80	90L	900	860	805	800	414	180	12	16x22°30'
HCH/ATEX-90	100L	1015	970	906	900	477	180	15	16x22°30'
HCH/ATEX-90	112M	1015	970	906	900	458	180	15	16x22°30'
HCH/ATEX-90	132S	1015	970	906	900	572	180	15	16x22°30'
HCH/ATEX-90	132M	1015	970	906	900	512	180	15	16x22°30'
HCH/ATEX-100	132S	1115	1070	1006	1000	579	200	15	16x22°30'
HCH/ATEX-100	132M	1115	1070	1006	1000	518	200	15	16x22°30'
HCH/ATEX-100	112M	1115	1070	1006	1000	438	200	15	16x22°30'
HCH/ATEX-100	160M	1115	1070	1006	1000	608	200	15	16x22°30'
HCH/ATEX-100	160L	1115	1070	1006	1000	652	200	15	16x22°30'

Mitat pätevät Ex eb moottorilla.

Moottorin runkokoko moottoritehon mukaan (1 pyörimisnopeus)

	HV													
	0.13	0.33	0.5	0.75	1	1.5	2	3	4	5.5	7.5	10	15	20
2T (3000 rpm)	56	63	71	71	80	80	90S	90L	100L	112M	132S	132S	160M	160M
4T (1500 rpm)	56	71	71	80	80	90S	90L	100L	100L	112M	132S	132M	160M	160L
6T (1000 rpm)	63	71	80	80	90S	90L	100L	112M	132S	132M	132M	160M	160L	180L

Ominaiskäyrät

Q= Ilmamäärä m³/h, m³/s ja cfm

Pe= Staattinen paine mmH₂O, Pa ja inWG

2T=3000 rpm

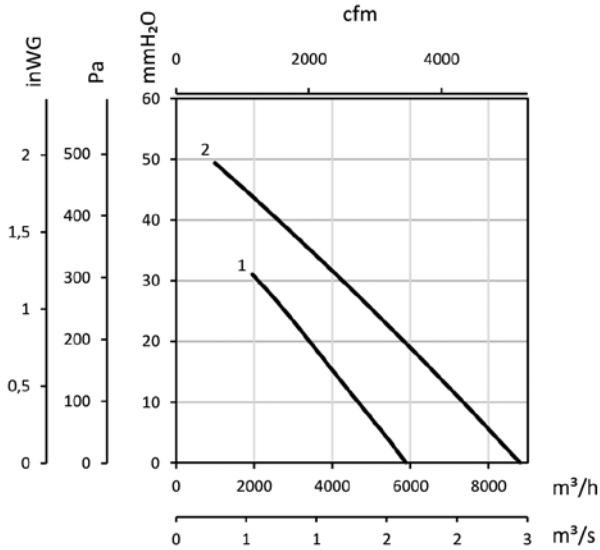

1 : HCH/ATEX-35-2T
2 : HCH/ATEX-40-2T-1.5

4T=1500 rpm

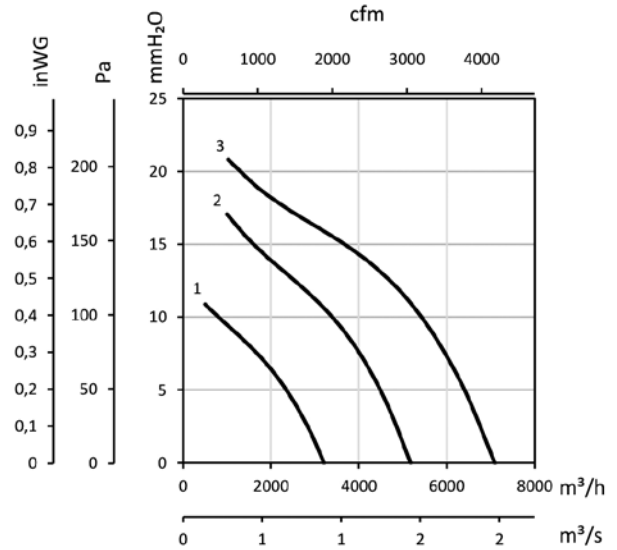

1 : HCH/ATEX-35-4T
2 : HCH/ATEX-40-4T-0.33
3 : HCH/ATEX-45-4T-0.5

4T=1500 rpm

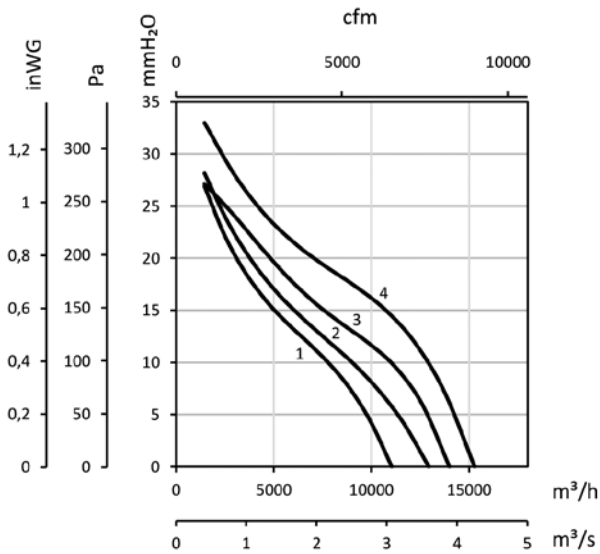

1 : HCH/ATEX-56-4T-0.75
2 : HCH/ATEX-56-4T-1
3 : HCH/ATEX-56-4T-1.5
4 : HCH/ATEX-56-4T-2

4T=1500 rpm

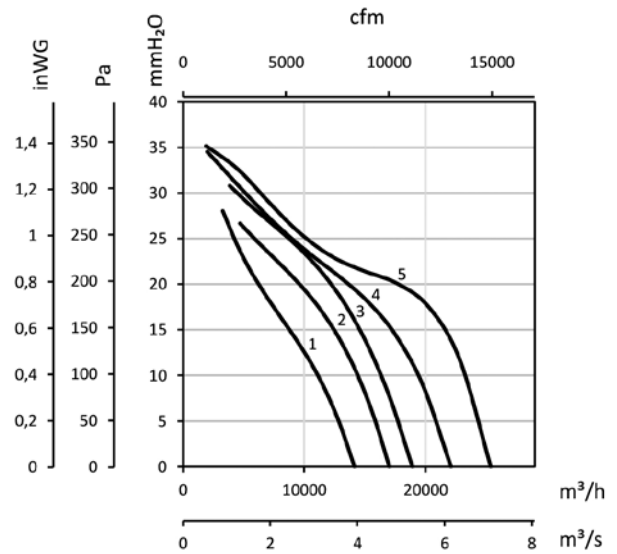

1 : HCH/ATEX-63-4T-1
2 : HCH/ATEX-63-4T-1.5
3 : HCH/ATEX-63-4T-2
4 : HCH/ATEX-63-4T-3
5 : HCH/ATEX-63-4T-4

Ominaiskäyrät

Q= Ilmamäärä m³/h, m³/s ja cfm

Pe= Staattinen paine mmH₂O, Pa ja inwg

4T=1500 rpm

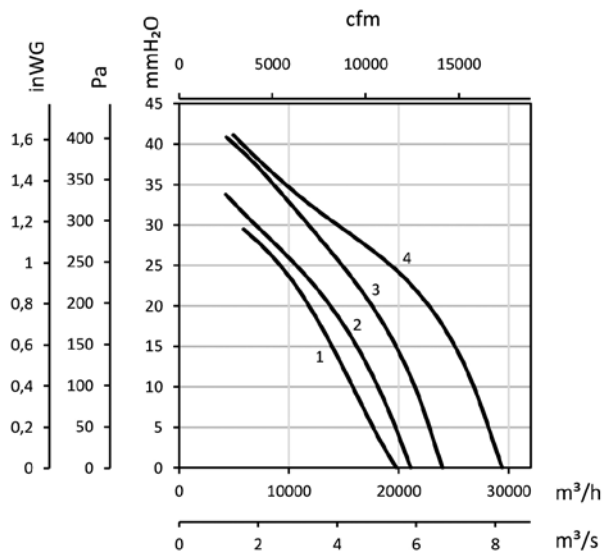

- 1 : HCH/ATEX-71-4T-1.5
- 2 : HCH/ATEX-71-4T-2
- 3 : HCH/ATEX-71-4T-3
- 4 : HCH/ATEX-71-4T-4

4T=1500 rpm

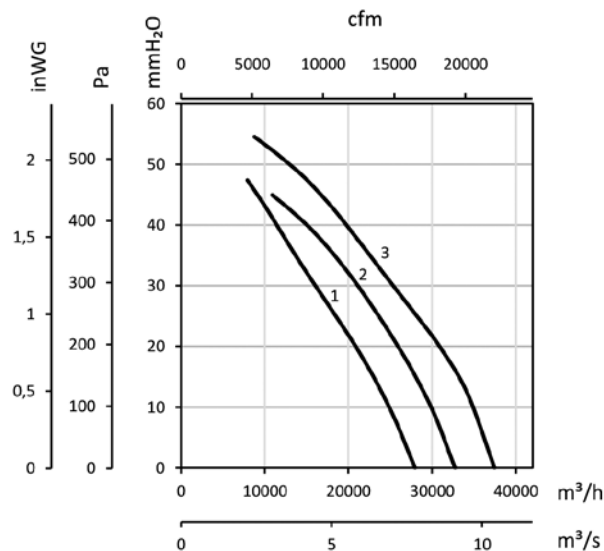

- 1 : HCH/ATEX-80-4T-3
- 2 : HCH/ATEX-80-4T-4
- 3 : HCH/ATEX-80-4T-5.5

4T=1500 rpm

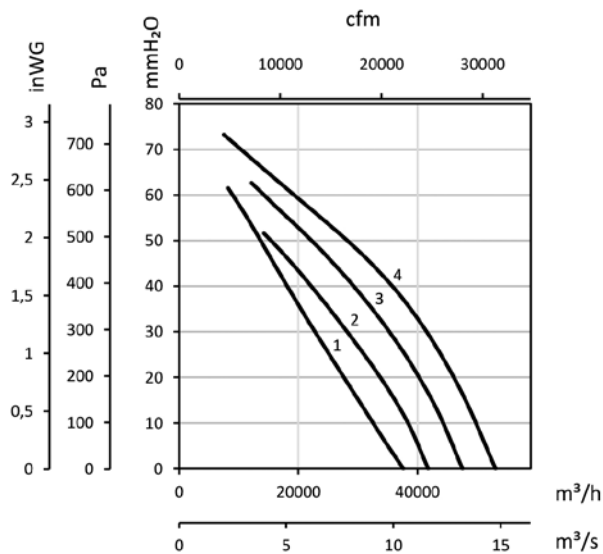

- 1 : HCH/ATEX-90-4T-4
- 2 : HCH/ATEX-90-4T-5.5
- 3 : HCH/ATEX-90-4T-7.5
- 4 : HCH/ATEX-90-4T-10

4T=1500 rpm

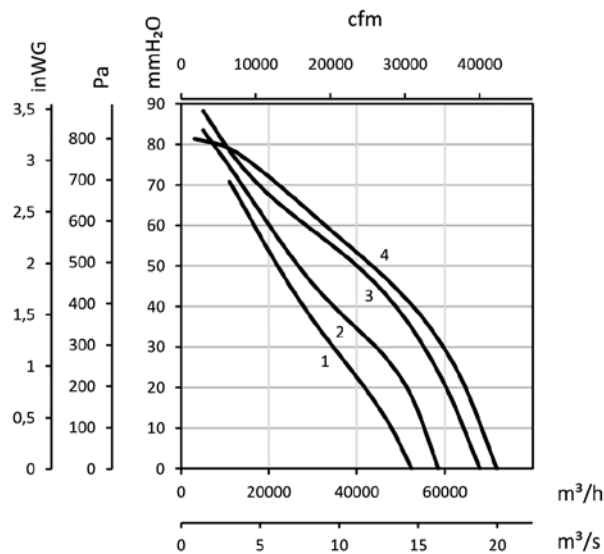

- 1 : HCH/ATEX-100-4T-7.5
- 2 : HCH/ATEX-100-4T-10
- 3 : HCH/ATEX-100-4T-15
- 4 : HCH/ATEX-100-4T-20

Ominaiskäyrät

Q= Ilmamäärä m³/h, m³/s ja cfm

Pe= Staattinen paine mmH₂O, Pa ja inwg

6T=1000 rpm

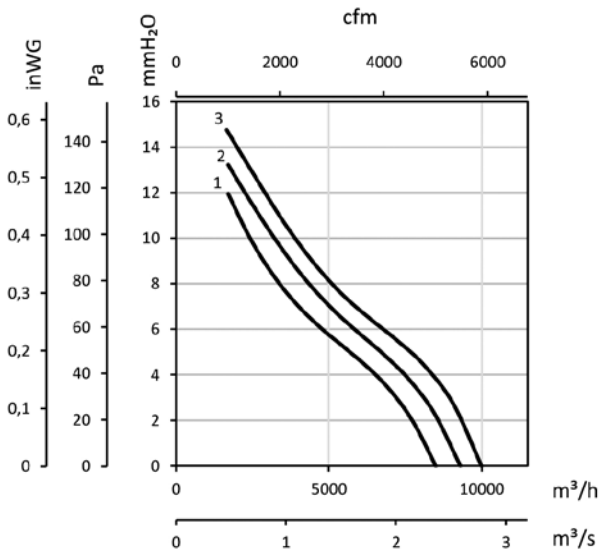

1 : HCH/ATEX-56-6T-0.33
2 : HCH/ATEX-56-6T-0.5
3 : HCH/ATEX-56-6T-0.75

6T=1000 rpm

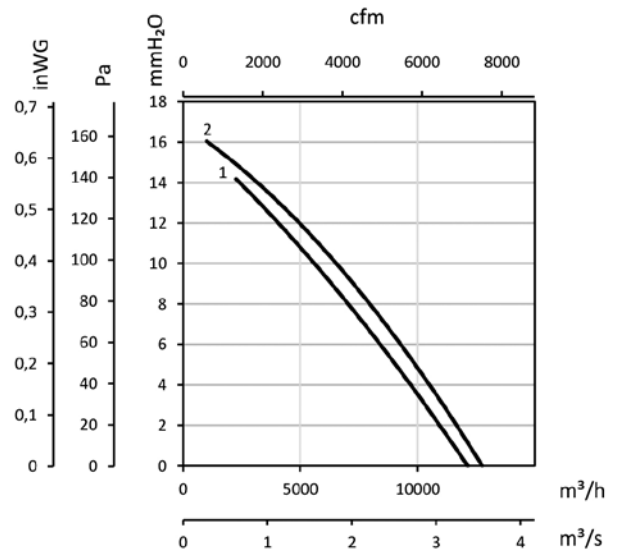

1 : HCH/ATEX-63-6T-0.5
2 : HCH/ATEX-63-6T-0.75

6T=1000 rpm

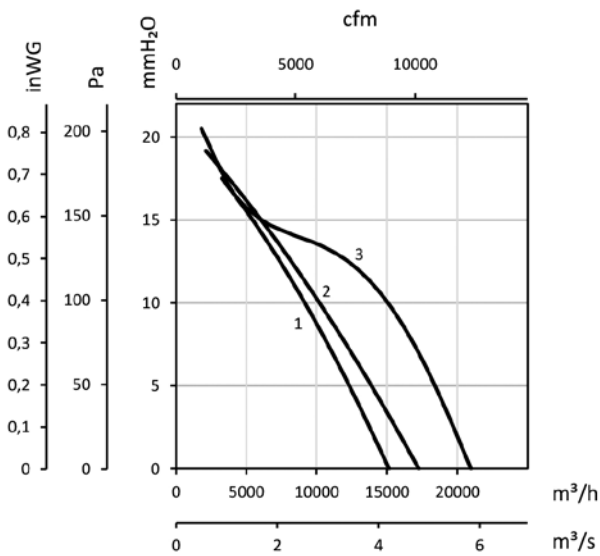

1 : HCH/ATEX-71-6T-0.75
2 : HCH/ATEX-71-6T-1
3 : HCH/ATEX-71-6T-1.5

6T=1000 rpm

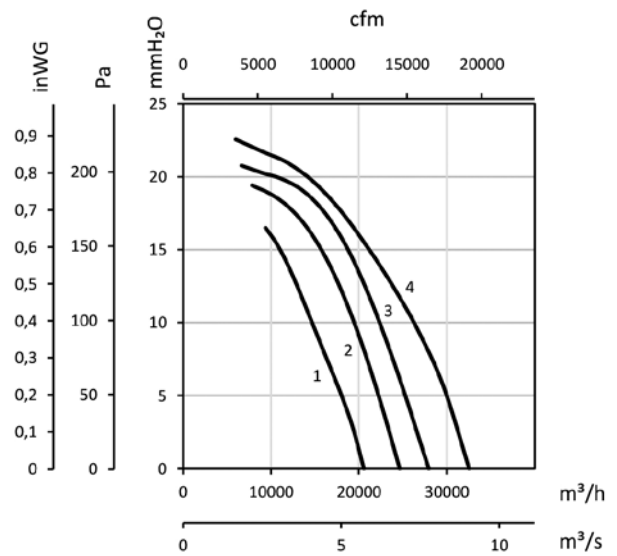

1 : HCH/ATEX-80-6T-1
2 : HCH/ATEX-80-6T-1.5
3 : HCH/ATEX-80-6T-2
4 : HCH/ATEX-80-6T-3

Ominaiskäyrät

Q= Ilmamäärä m³/h, m³/s ja cfm

Pe= Staattinen paine mmH₂O, Pa ja inwg

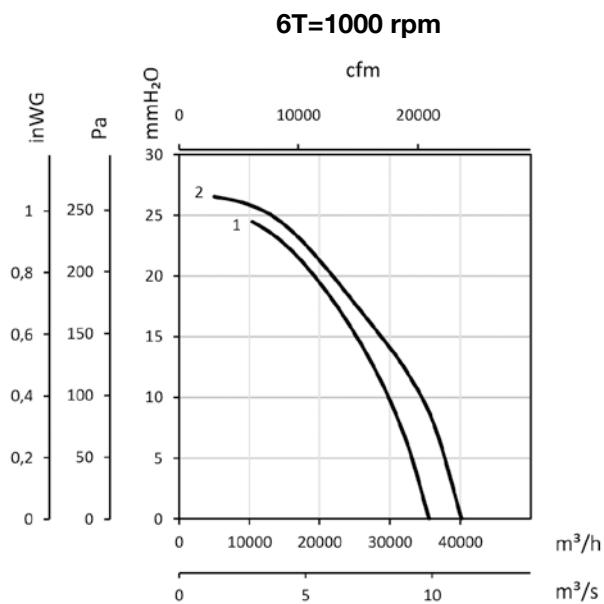

1 : HCH/ATEX-90-6T-3
2 : HCH/ATEX-90-6T-4

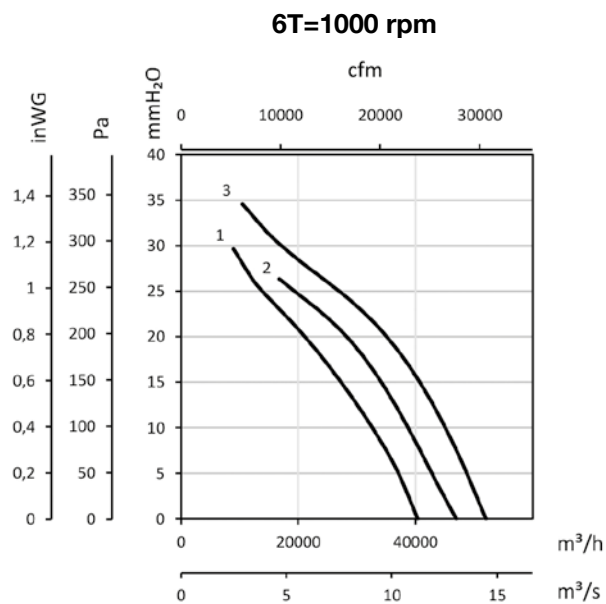

1 : HCH/ATEX-100-6T-3
2 : HCH/ATEX-100-6T-4
3 : HCH/ATEX-100-6T-5.5

Lisävarusteet



INT/ATEX



P



R

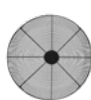

RI



PV



BTUB



PT



PT/H