

# HTMF

400 °C/2h (F400) ja 300 °C/2h (F300) savunpoistohuippumurit



400 °C/2h ja 300 °C/2h savunpoistohuippumurit. Voidaan asentaa palotilan sisälle. Suunniteltu teollisuus- tai vastaavien rakennusten savunpoistoon tulipalotilanteessa.

#### Puhallin:

- Jalusta sinkittyä ja maalattua terästä.
- Aseteltavasiipinen alumiinivalusiiپیpyörä.
- EN ISO 12499 standardin mukainen suoja verkko.
- Sadekatos sinkittyä ja maalattua terästä. Sertifioitu standardin EN 12101-3 mukaisesti, sertifikaattinumero 0370-CPR-0544 (F400) ja 0370-CPR-3073 (F300).

#### Moottori:

- H-eristysluokan moottorit S1 jatkuvaan käyttöön ja S2 lyhytaikaiseen käyttöön tulipalotilanteessa. Kuulalaakereilla ja IP55-suojaluokalla. 1- tai 2-nopeuksinen mallista riippuen.
- IE3-hyötysuhdeluokka alkaen 0,75 kW moottoritehosta, pois lukien 2-nopeuksiset ja 8-napaiset moottorit.
- Kolmivaiheinen 230/400 V 50 Hz (3 kW moottoritehoon asti), tai 400/690 V 50 Hz (yli 3 kW moottoritehoilla).
- Kuljetettavan ilman lämpötila: Ilmanvaihtokäytössä (S1): -25 °C... +50 °C. Savunpoistokäytössä (S2): maks. 300 °C/2h tai 400 °C/2h.

#### Pintakäsittely:

- Polyesterijauhemaalauus. Pohjakäsittelynä rasvanpoisto fosfaatitonta nanoteknologiaa käyttäen.

## Tilaukoodi

### Koot 56 - 100

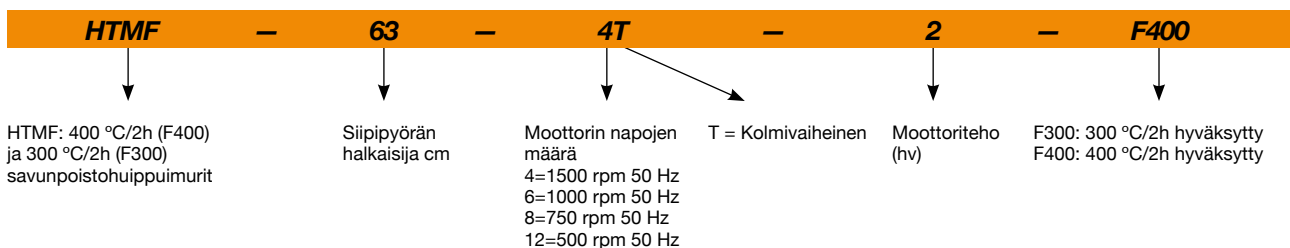

### Koko 125

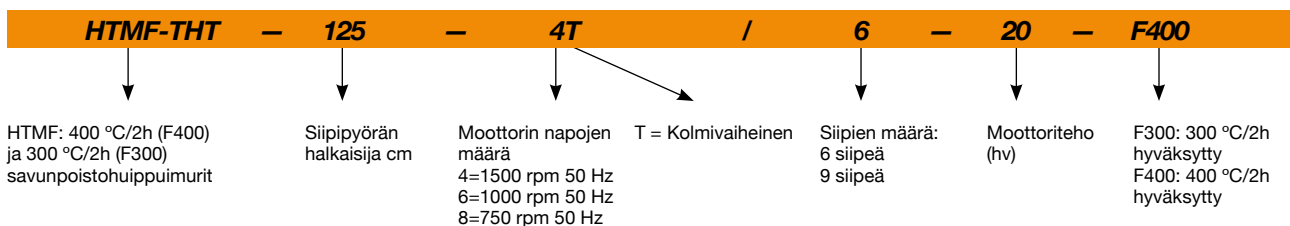

## Tekniset ominaisuudet

Malli	Pyörimisnopeus (rpm)	Nimellisvirta (A)			Moottoriteho (kW)	Maks. ilmamäärä (m <sup>3</sup> /h)	Äänenpainetaso <sup>1</sup> dB (A)		Paino noin (Kg)
		230V	400V	690V			Tulo	Poisto	
HTMF-56-4T-1 IE3	1410	3,08	1,79		0,75	10640	54	51	79
HTMF-56-4T-1.5 IE3	1430	4,10	2,37		1,10	11530	55	52	79
HTMF-56-4/8T-1.5	1420 / 695		2,69 / 1,12		1,10 / 0,25	11530 / 5620	55 / 39	52 / 36	79
HTMF-56-6T-0.75	930	2,90	1,75		0,55	8255	43	41	80
HTMF-63-4T-1.5 IE3	1430	4,10	2,37		1,10	13930	57	54	94
HTMF-63-4/8T-1.5	1420 / 695		2,69 / 1,12		1,10 / 0,25	13930 / 6800	57 / 41	54 / 38	94
HTMF-63-4T-2 IE3	1435	5,89	3,38		1,50	15630	58	55	96
HTMF-63-4/8T-2	1430 / 725		3,40 / 1,65		1,50 / 0,30	15630 / 7900	58 / 43	55 / 40	106
HTMF-63-4T-3 IE3	1450	7,86	4,52		2,20	18045	59	56	108
HTMF-63-4/8T-3	1430 / 705		4,80 / 1,85		2,20 / 0,45	18045 / 8900	59 / 44	56 / 41	112
HTMF-63-6T-0.75	930	2,90	1,75		0,55	10449	48	46	95
HTMF-63-6T-1 IE3	935	3,36	1,93		0,75	11355	49	47	95
HTMF-71-4T-2 IE3	1435	5,89	3,38		1,50	16370	61	58	109
HTMF-71-4/8T-2	1430 / 725		3,40 / 1,65		1,50 / 0,30	16370 / 8270	61 / 46	58 / 43	119
HTMF-71-4T-3 IE3	1450	7,86	4,52		2,20	18490	63	60	122
HTMF-71-4/8T-3	1430 / 705		4,80 / 1,85		2,20 / 0,45	18490 / 9120	63 / 48	60 / 45	125
HTMF-71-4T-4 IE3	1455	11,01	6,33		3,00	22685	64	61	133
HTMF-71-4/8T-4	1420 / 710		6,45 / 2,28		3,00 / 0,60	22685 / 11300	64 / 49	61 / 46	135
HTMF-71-6T-1 IE3	935	3,36	1,93		0,75	13410	50	48	109
HTMF-71-6T-1.5 IE3	930	4,73	2,72		1,10	16340	51	49	116
HTMF-80-4T-4 IE3	1455	11,01	6,33		3,00	27750	65	62	163
HTMF-80-4/8T-4	1420 / 710		6,45 / 2,28		3,00 / 0,60	27750 / 13820	65 / 50	62 / 47	165
HTMF-80-4T-5.5 IE3	1445		7,95	4,61	4,00	30330	66	63	163
HTMF-80-4/8T-5.5	1450 / 715		7,88 / 2,87		3,80 / 1,00	30330 / 14950	66 / 51	63 / 48	195
HTMF-80-6T-1.5 IE3	930	4,73	2,72		1,10	19435	54	52	181
HTMF-80-6T-2 IE3	950	6,25	3,62		1,50	22165	55	53	185
HTMF-80-6T-3 IE3	960	9,78	5,62		2,20	24890	56	54	191
HTMF-80-8T-1	710	5,06	2,92		0,75	16375	53	52	151
HTMF-90-4T-5.5 IE3	1445		7,95	4,61	4,00	35200	71	68	208
HTMF-90-4/8T-5.5	1450 / 715		7,88 / 2,87		3,80 / 1,00	35200 / 17360	71 / 56	68 / 53	238
HTMF-90-4T-7.5 IE3	1455		10,40	6,04	5,50	38535	73	70	240
HTMF-90-4/8T-7.5	1450 / 720		11,40 / 3,86		5,50 / 1,10	38535 / 19130	73 / 58	70 / 55	243
HTMF-90-4T-10 IE3	1460		14,20	8,17	7,50	41410	74	71	244
HTMF-90-4/8T-10	1450 / 720		15,10 / 5,16		7,50 / 1,50	41410 / 20560	74 / 59	71 / 56	243
HTMF-90-6T-3 IE3	960	9,78	5,62		2,20	29290	60	58	205
HTMF-90-6/12T-3	900 / 455		5,62 / 3,32		2,20 / 0,55	29290 / 14800	60 / 45	58 / 43	245
HTMF-90-6T-4 IE3	970	12,80	6,36		3,00	32040	61	59	235
HTMF-90-6/12T-4	900 / 450		7,37 / 3,53		2,80 / 0,70	32040 / 16020	61 / 46	59 / 44	245
HTMF-90-8T-1	710	5,06	2,92		0,75	17060	53	52	196
HTMF-90-8T-2	700	7,32	4,21		1,50	19635	55	54	208
HTMF-100-4T-7.5 IE3	1455		10,40	6,04	5,50	41060	76	73	265
HTMF-100-4/8T-7.5	1450 / 720		11,40 / 3,86		5,50 / 1,10	41060 / 20390	76 / 61	73 / 58	269
HTMF-100-4T-10 IE3	1460		14,20	8,17	7,50	47645	77	74	269
HTMF-100-4/8T-10	1450 / 720		15,10 / 5,16		7,50 / 1,50	44590 / 22140	76 / 61	73 / 58	269
HTMF-100-4T-15 IE3	1460		20,70	11,99	11,00	51375	78	75	332
HTMF-100-4/8T-14	1460 / 725		20,70 / 7,19		11,00 / 3,00	48400 / 24000	77 / 62	74 / 59	301
HTMF-100-6T-3 IE3	960	9,78	5,62		2,20	32600	66	64	231
HTMF-100-6/12T-3	900 / 455		5,62 / 3,32		2,20 / 0,55	32600 / 16470	66 / 51	64 / 49	271
HTMF-100-6T-4 IE3	970	12,80	6,36		3,00	35500	67	65	260
HTMF-100-6/12T-4	900 / 450		7,37 / 3,53		2,80 / 0,70	35500 / 17750	67 / 52	65 / 50	271
HTMF-100-6T-5.5 IE3	970		8,37	4,82	4,00	40035	68	66	277
HTMF-100-6/12T-5.5	900 / 445		9,54 / 4,27		3,80 / 1,00	40035 / 19710	68 / 53	66 / 51	289
HTMF-100-8T-3	705	9,30	5,35		2,20	26600	61	60	260
HTMF-100-8T-4	705	12,50	7,21		3,00	28900	62	61	270

## Tekniset ominaisuudet

Malli	Pyörimisnopeus (rpm)	Nimellisvirta (A)			Moottoriteho (kW)	Maks. ilmamäärä (m³/h)	Äänenpainetaso¹ dB (A)		Paino noin (Kg)
		230V	400V	690V			Tulo	Poisto	
HTMF-THT-125-4T/6-15 IE3	1460		20,70	11,99	11,00	66810	69	66	388
HTMF-THT-125-4T/6-20 IE3	1460		27,80	16,03	15,00	72900	69	66	410
HTMF-THT-125-4T/9-20 IE3	1460		27,80	16,03	15,00	76320	68	64	425
HTMF-THT-125-6T/6-5.5 IE3	970		8,37	4,82	4,00	47770	56	54	347
HTMF-THT-125-6T/6-7.5 IE3	970		12,30	7,07	5,50	55600	56	54	384
HTMF-THT-125-6T/6-10 IE3	970		15,20	8,83	7,50	66180	58	56	393
HTMF-THT-125-6T/6-15 IE3	970		22,50	13,07	11,00	76380	60	58	415
HTMF-THT-125-6T/9-7.5 IE3	970		12,30	7,07	5,50	50000	57	55	399
HTMF-THT-125-6T/9-10 IE3	970		15,20	8,83	7,50	59340	57	55	408
HTMF-THT-125-6T/9-15 IE3	970		22,50	13,07	11,00	71890	60	58	430
HTMF-THT-125-6T/9-20 IE3	970		29,00	16,78	15,00	83660	63	61	475
HTMF-THT-125-8T/6-4	705	12,50	7,21		3,00	47510	48	47	384
HTMF-THT-125-8T/6-5.5	720		9,84	5,70	4,00	52780	50	49	404
HTMF-THT-125-8T/6-7.5	720		13,17	7,59	5,50	60410	52	51	416
HTMF-THT-125-8T/6-10	720		17,40	10,10	7,50	66030	53	52	424
HTMF-THT-125-8T/9-5.5	720		9,84	5,70	4,00	51340	50	49	419
HTMF-THT-125-8T/9-7.5	720		13,17	7,59	5,50	54490	53	52	431
HTMF-THT-125-8T/9-10	720		17,40	10,10	7,50	65670	55	54	439
HTMF-THT-125-8T/9-15	730		23,30	13,50	11,00	73880	56	55	472

1 Melutason arvot ovat paineet dB(A), jotka on mitattu vapaassa kentässä 10 metrin etäisyydeltä.



## Erp. (Energy Related Products)

Direktiiviä 2009/125/EY koskevat tiedot voidaan ladata SODECA:n verkkosivulta tai QuickFan-valintaohjelmasta.

## Äänitiedot

Äänitehotaso Lw(A). Taulukossa on eritelty äänitehon arvot dB(A) oktaavikaistoittain (Hz)

Arvot mitattu sisääntulon aikana enimmäisvirtausnopeudella

	63	125	250	500	1000	2000	4000	8000
56-4-1	46	67	74	79	82	78	71	60
56-4-1.5	47	68	75	80	83	79	72	61
56-8-1.5 (2V)	31	52	59	64	67	63	56	45
56-6-0.75	35	56	63	68	71	67	60	49
63-4-1.5	49	70	77	82	85	81	74	63
63-8-1.5 (2V)	33	54	61	66	69	65	58	47
63-4-2	50	71	78	83	86	82	75	64
63-8-2 (2V)	35	56	63	68	71	67	60	49
63-4-3	51	72	79	84	87	83	76	65
63-8-3 (2V)	36	57	64	69	72	68	61	50
63-6-0.75	40	61	68	73	76	72	65	54
63-6-1	41	62	69	74	77	73	66	55
71-4-2	53	74	81	86	89	85	78	67
71-8-2 (2V)	38	59	66	71	74	70	63	52
71-4-3	55	76	83	88	91	87	80	69
71-8-3 (2V)	40	61	68	73	76	72	65	54
71-4-4	56	77	84	89	92	88	81	70
71-8-4 (2V)	41	62	69	74	77	73	66	55
71-6-1	42	63	70	75	78	74	67	56
71-6-1.5	43	64	71	76	79	75	68	57
80-4-4	57	78	85	90	93	89	82	71
80-8-4 (2V)	42	63	70	75	78	74	67	56
80-4-5.5	58	79	86	91	94	90	83	72
80-8-5.5 (2V)	43	64	71	76	79	75	68	57
80-6-1.5	46	67	74	79	82	78	71	60
80-6-2	47	68	75	80	83	79	72	61

Arvot mitattu poiston aikana enimmäisvirtausnopeudella

	63	125	250	500	1000	2000	4000	8000
56-4-1	43	64	71	76	79	75	68	57
56-4-1.5	44	65	72	77	80	76	69	58
56-8-1.5 (2V)	28	49	56	61	64	60	53	42
56-6-0.75	33	54	61	66	69	65	58	47
63-4-1.5	46	67	74	79	82	78	71	60
63-8-1.5 (2V)	30	51	58	63	66	62	55	44
63-4-2	47	68	75	80	83	79	72	61
63-8-2 (2V)	32	53	60	65	68	64	57	46
63-4-3	48	69	76	81	84	80	73	62
63-8-3 (2V)	33	54	61	66	69	65	58	47
63-6-0.75	38	59	66	71	74	70	63	52
63-6-1	39	60	67	72	75	71	64	53
71-4-2	50	71	78	83	86	82	75	64
71-8-2 (2V)	35	56	63	68	71	67	60	49
71-4-3	52	73	80	85	88	84	77	66
71-8-3 (2V)	37	58	65	70	73	69	62	51
71-4-4	53	74	81	86	89	85	78	67
71-8-4 (2V)	38	59	66	71	74	70	63	52
71-6-1	40	61	68	73	76	72	65	54
71-6-1.5	41	62	69	74	77	73	66	55
80-4-4	54	75	82	87	90	86	79	68
80-8-4 (2V)	39	60	67	72	75	71	64	53
80-4-5.5	55	76	83	88	91	87	80	69
80-8-5.5 (2V)	40	61	68	73	76	72	65	54
80-6-1.5	44	65	72	77	80	76	69	58
80-6-2	45	66	73	78	81	77	70	59

## Äänitiedot

Äänitehotaso Lw(A). Taulukossa on eritelty äänitehon arvot dB(A) oktaavikaistoittain (Hz)

Arvot mitattu sisääntulon aikana enimmäisvirtausnopeudella

	63	125	250	500	1000	2000	4000	8000
80-6-3	48	69	76	81	84	80	73	62
80-8-1	45	66	73	78	81	77	70	59
90-4-5.5	63	84	91	96	99	95	88	77
90-8-5.5 (2V)	48	69	76	81	84	80	73	62
90-4-7.5	65	86	93	98	101	97	90	79
90-8-7.5 (2V)	50	71	78	83	86	82	75	64
90-4-10	66	87	94	99	102	98	91	80
90-8-10 (2V)	51	72	79	84	87	83	76	65
90-6-3	52	73	80	85	88	84	77	66
90-12-3 (2V)	37	58	65	70	73	69	62	51
90-6-4	53	74	81	86	89	85	78	67
90-12-4 (2V)	38	59	66	71	74	70	63	52
90-8-1	45	66	73	78	81	77	70	59
90-8-2	47	68	75	80	83	79	72	61
100-4-7.5	68	89	96	101	104	100	93	82
100-8-7.5 (2V)	53	74	81	86	89	85	78	67
100-4-10	68	89	96	101	104	100	93	82
100-8-10 (2V)	53	74	81	86	89	85	78	67
100-4-14	69	90	97	102	105	101	94	83
100-8-14 (2V)	54	75	82	87	90	86	79	68
100-4-15	70	91	98	103	106	102	95	84
100-6-3	58	79	86	91	94	90	83	72
100-12-3 (2V)	43	64	71	76	79	75	68	57
100-6-4	59	80	87	92	95	91	84	73
100-12-4 (2V)	44	65	72	77	80	76	69	58
100-6-5.5	60	81	88	93	96	92	85	74
100-12-5.5 (2V)	45	66	73	78	81	77	70	59
100-8-3	53	74	81	86	89	85	78	67
100-8-4	54	75	82	87	90	86	79	68
125-4/6-15	63	72	87	94	97	91	85	81
125-4/6-20	63	72	87	94	97	91	85	81
125-4/9-20	62	71	87	93	95	89	84	80
125-6/6-5.5	56	66	78	81	83	79	68	64
125-6/6-7.5	56	66	78	81	83	79	68	64
125-6/6-10	58	68	80	83	85	81	70	66
125-6/6-15	60	70	82	85	87	83	72	68
125-6/9-7.5	54	65	79	83	83	81	70	66
125-6/9-10	54	65	79	83	83	81	70	66
125-6/9-15	57	68	82	86	86	84	73	69
125-6/9-20	60	71	85	89	89	87	76	72
125-8/6-4	50	59	70	75	75	69	58	54
125-8/6-5.5	52	61	72	77	77	71	60	56
125-8/6-7.5	54	63	74	79	79	73	62	58
125-8/6-10	55	64	75	80	80	74	63	59
125-8/9-5.5	49	61	70	76	78	72	61	57
125-8/9-7.5	52	64	73	79	81	75	64	60
125-8/9-10	54	66	75	81	83	77	66	62
125-8/9-15	55	67	76	82	84	78	67	63

Arvot mitattu poiston aikana enimmäisvirtausnopeudella

	63	125	250	500	1000	2000	4000	8000
80-6-3	46	67	74	79	82	78	71	60
80-8-1	44	65	72	77	80	76	69	58
90-4-5.5	60	81	88	93	96	92	85	74
90-8-5.5 (2V)	45	66	73	78	81	77	70	59
90-4-7.5	62	83	90	95	98	94	87	76
90-8-7.5 (2V)	47	68	75	80	83	79	72	61
90-4-10	63	84	91	96	99	95	88	77
90-8-10 (2V)	48	69	76	81	84	80	73	62
90-6-3	50	71	78	83	86	82	75	64
90-12-3 (2V)	35	56	63	68	71	67	60	49
90-6-4	51	72	79	84	87	83	76	65
90-12-4 (2V)	36	57	64	69	72	68	61	50
90-8-1	44	65	72	77	80	76	69	58
90-8-2	46	67	74	79	82	78	71	60
100-4-7.5	65	86	93	98	101	97	90	79
100-8-7.5 (2V)	50	71	78	83	86	82	75	64
100-4-10	65	86	93	98	101	97	90	79
100-8-10 (2V)	50	71	78	83	86	82	75	64
100-4-14	66	87	94	99	102	98	91	80
100-8-14 (2V)	51	72	79	84	87	83	76	65
100-4-15	67	88	95	100	103	99	92	81
100-6-3	56	77	84	89	92	88	81	70
100-12-3 (2V)	41	62	69	74	77	73	66	55
100-6-4	57	78	85	90	93	89	82	71
100-12-4 (2V)	42	63	70	75	78	74	67	56
100-6-5.5	58	79	86	91	94	90	83	72
100-12-5.5 (2V)	43	64	71	76	79	75	68	57
100-8-3	52	73	80	85	88	84	77	66
100-8-4	53	74	81	86	89	85	78	67
125-4/6-15	60	69	84	91	94	88	82	78
125-4/6-20	60	69	84	91	94	88	82	78
125-4/9-20	59	68	84	90	92	86	81	77
125-6/6-5.5	54	64	76	79	81	77	66	62
125-6/6-7.5	54	64	76	79	81	77	66	62
125-6/6-10	56	66	78	81	83	79	68	64
125-6/6-15	58	68	80	83	85	81	70	66
125-6/9-7.5	52	63	77	81	81	79	68	64
125-6/9-10	52	63	77	81	81	79	68	64
125-6/9-15	55	66	80	84	84	82	71	67
125-6/9-20	58	69	83	87	87	85	74	70
125-8/6-4	49	58	69	74	74	68	57	53
125-8/6-5.5	51	60	71	76	76	70	59	55
125-8/6-7.5	53	62	73	78	78	72	61	57
125-8/6-10	54	63	74	79	79	73	62	58
125-8/9-5.5	48	60	69	75	77	71	60	56
125-8/9-7.5	51	63	72	78	80	74	63	59
125-8/9-10	53	65	74	80	82	76	65	61
125-8/9-15	54	66	75	81	83	77	66	62

## Mitat mm

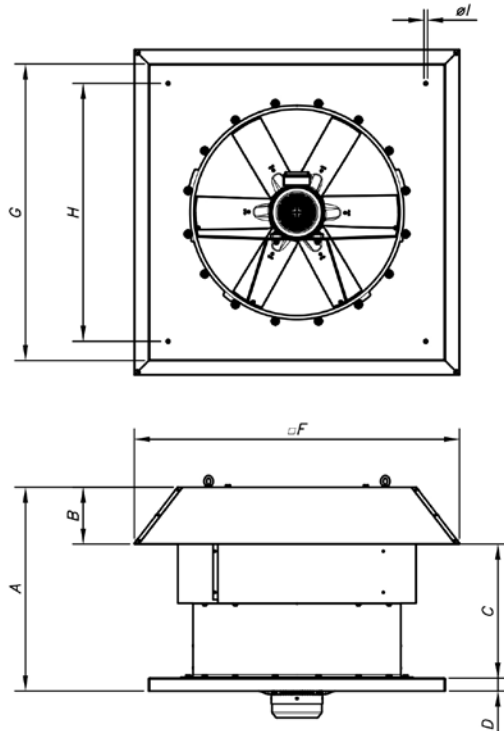

	A	B	C	D	F	G	H	ØI
HTMF-56	650	185	425	40	960	900	750	14
HTMF-63	680	215	425	40	1092	1000	850	14
HTMF-71	759	195	524	40	1120	1000	850	14
HTMF-80	790	216	524	50	1252	1150	1000	14
HTMF-90	920	232	638	50	1380	1150	1000	14
HTMF-100	1055	252	753	50	1527	1250	1100	14
HTMF-125	1170	311	809	50	1803	1425	1275	17

## Ominaiskäyrät

Q= Ilmamäärä m<sup>3</sup>/h, m<sup>3</sup>/s ja cfm

Pe= Staattinen paine mmH<sub>2</sub>O, Pa ja inwg

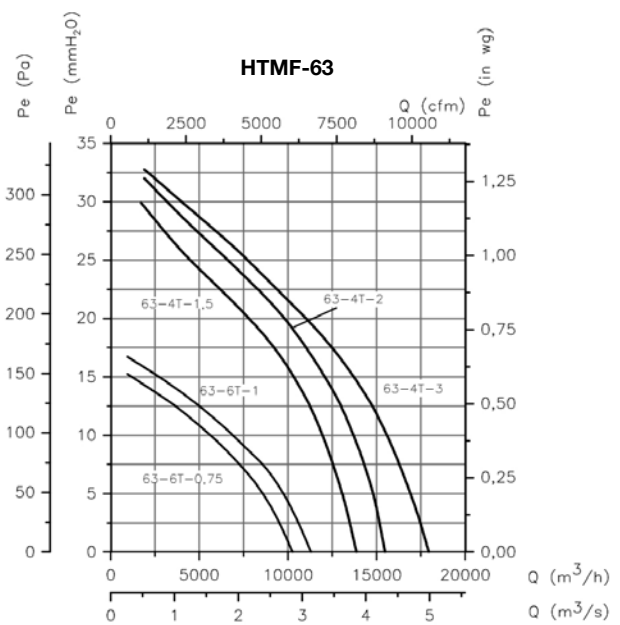
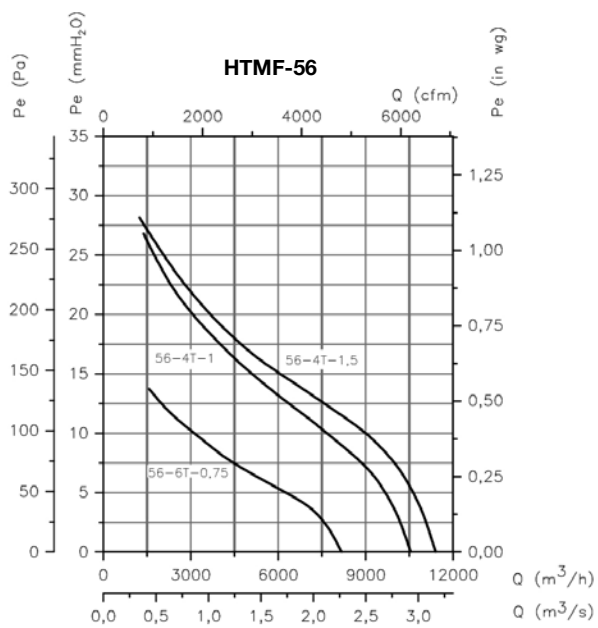

## Ominaiskäyrät

Q= Ilmämäärä m<sup>3</sup>/h, m<sup>3</sup>/s ja cfm

Pe= Staattinen paine mmH<sub>2</sub>O, Pa ja inwg

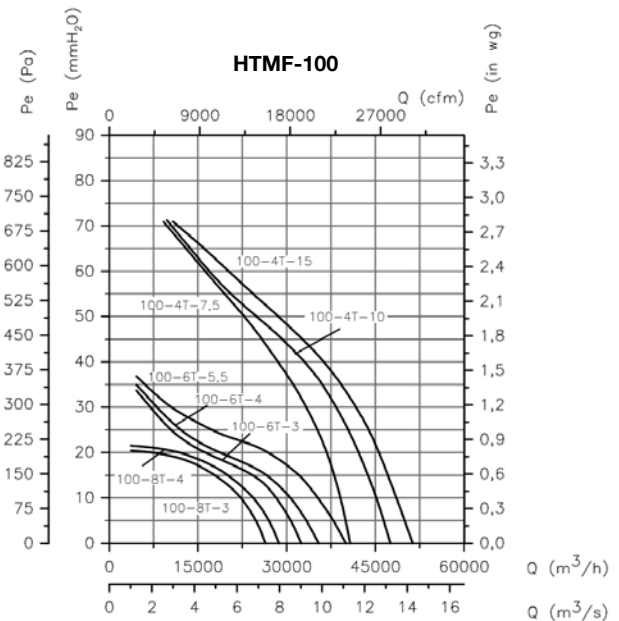
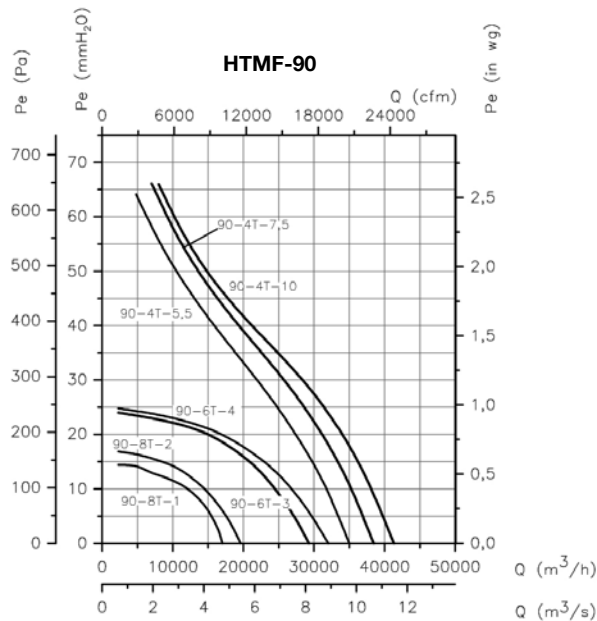
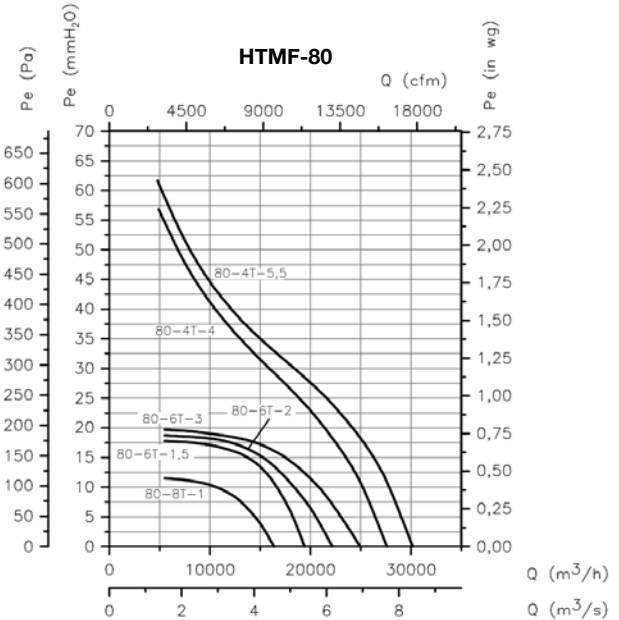
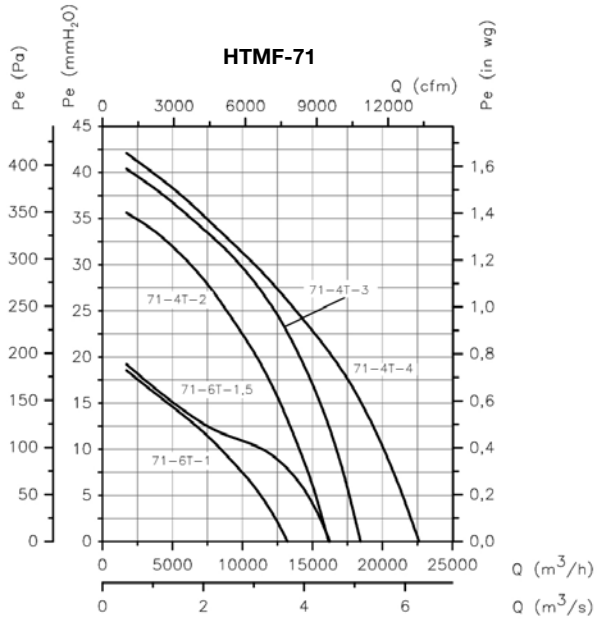

## Ominaiskäyrät

Q= Ilmamäärä m<sup>3</sup>/h, m<sup>3</sup>/s ja cfm

Pe= Staattinen paine mmH<sub>2</sub>O, Pa ja inwg

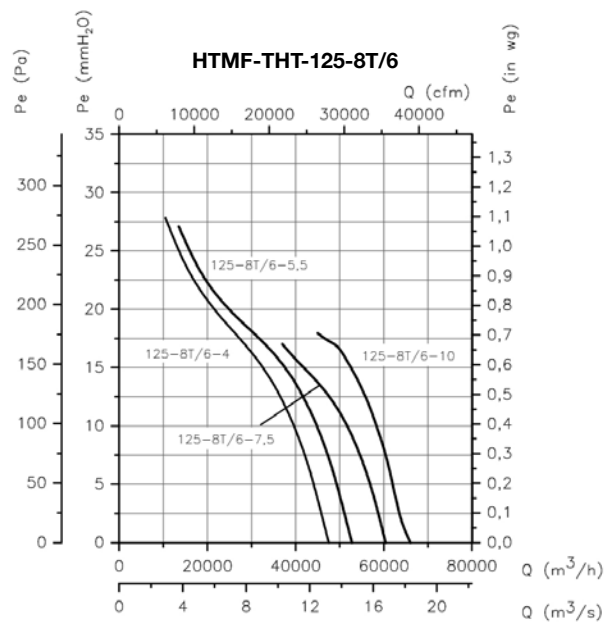
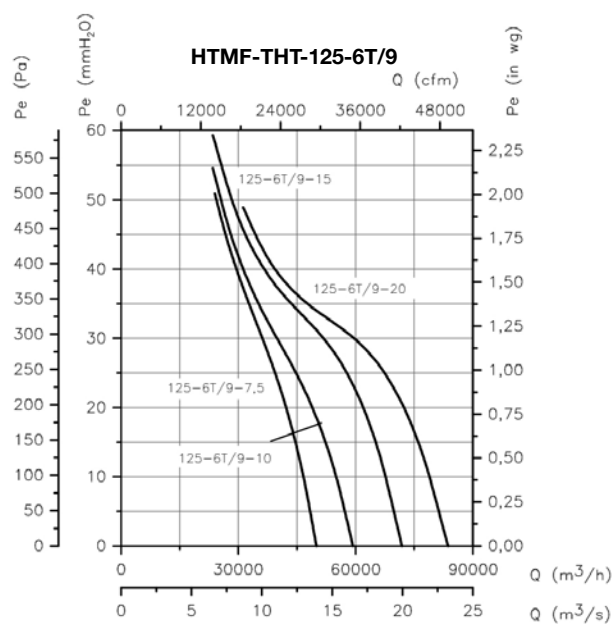
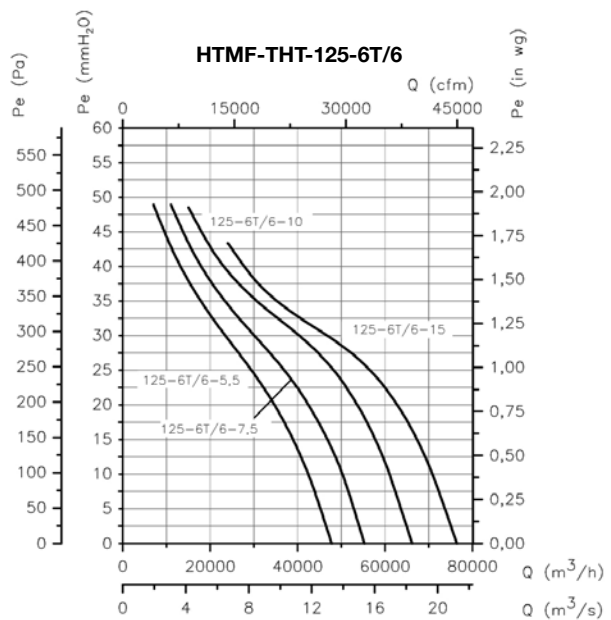
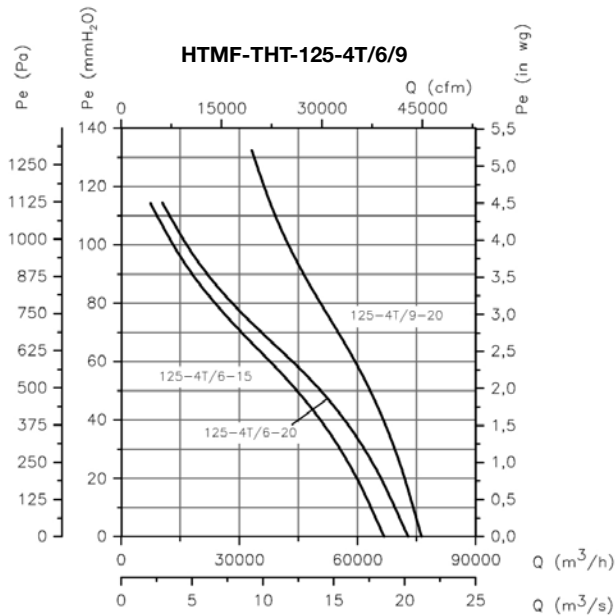

## Ominaiskäyrät

Q= Ilmamäärä m<sup>3</sup>/h, m<sup>3</sup>/s ja cfm

Pe= Staattinen paine mmH<sub>2</sub>O, Pa ja inwg

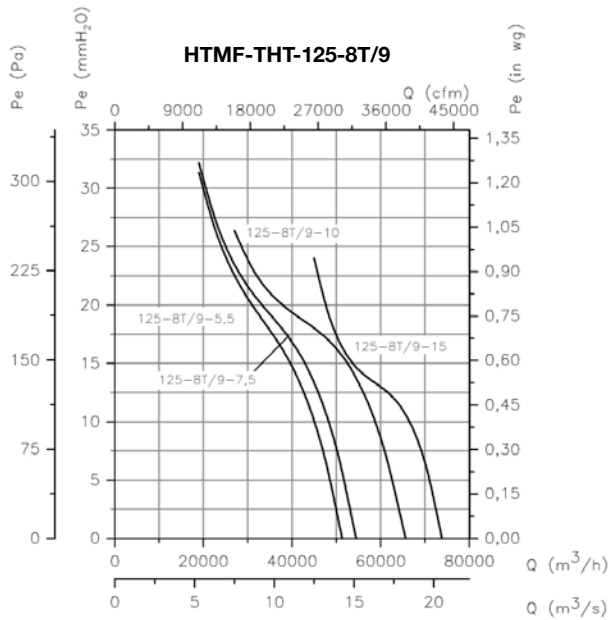

## Äänenpaineen vaihtelu etäisyydestä riippuen

Melutaso voi vaihdella katto- tai kansirakenteesta riippuen.

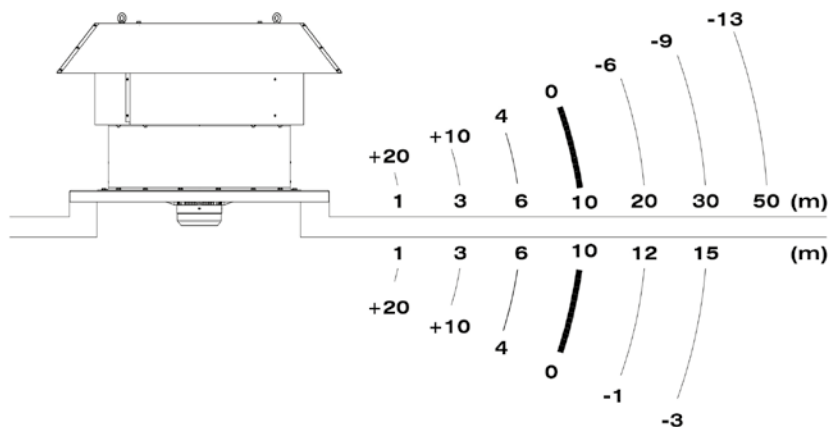

## Lisävarusteet



INT



IAT



CABLE BOX



C2V



VSD3/A-RFT  
- VSD1/A-RFM



CENTRAL CO



AET

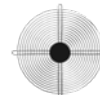

RT