

CJBD/EC/C



Ventilation units with circular inlet and outlet and EC Technology IE4 motor with integrated electronics



Ventilation units with forward curved impeller and EC Technology IE4 motor with integrated electronics, specially designed to obtain high energy efficiency.

- Single-phase 190-250 V 50/60 Hz.
- Working temperature: -25 °C +60 °C.

Finish:

- Anti-corrosive in galvanized steel sheet.

Fan:

- Galvanized steel sheet casing.
- Forward curved impeller in galvanized sheet steel.

Motor:

- High efficiency EC Technology motors with integrated electronics, regulated by 0-10 V.
- IE4 efficiency motors, class F and IP54 protection.



With support foot to facilitate mounting.



EC TECHNOLOGY MOTOR with integrated electronics

Order code

CJBD/EC/C	—	2525	—	4M	—	3/4	—	IE4
↓		↓		↓	↓	↓		↓
CJBD/EC/C: Ventilation units with circular inlet and outlet and EC Technology IE4 motor with integrated electronics		Impeller size mm mm inch 1919 7/7 2525 9/9 2828 10/10 3333 12/12		Number of motor poles 4=1400 r/min 50 Hz 6=900 r/min 50 Hz	M = Single-phase	Motor power (HP)		IE4 motor

Technical characteristics

Model	Equivalence inches	Max. speed (r/min)	Maximum admissible current (A)	Max. electric power (kW)	Maximum flow rate (m³/h)	Sound pressure level dB (A)	Approx. weight (Kg)	According ErP
			230V					
CJBD/EC/C-1919-4M-1/5 IE4	7/7	1400	1.65	0.18	1520	60	21	2018
CJBD/EC/C-1919-6M-1/10 IE4	7/7	900	0.98	0.09	1374	55	21	2018
CJBD/EC/C-2525-4M-1/2 IE4	9/9	1400	1.64	0.37	2400	68	24	2018
CJBD/EC/C-2525-4M-3/4 IE4	9/9	1400	2.37	0.55	3200	72	25	2018
CJBD/EC/C-2525-4M-1 IE4	9/9	1400	3.12	0.75	4200	73	26	2018
CJBD/EC/C-2525-6M-1/3 IE4	9/9	900	1.07	0.25	2785	63	25	2018
CJBD/EC/C-2828-4M-1 IE4	10/10	1400	4.12	0.75	3827	74	30	2018
CJBD/EC/C-2828-4M-2 IE4	10/10	1400	11.04	1.50	5915	76	32	2018
CJBD/EC/C-2828-6M-1/3 IE4	10/10	900	1.10	0.25	3046	63	31	2018
CJBD/EC/C-3333-6M-1 IE4	12/12	900	7.83	1.10	5200	72	45	2018



Erp. (Energy Related Products)

Information on Directive 2009/125/EC can be downloaded from the SODECA website or the QuickFan selector programme.

Acoustic characteristics

The indicated values are determined by measuring the sound pressure level and sound power in dB(A) obtained in a free field at a distance equivalent to twice the size of the fan plus the impeller diameter, with a minimum of 1.5 m.

Sound power spectrum Lw(A) in dB(A) per Hz frequency band

	63	125	250	500	1000	2000	4000	8000
1919-4M-1/5 IE4	45	56	60	64	66	65	64	55
1919-6M-1/10 IE4	40	51	55	59	61	60	59	50
2525-4M-1/2 IE4	53	64	68	72	74	73	72	63
2525-4M-3/4 IE4	57	68	72	76	78	77	76	67
2525-4M-1 IE4	58	69	73	77	79	78	77	68
2525-6M-1/3 IE4	48	59	63	67	69	68	67	58
2828-4M-1 IE4	59	70	74	78	80	79	78	69
2828-4M-2 IE4	61	72	76	80	82	81	80	71
2828-6M-1/3 IE4	48	59	63	67	69	68	67	58
3333-6M-1 IE4	57	68	72	76	78	77	76	67

Dimensions mm

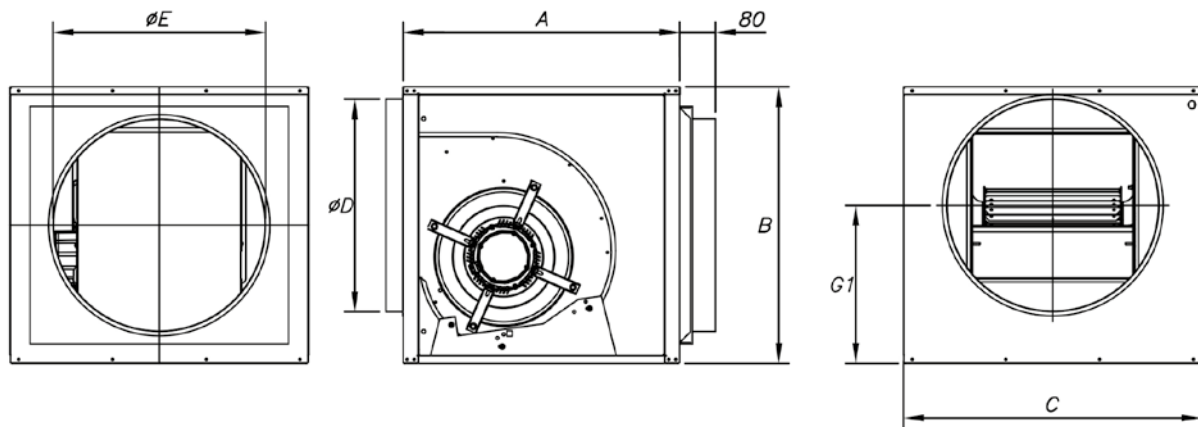

	Equivalence inches	A	B	C	øD	øE	G1
CJBD/EC/C-1919	7/7	450	460	500	250	250	245
CJBD/EC/C-2525	9/9	500	522	550	355	355	283.5
CJBD/EC/C-2828	10/10	550	575	600	400	400	324.5
CJBD/EC/C-3333	12/12	650	650	700	500	500	372.5

Characteristic curves

See series characteristic curves: CBD/EC

Accessories



Characteristic curves

Q= Flow rate in m³/h, m³/s and cfm

Pe= Static pressure in mm H₂O, Pa and inwg

1919-4M-1/5 IE4

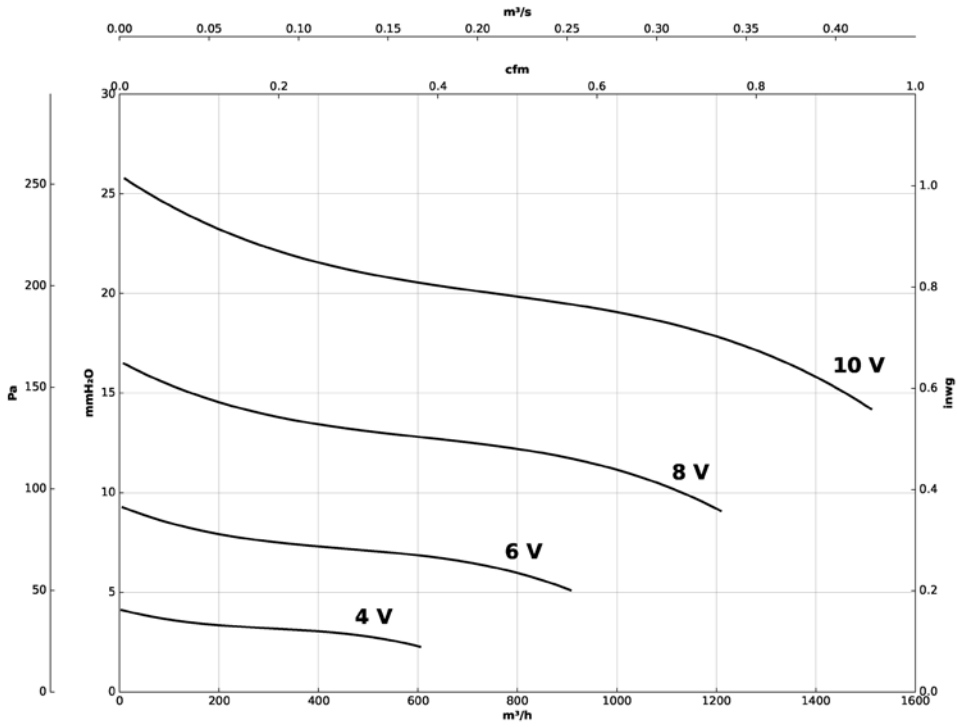

1919-6M-1/10 IE4

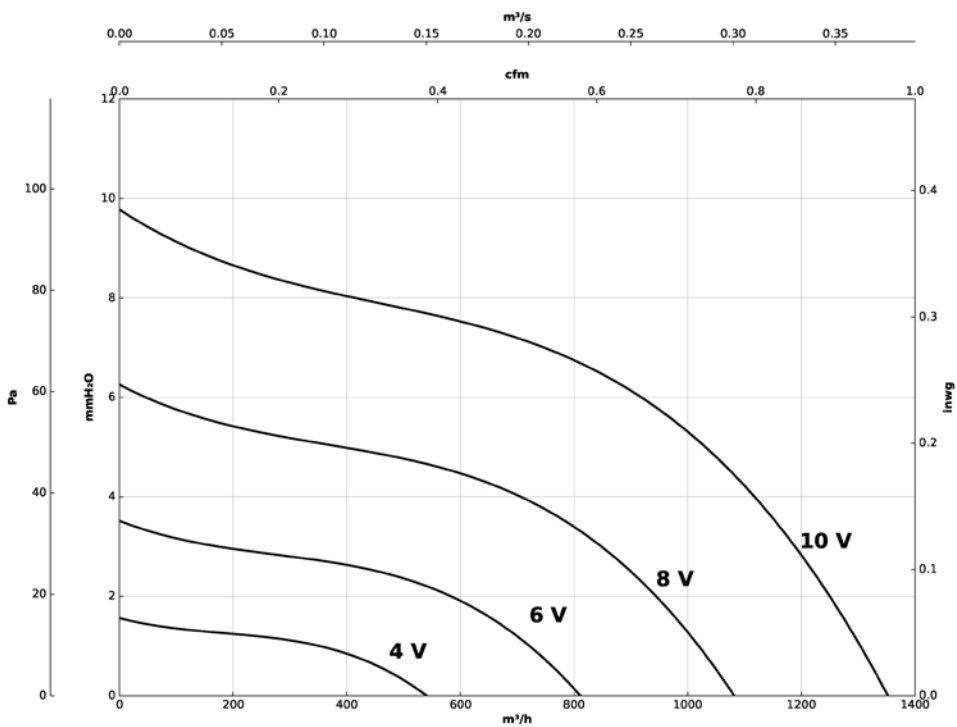

Characteristic curves

Q= Flow rate in m³/h, m³/s and cfm

Pe= Static pressure in mm H₂O, Pa and inwg

2525-4M-1/2 IE4

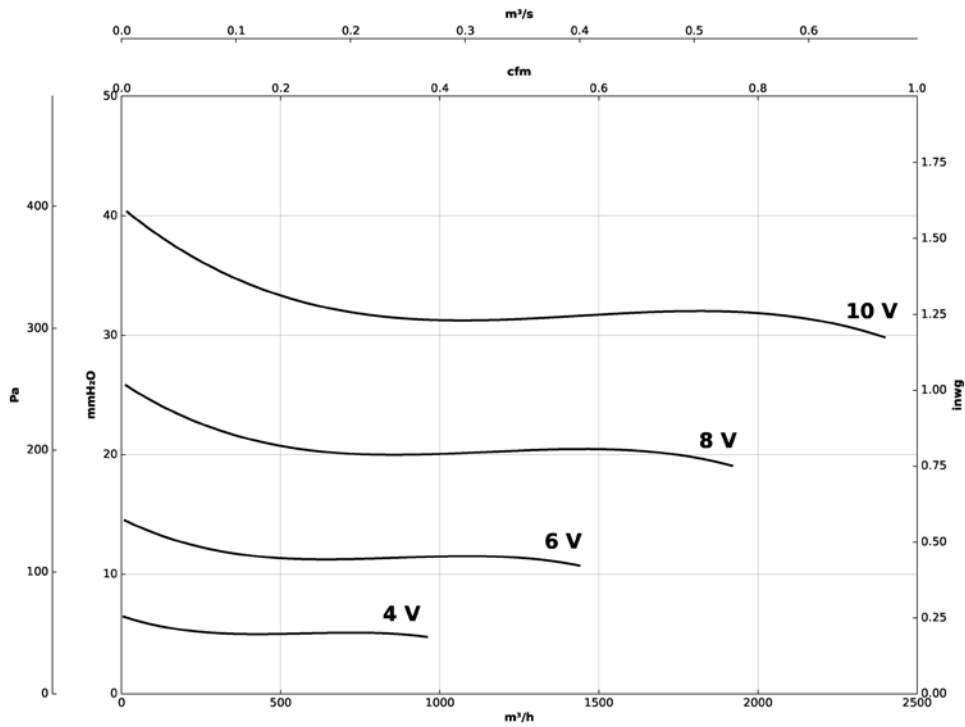

2525-4M-3/4 IE4

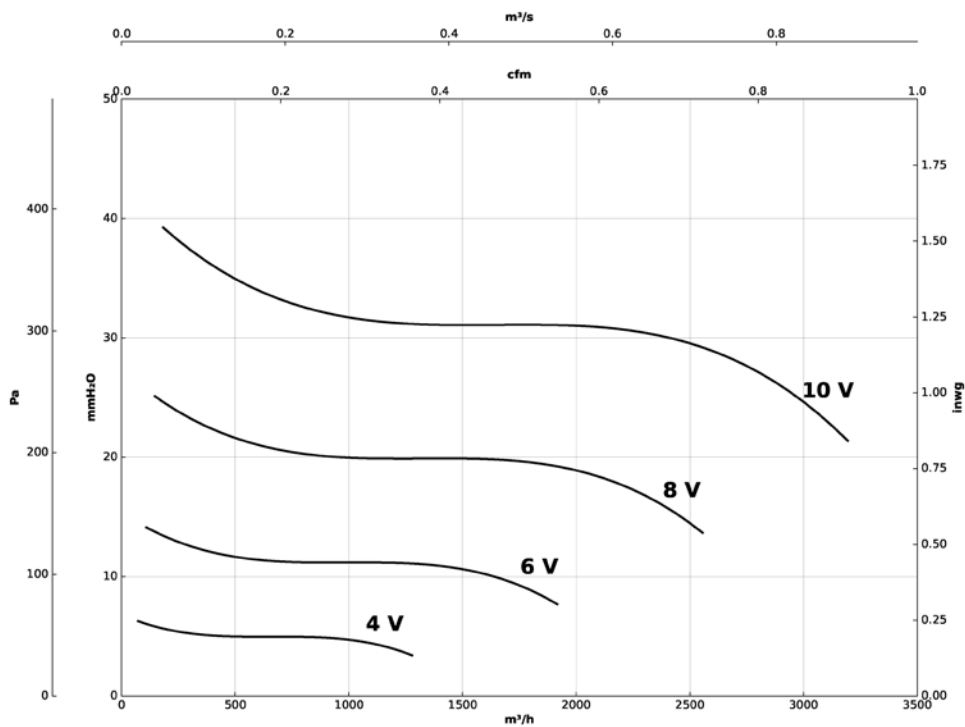

Characteristic curves

Q= Flow rate in m³/h, m³/s and cfm

Pe= Static pressure in mm H₂O, Pa and inwg

2525-4M-1 IE4

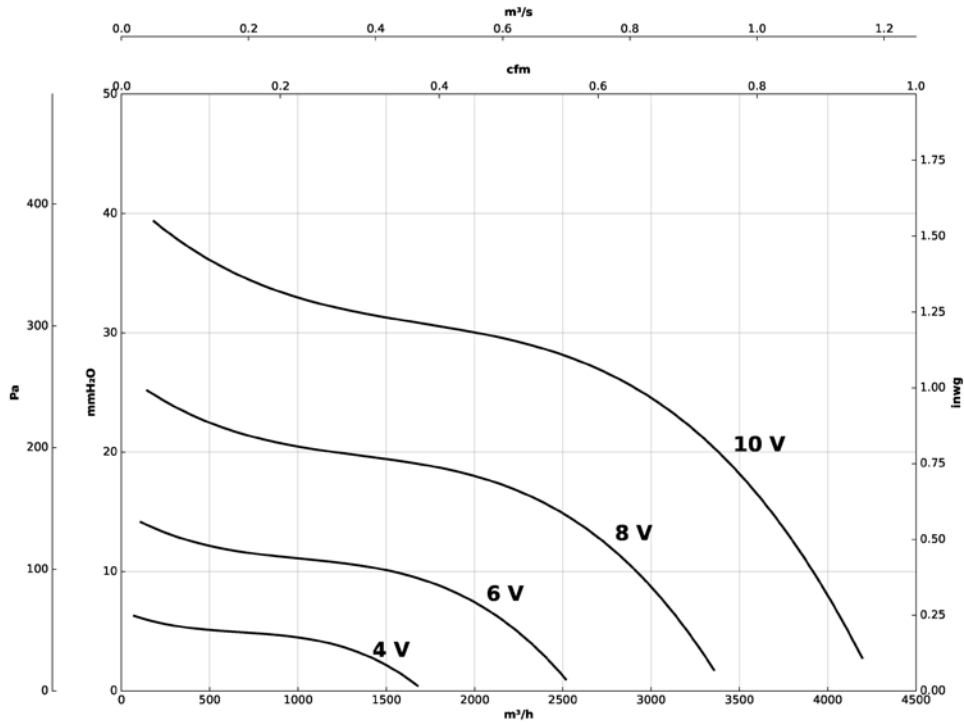

2525-6M-1/3 IE4

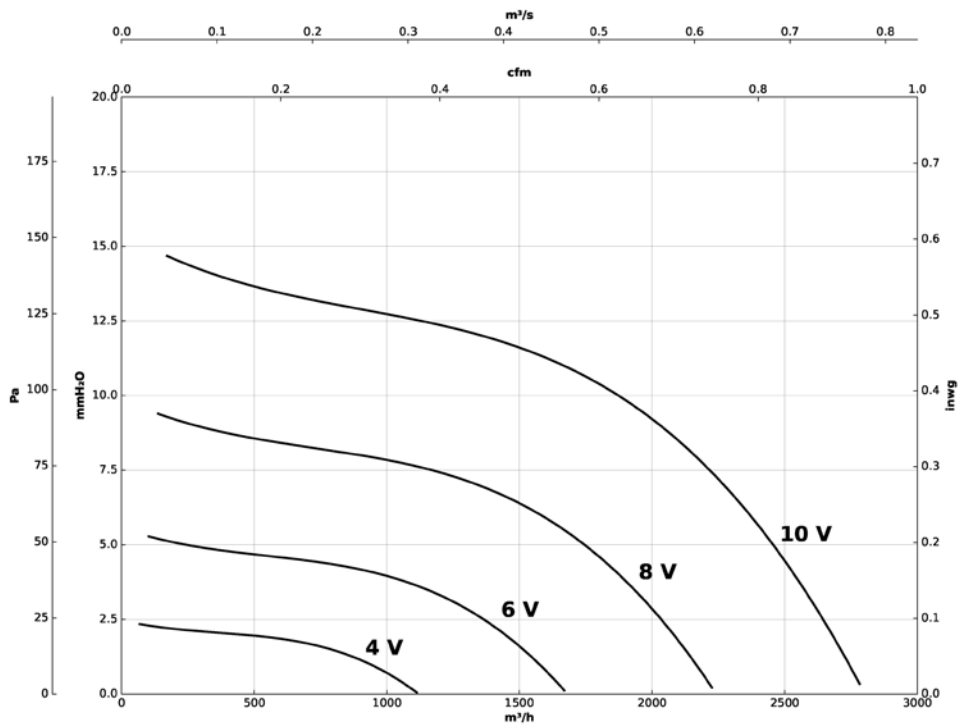

Characteristic curves

Q= Flow rate in m³/h, m³/s and cfm

Pe= Static pressure in mm H₂O, Pa and inwg

2828-4M-1 IE4

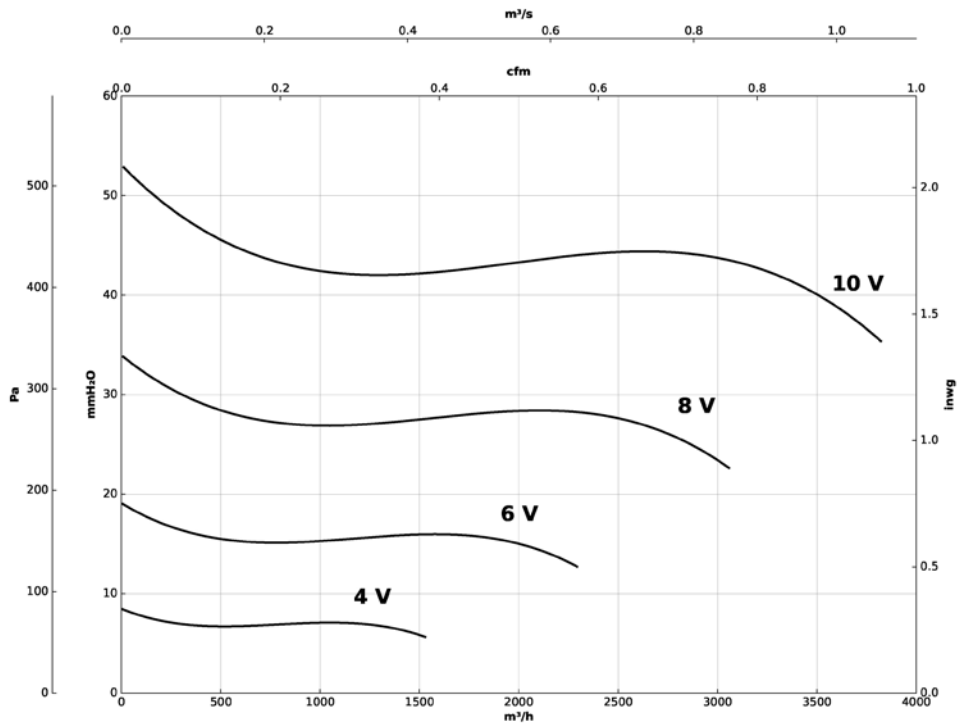

2828-4M-2 IE4

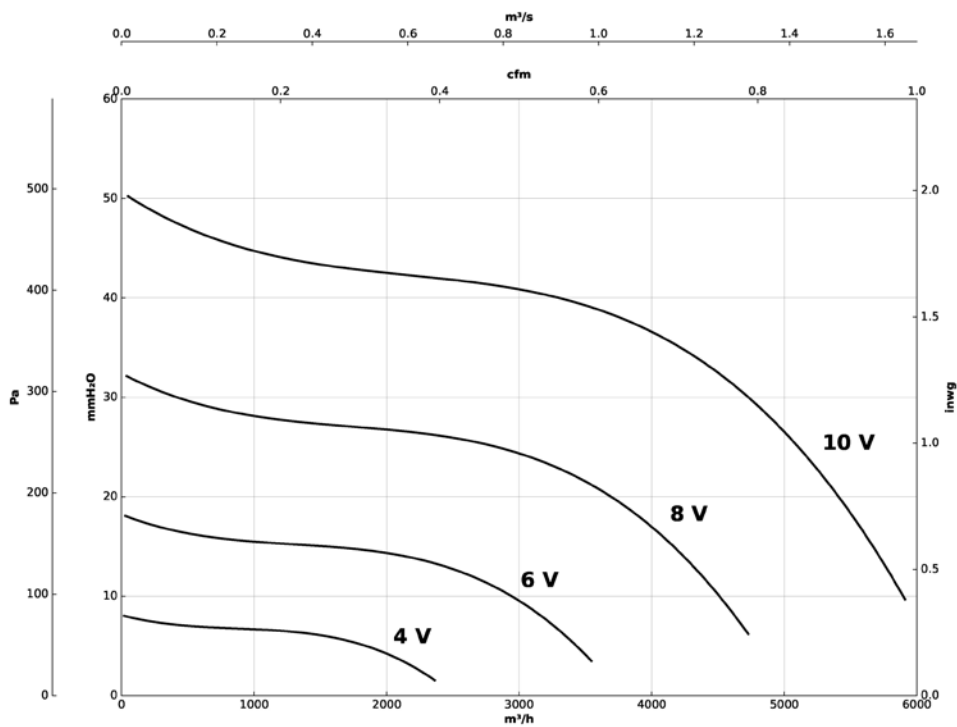

Characteristic curves

Q= Flow rate in m³/h, m³/s and cfm

Pe= Static pressure in mm H₂O, Pa and inwg

2828-6M-1/3 IE4

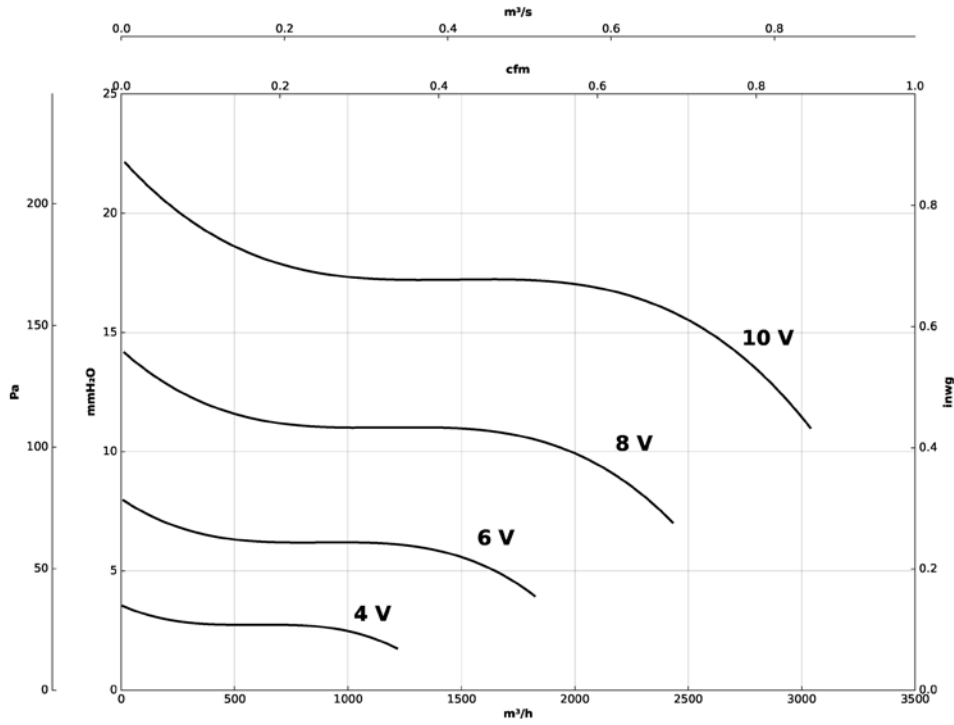

3333-6M-1 IE4

